



US008787536B1

(12) **United States Patent**
Lavian et al.

(10) **Patent No.:** **US 8,787,536 B1**
(45) **Date of Patent:** ***Jul. 22, 2014**

(54) **SYSTEMS AND METHODS FOR COMMUNICATING WITH AN INTERACTIVE VOICE RESPONSE SYSTEM**

(71) Applicants: **Tal Lavian**, Sunnyvale, CA (US); **Zvi Or-Bach**, San Jose, CA (US)

(72) Inventors: **Tal Lavian**, Sunnyvale, CA (US); **Zvi Or-Bach**, San Jose, CA (US)

(*) Notice: Subject to any disclaimer, the term of this patent is extended or adjusted under 35 U.S.C. 154(b) by 0 days.

This patent is subject to a terminal disclaimer.

(21) Appl. No.: **13/958,641**

(22) Filed: **Aug. 5, 2013**

Related U.S. Application Data

(63) Continuation of application No. 13/046,532, filed on Mar. 11, 2011, now Pat. No. 8,548,131.

(51) **Int. Cl.**
H04M 11/00 (2006.01)
H04M 3/53 (2006.01)

(52) **U.S. Cl.**
CPC **H04M 3/5315** (2013.01)
USPC **379/88.13**; 379/88.18

(58) **Field of Classification Search**
USPC 379/88.13, 88.18
See application file for complete search history.

(56) **References Cited**

U.S. PATENT DOCUMENTS

6,292,480 B1 *	9/2001	May	370/352
6,920,425 B1 *	7/2005	Will et al.	704/275
7,054,939 B2 *	5/2006	Koch et al.	709/227
7,065,188 B1 *	6/2006	Mei et al.	379/88.23
7,551,782 B2 *	6/2009	Haim Lev	382/209
7,702,083 B2 *	4/2010	Erhart et al.	379/88.22
7,813,485 B2 *	10/2010	Yin et al.	379/88.13
8,539,354 B2 *	9/2013	Beswick et al.	715/719

* cited by examiner

Primary Examiner — Simon Sing

(57) **ABSTRACT**

Embodiments of the present invention provide a communication device. The communication device comprises a processor. Further, the communication device comprises a memory coupled to the processor. The memory comprises a database comprising at least one visual Interactive Voice Response (IVR) menu associated with at least one IVR system. Further, the memory comprises instructions executable by the processor for sending a first section of a data packet to a second communication device. The first section comprising first information is sent based on a visual IVR menu associated with the second communication device. Further, the memory comprises instructions executable by the processor for receiving an acknowledgement message from the second communication device based on the first section of the data packet. Furthermore, the memory includes instructions executable by the processor for sending a second section of the data packet to the second communication device based on the acknowledgement message. The second section comprises second information.

20 Claims, 11 Drawing Sheets

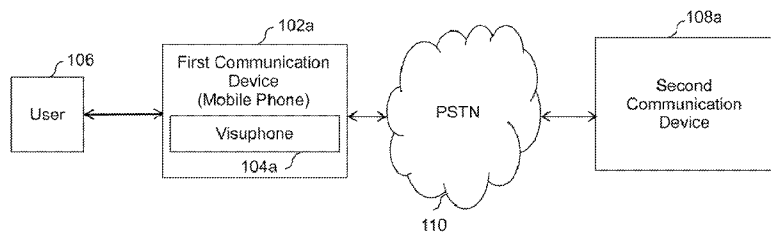

↗
100

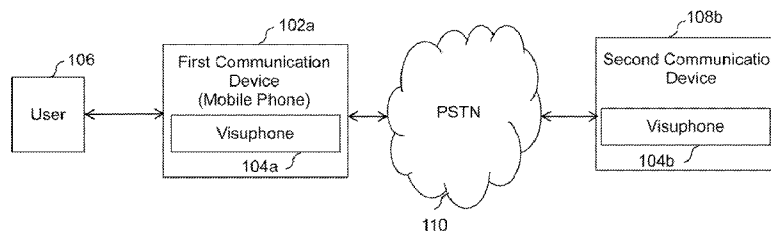

↗
100

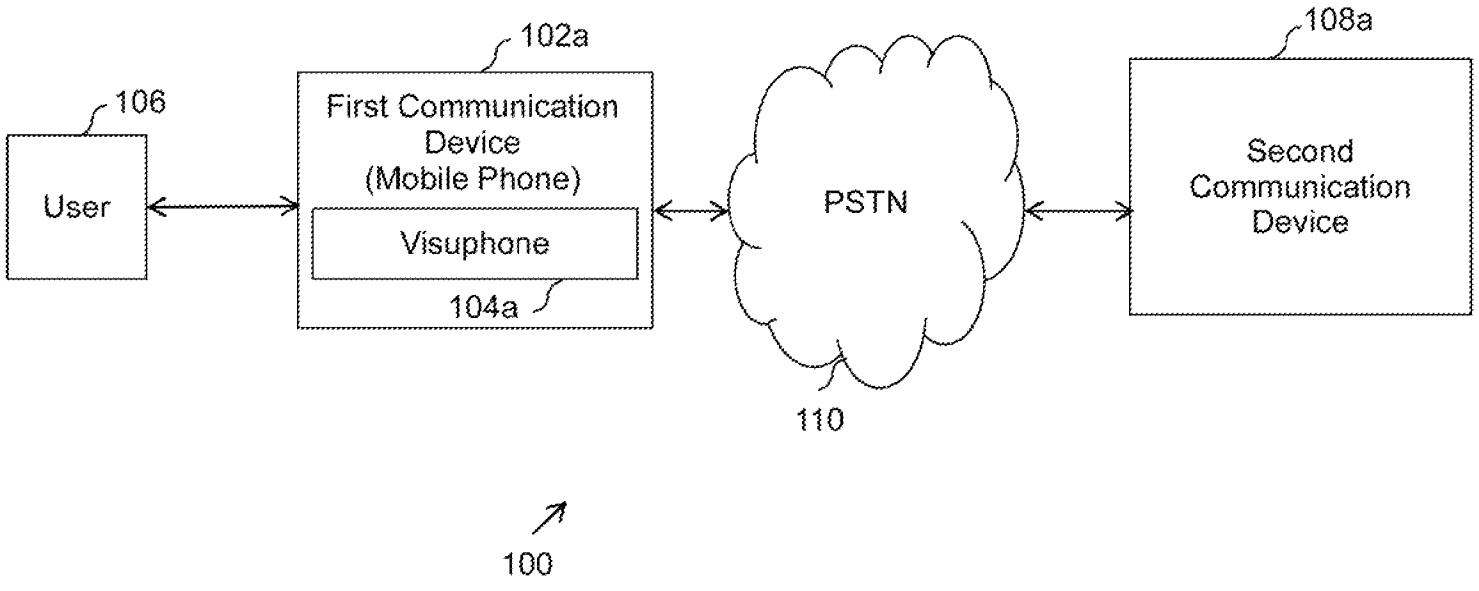

FIG. 1A

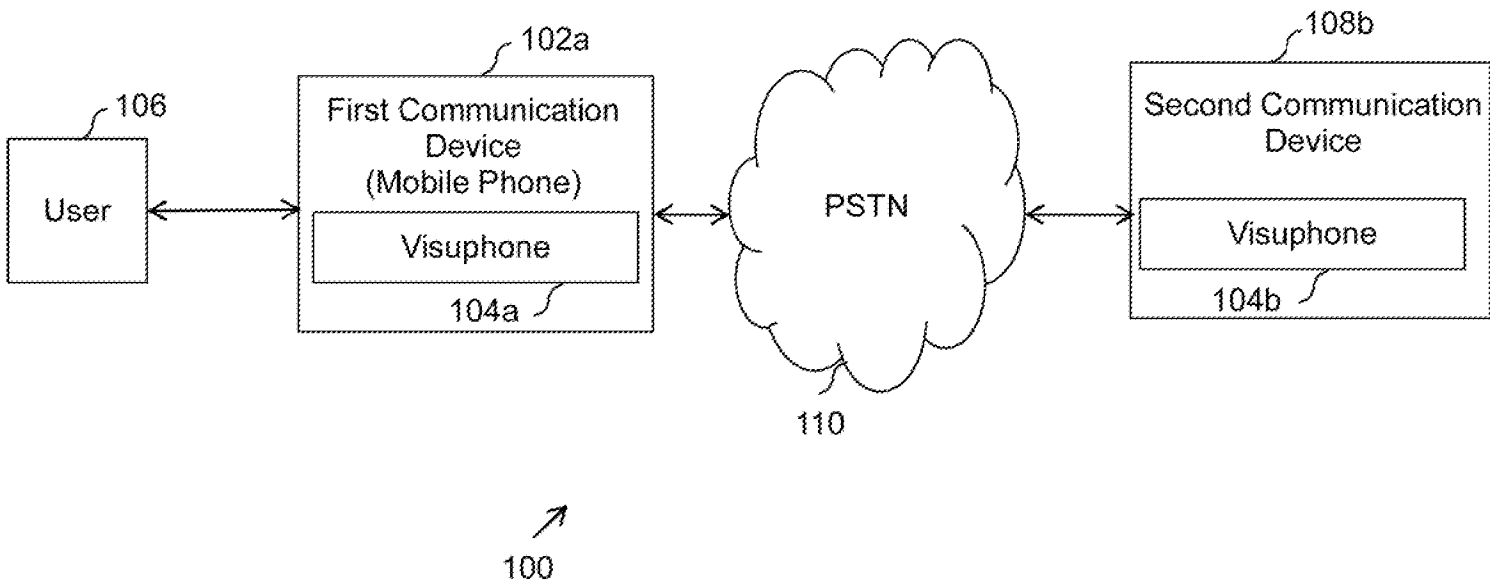

FIG. 1B

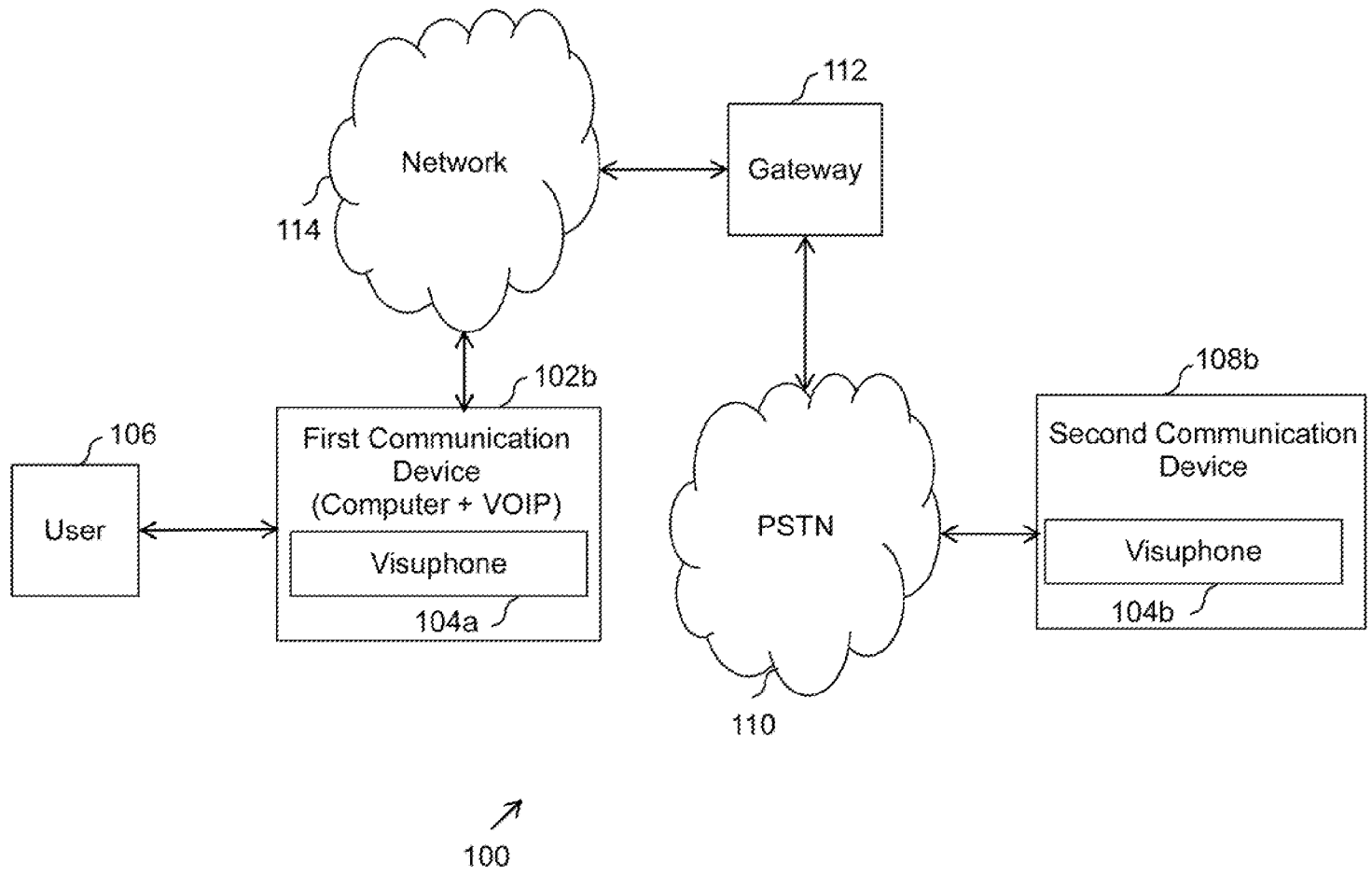

FIG. 1C

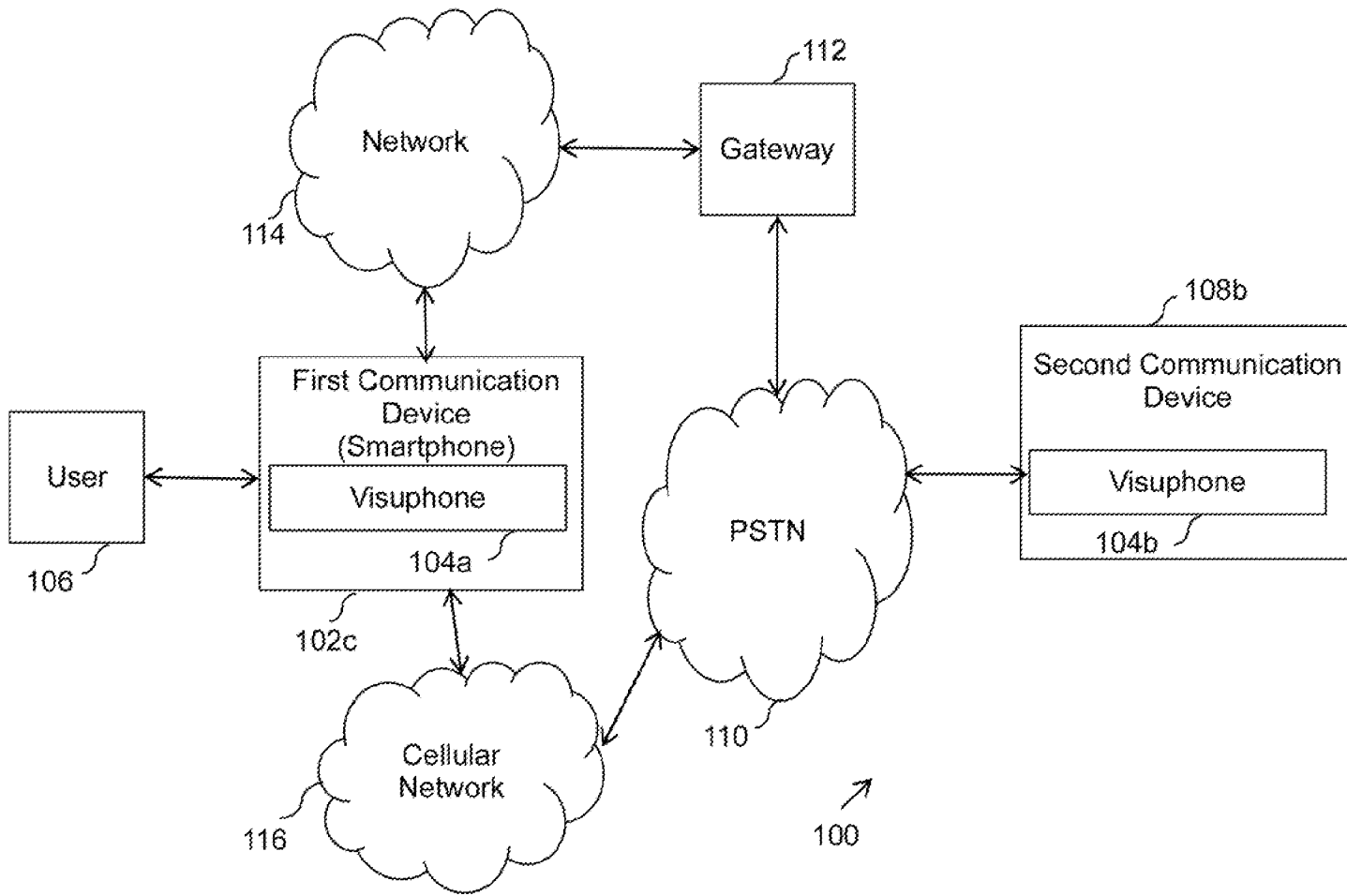

FIG. 1D

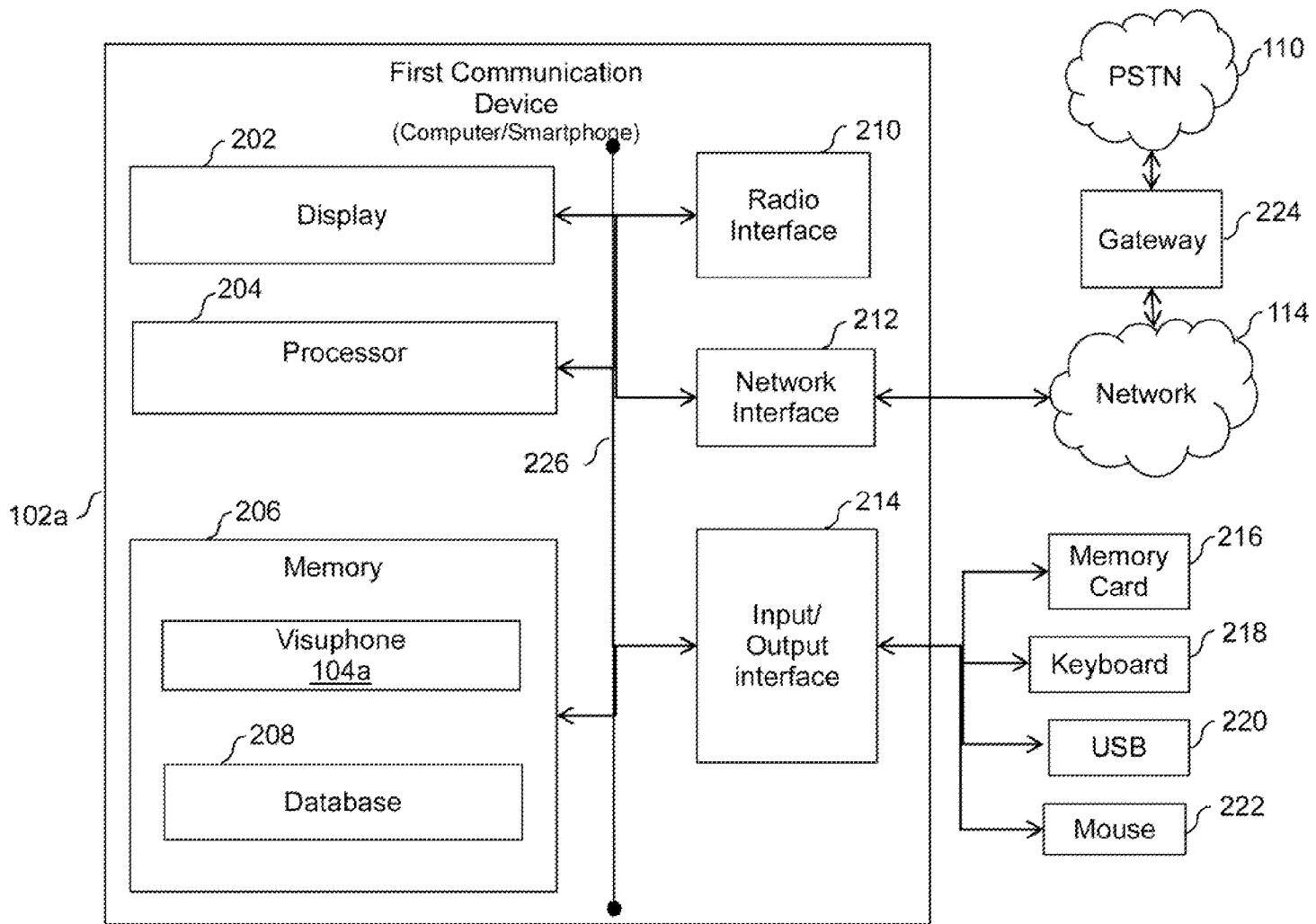

FIG. 2A

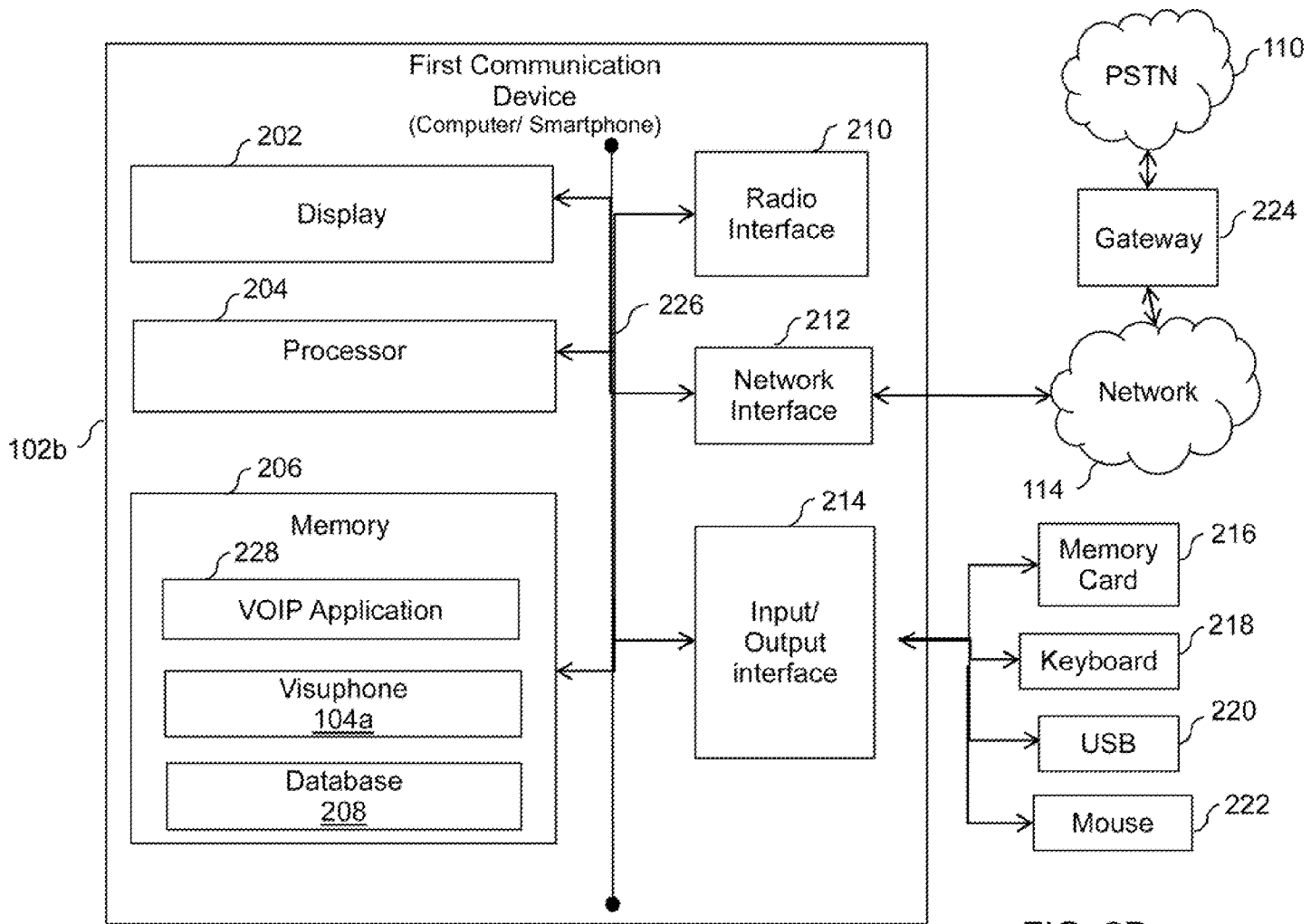

FIG. 2B

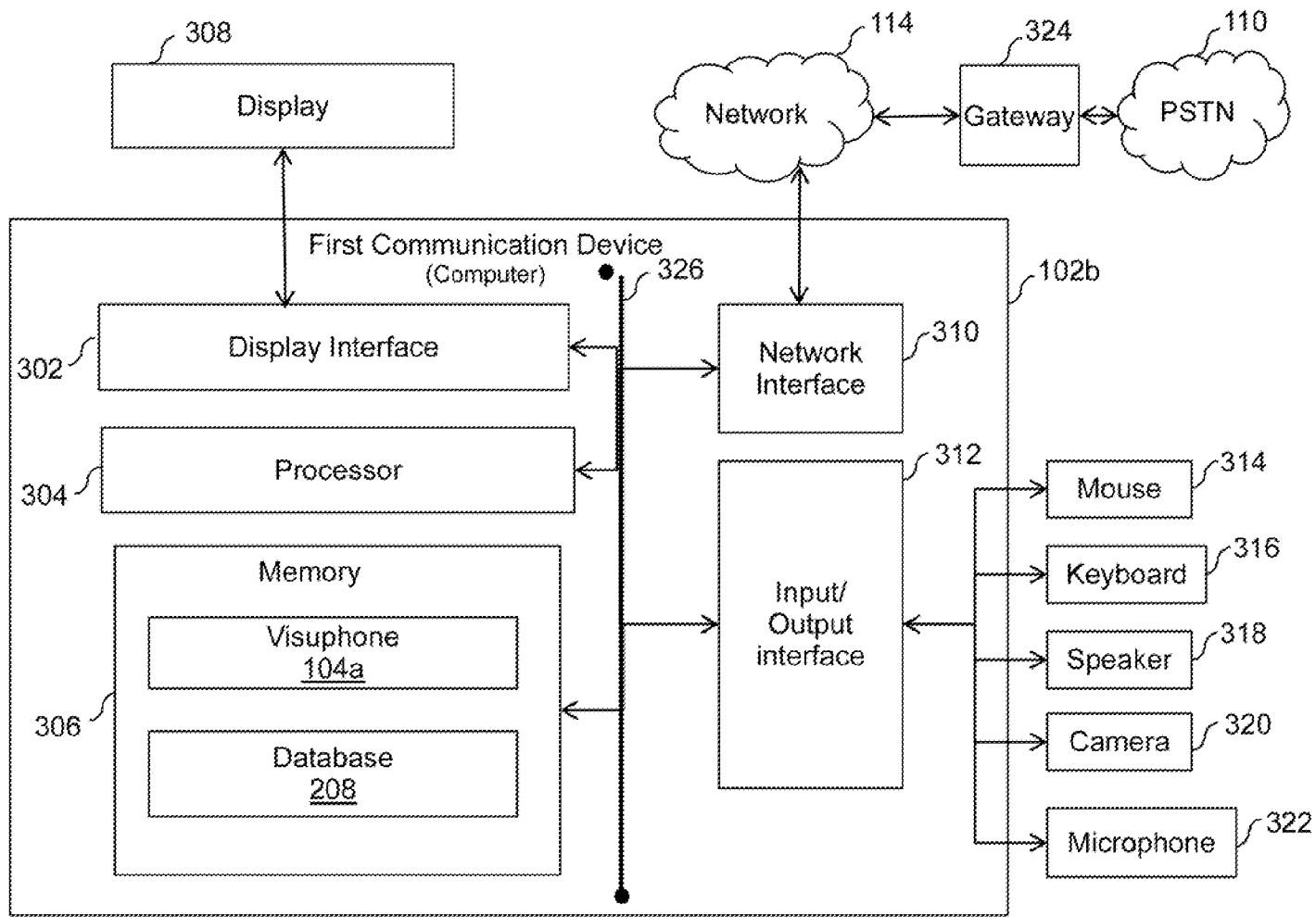

FIG. 3

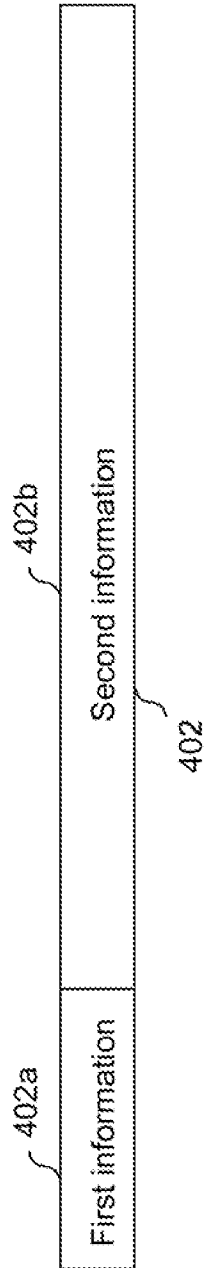
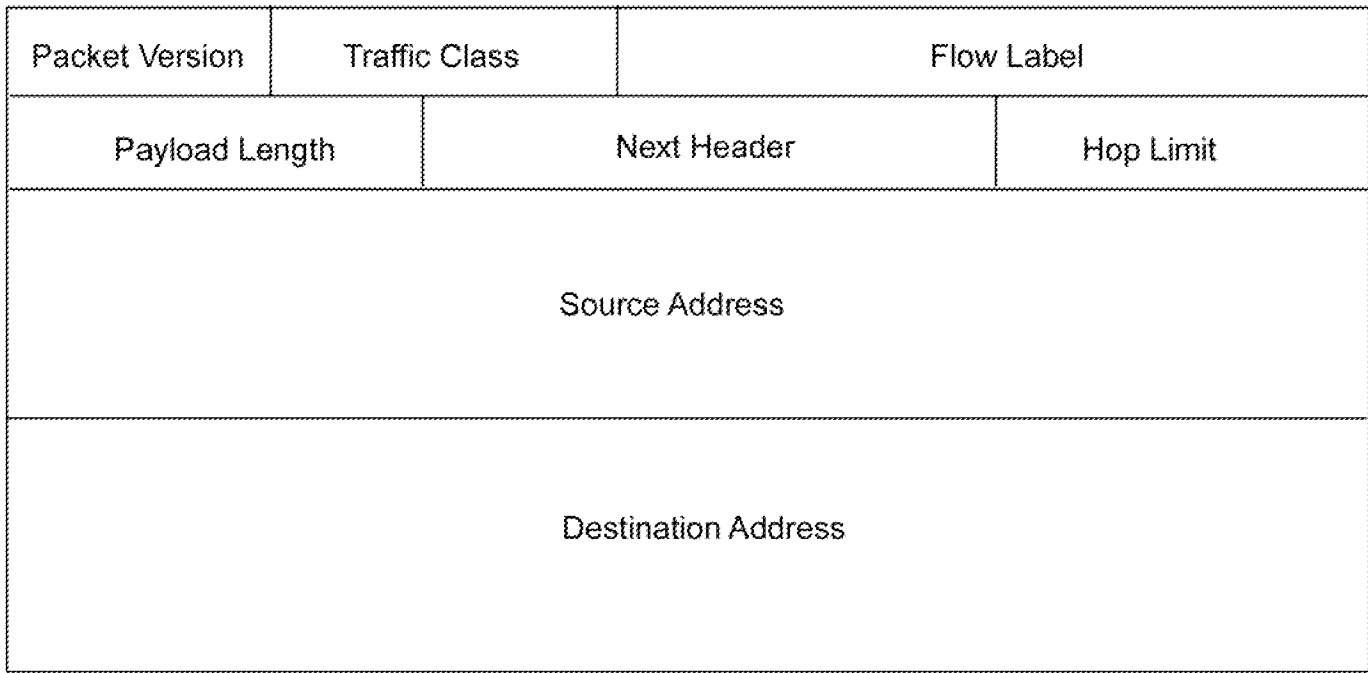

FIG. 4A



402a

FIG. 4B

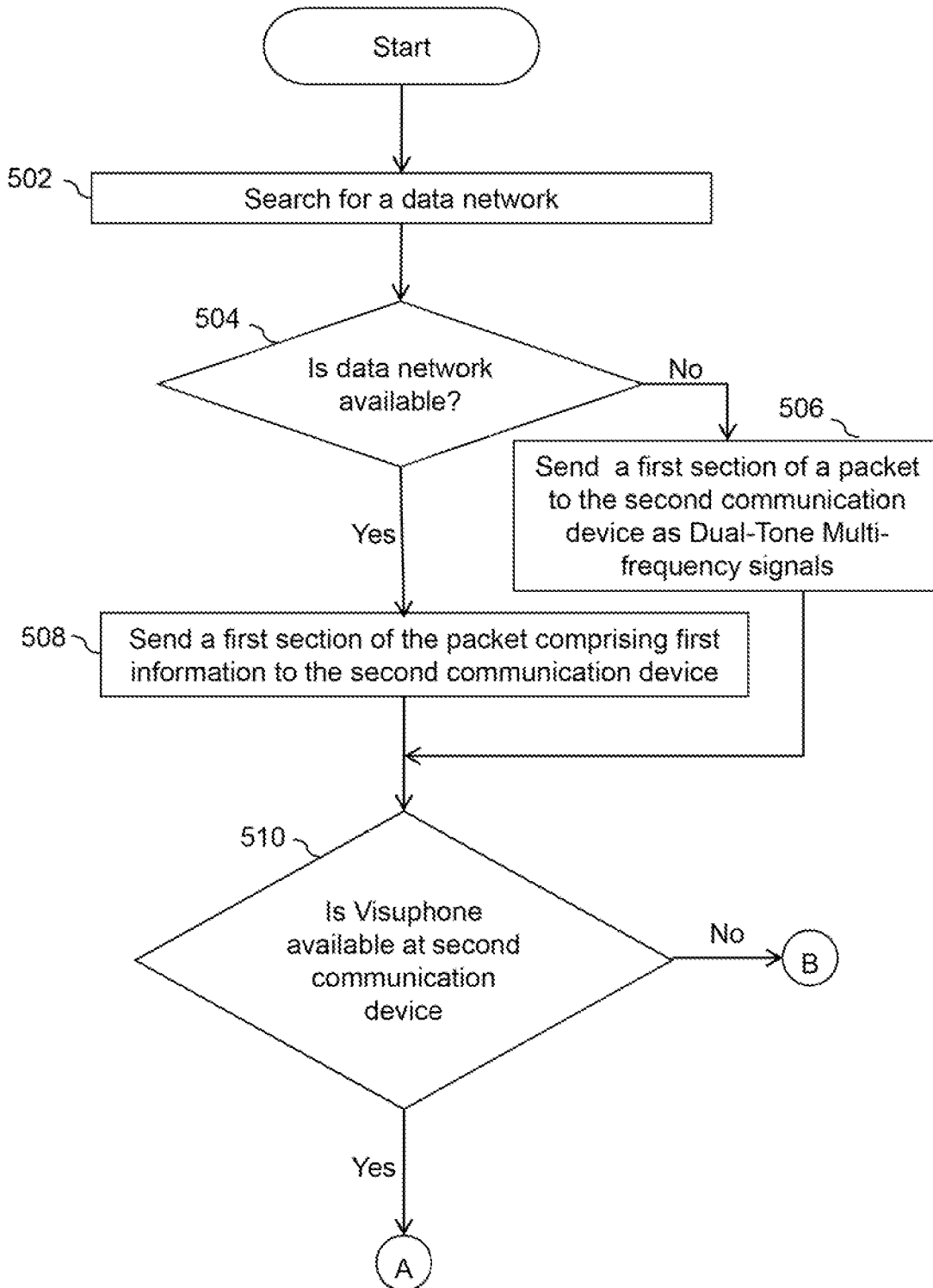

FIG. 5A

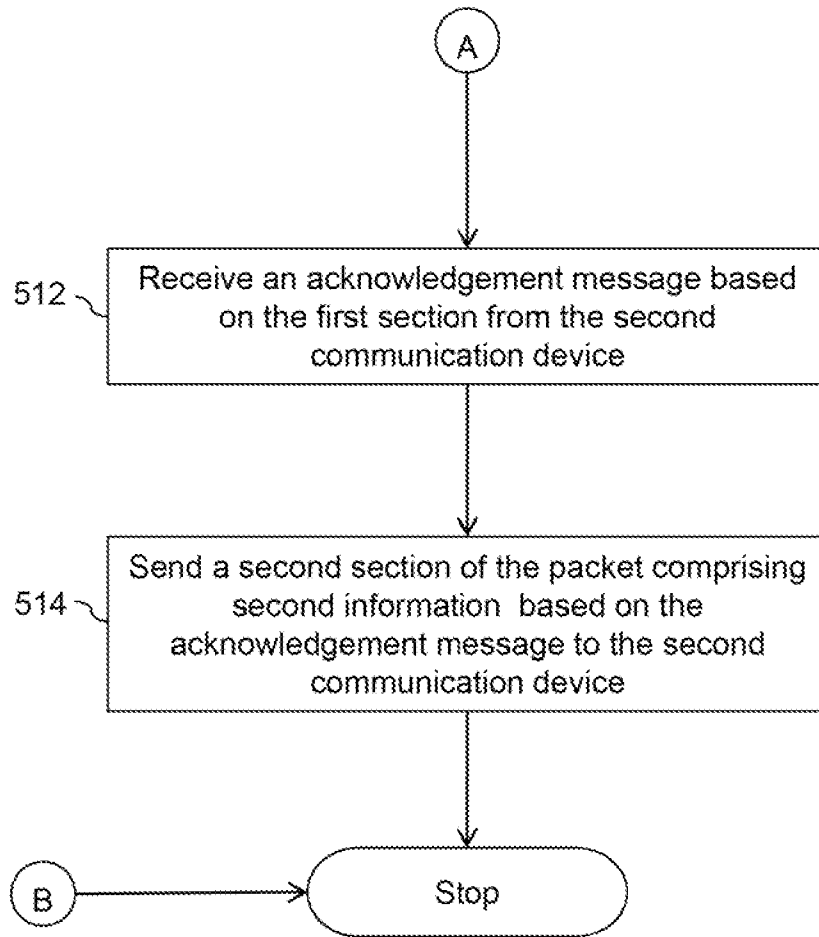

FIG. 5B

SYSTEMS AND METHODS FOR COMMUNICATING WITH AN INTERACTIVE VOICE RESPONSE SYSTEM

CROSS REFERENCE TO RELATED APPLICATIONS

This application is a Continuation application (CA) of U.S. Non-Provisional application Ser. No. 13/046,532 entitled 'Systems and methods for communicating with an interactive voice response system' and filed on Mar. 11, 2011.

FIELD OF THE INVENTION

The invention relates to Interactive Voice Response (IVR) system and more specifically the invention relates to establishing, a communication session among plurality of communication devices comprising an IVR application.

BACKGROUND OF THE INVENTION

Interactive Voice Response (IVR) technology is generally used to detect voice and key inputs from a caller. Various organizations such as banks, insurance companies, and other service providers use IVR technology to manage calls from their customers. Typically, IVR systems are used by organizations that have high call volumes. An objective for implementing the IVR systems is to provide the customers with a quick and good experience. Moreover, the cost of providing the services is reduced.

Generally, when the caller calls a destination, such as a bank, an automated audio menu is played. The audio IVR menu can contain instructions to provide instant services such as account balance inquiry when the destination is a bank. Further, audio menu can provide options for the caller to connect to a desired can inside the destination. For example, the menu may direct the caller to press various keys on a telephone to connect to a particular department or agent. The audio IVR menu is designed specific to a destination. Therefore, each destination or organization may have different IVR menus. Further, the IVR menu in an organization can be based on the type of departments, type of services, customer care executives or agents and so forth. For example, an IVR menu of a bank may include options related to the account details of the caller, while an IVR menu of a pizzeria may contain options to order or select a pizza.

Typically, the caller calling the destination may have to listen and follow instructions on the menu to get a desired response or a function performed. Therefore, the process can be time consuming. Moreover, in case the caller provides an incorrect input, the complete process may have to be repeated. Furthermore, the IVR menu for an organization may be updated or changed regularly. For example, extension numbers inside an organization may be changed and correspondingly, the extension numbers associated with the IVR menu may be updated. As a result, a frequent caller may not be able to reach a desired end by remembering a combination of numbers. Therefore, the caller may become frustrated with the IVR systems.

Some prior art try to address this problem by providing visual form of IVR. These prior arts display the IVR menu graphically on a caller device. U.S. Pat. No. 7,215,743 assigned to International Business Machines Corporation and a published U.S. patent application with Ser. No. 11/957,605, filed Dec. 17, 2007 and assigned to Motorola Inc, provides the IVR menu of the destination in a visual form to the caller. The caller can select the options from the IVR menu without

listening to the complete audio IVR menu. However, the IVR menu displayed on the caller device is stored on an IVR server at the destination end. As a result, the visual IVR menu is specific to the destination and only the IVR of the destination dialled is displayed. These techniques therefore, require each destination to set-up hardware, software and other facilities to be deployed for providing visual IVR servers.

Another existing technique as disclosed in U.S. Pat. No. 6,560,320 assigned to International Business Machines Corporation enables an operator of the IVR to send customized signals to the caller for generating and displaying graphical elements on the device of the caller. Thereafter, the caller can respond by selecting options through touch-screen interface of the device. Dual Tone Multi frequency (DTMF) signals of the IVR. However, this technique requires a specifically configured device to interpret the codes sent as Dual Tone Multi frequency (DTMF) signals for generating the graphics. Moreover, an operator is required to present the graphics to the caller. Furthermore, specialized software and hardware are required at the operator to design and generate DIME codes. Therefore, the technique faces various practical limitations.

Generally, the IVR menus of the organizations are in form of audible menu. Moreover, there are a large number of organizations that use IVR menus. Therefore, converting the audible menus to visual menus can be time consuming. An existing technique, as disclosed in U.S. Pat. No. 6,920,425 assigned to Nortel Networks Limited, discloses an automated script to convert the audible menu scripts to visual menu scripts. However, the audible menu scripts must be available in a particular format to enable the conversion. Furthermore, the audio menu scripts must be available or downloadable for the program to function. As a result, only the audio menu scripts that are available can be converted to visual menu scripts. Furthermore, the device of the caller must be designed or programmed to understand the visual menu scripts.

The effectiveness of providing the IVR in visual form is discussed in a technical paper titled, 'The Benefits of Augmenting Telephone Voice Menu Navigation with Visual Browsing and Search' by Min Yin et al. The paper discusses a setup where visual content of the IVR is sent from a service provider to a computer connected to a mobile phone. However, the technique discussed in the paper is limited to the visual content provided by the service provider's end, after the connection is established. Moreover, the providers are required to individually set up the hardware and services for providing visual content.

As discussed above the existing technologies have various limitations. Therefore, system and method are desired for communicating among IVR enabled communication devices.

SUMMARY

Embodiments of the present invention provide a communication device. The communication device comprises a processor. Further, the communication device comprises a memory coupled to the processor. The memory comprises a database comprising at least one visual Interactive Voice Response (IVR) menu associated with at least one IVR system. Further, the memory comprises instructions executable by the processor for sending a first section of a data packet to a second communication device. The first section comprising first information is sent based on a visual IVR menu associated with the second communication device. Further, the memory comprises instructions executable by the processor for receiving an acknowledgement message from the second communication device based on the first section of the data packet. Furthermore, the memory includes instructions

executable by the processor for sending a second section of the data packet to the second communication device based on the acknowledgement message. The second section comprises second information.

An aspect of the invention is to provide a communication device for communicating with a second communication device. The communication device includes an IVR application such as Visuphone. In an embodiment, the second communication device also includes the IVR application such as Visuphone.

Embodiments of the present invention provide a method for communicating among a plurality of communication devices. The method comprises sending, by a communication device, a first section of a data packet to a second communication device. The first section comprising first information is sent based on a visual Interactive Voice Response (IVR) menu associated with at least one IVR system. Further, the method comprises receiving, at the communication device, an acknowledgement message from the second communication device based on the first section of the data packet. Furthermore, the method comprises sending, by the communication device, a second section of the data packet to the second communication device based on the acknowledgement message. The second section comprises second information.

Embodiments of the invention provide a method for establishing a communication session in a communication network. The method comprises dialling, by a communication device, a phone number of a second communication device. The second communication device comprises an Interactive Voice Response (IVR) system. Further, the method comprises detecting, by the communication device, a data network. Furthermore, the method comprises sending by the communication device, a first section of a data packet to the dialled second communication device when the data network is detected. The first section comprises first information.

An aspect of the invention is to provide a method for establishing a communication session in a communication network. The communication session may be established between two or more IVR enabled devices.

Another aspect of the invention is to provide a method for establishing a communication session among a plurality of communication devices. The communication devices may or may not include Visuphone.

Yet another aspect of the invention is to provide a method for establishing a communication session among a plurality of communication devices. The communication session is established by sending one or more packets when a data network such as the Internet is available.

BRIEF DESCRIPTION OF THE DRAWINGS

Having thus described the invention in general terms, reference will now be made to the accompanying drawings, which are not necessarily drawn to scale, and wherein:

FIG. 1A illustrates an exemplary environment where various embodiments of the invention function;

FIG. 1B illustrates another exemplary environment where various embodiments of the invention function;

FIG. 1C illustrates another exemplary environment where various embodiments of the invention function;

FIG. 1D illustrates yet another exemplary environment where various embodiments of the invention function;

FIGS. 2A and 2B illustrates exemplary components of the communication device for implementing a Visuphone, in accordance with an embodiment of the invention;

FIG. 3 illustrates exemplary components of the communication device for implementing the Visuphone, in accordance with another embodiment of the invention;

FIG. 4A illustrates an exemplary packet sent from a communication device to a second communication device, in accordance with an embodiment of the invention;

FIG. 4B illustrates an exemplary structure of a first section of the packet, in accordance with an embodiment of the invention; and

FIGS. 5A and 5B illustrates a flowchart diagram for communicating among a plurality of communication devices, in accordance with an embodiment of the invention.

DETAILED DESCRIPTION OF THE INVENTION

Illustrative embodiments of the invention now will be described more fully hereinafter with reference to the accompanying drawings, in which some, but not all embodiments of the invention are shown. Indeed, the invention may be embodied in many different forms and should not be construed, as limited to the embodiments set forth herein; rather, these embodiments are provided, so that this disclosure will satisfy applicable legal requirements. Like numbers refer to like elements throughout.

FIG. 1A illustrates an exemplary environment where various embodiments of the invention function. A communication network **100** includes a communication device **102a**. In an embodiment, the communication network **100** may include different types of communication devices **102a-n**. In an embodiment, the communication device **102a** may be referred as a first communication device. Further, the communication network **100** includes a second communication device **108a**. A person skilled in art will appreciate, that the communication network **100** may also include a plurality of communication devices **102**. In an embodiment, the communication network **100** may include a plurality of second communication devices **108**. Examples of the communication network **100** include, but are not limited to, the Internet, PSTN, Local Area Network (LAN), Wide Area Network (WAN), Metropolitan Area Network (MAN), and so forth. In an embodiment, the communication network **100** can be a data network such as the Internet. The data network is a network capable of establishing data and voice communication among various communication devices. In an embodiment, the communication network **100** can be a telecommunication or telephone network capable of establishing only voice communication among various communication devices.

A user **106** may use the communication device **102a** to connect to the second communication device **108a** (hereafter the second communication device **108a** may be referred as second communication device **108** or interchangeably). The communication device **102a** can be a telecommunication device that can connect directly to a Public Switched Telephone Network (PSTN) **110**. A person skilled in the art will appreciate, that the communication device **102a** can also connect to a private telephone exchange. Examples of the communication device **102a** include, but are not limited to a telephone, a mobile phone, a smart phone or any other device capable of voice or data communication. The user **106** may dial a phone number associated with the second communication device **108a** for initiating a call for connecting to the second communication device **108a**. The communication device **102a** may have one or more associated phone numbers, which may be used by other devices for connecting to the communication device **102a**. Similarly, each of the plurality of the second communication device **108** may have

associated at least one phone number. In another embodiment, the communication device **102a** may include a plurality of visual Interactive Voice Response (IVR) menus corresponding to phone numbers of the plurality of second communication devices **108**. In an embodiment, the communication device **102a** may include an IVR application.

In an embodiment, the communication device **102a** may include the IVR application such as Visuphone **104a**. The Visuphone **104a** may be hardware, an application stored as software, a firmware on the communication device **102a**, or a combination thereof. The Visuphone **104a** may provide data regarding a phone number of the second communication device **108a** dialled by a user **106** of the communication device **102a**. For example, the data may include geographical information or services provided by the second communication device **102a-n**. The second communication device includes an IVR system. The IVR system allows a caller or the user **106** to interact automatically with the second communication device **108a**. When the user **106** dials a phone number and connects to the second communication device **108a**, an audible IVR menu may be played to the user **106**. The second communication device **108a** can have more than one IVR menus. The Visuphone **104a** may display a visual IVR menu on the communication device **102a** corresponding to the audible IVR menu associated with the phone number of the second communication device **108a** to be connected.

The second communication device **108a** can be a device capable of data/voice communication. Examples of the second communication device **108a** include, but are not limited to, a telephone, a computer, a laptop computer, a personal digital assistant (PDA), a mobile phone, and so forth. Various types of the second communication device **108a** that implement the audible IVR menu include, for example, banks, hotels, fast-food outlets, utility services providers, corporate offices, mobile phone service providers, hospitals and so forth. In an embodiment, the second communication device **108a** can have more than one audio/visual IVR menus. Typically, the audible IVR menu provided by the second communication device **108a** comprises audible options or instructions. In an embodiment, the visual IVR menu includes one or more text and/or graphical representation of different nodes corresponding to afferent nodes of the audio IVR menu. The user **106** may be required to select various options from the audible IVR menu to obtain the required information or service from the dialled second communication device.

In an embodiment, the Visuphone **104a** may send or receive, one or more messages to or from the second communication device **108a** for establishing a communication session with the second communication device **108a**. The one or more messages may be sent as data packets when a data network such as the Internet is available. In an embodiment, the one or more messages may be sent as Dual-Tone Multi-Frequency (DTMF) signals or tones. After establishing a communication session with the second communication device **108a**, the user **106** can interact with the second communication device **108a** via the visual IVR menu associated with the second communication device **108a**. In an embodiment, the communication device **102a** may receive an acknowledgement message from the second communication device **108a**.

In an embodiment, the communication network **100** may include a server. The server may maintain the updated information of the second communication device **108a**. In an embodiment of the invention, the communication device **102a** can request and/or receive updates from the server.

FIG. 1B illustrates another exemplary environment where various embodiments of the invention function. As discussed with reference to FIG. 1A, the communication network

includes the communication device **102a** and the second communication device **108a**. As shown the communication network **100** may further include, a second communication device **108b** (hereafter the second communication device **108b** may be referred as second communication device **108** or interchangeably). The communication device **102a** can be a telecommunication device that can connect directly to a PSTN **110**. The communication device **102a** includes a Visuphone **104a** capable of displaying data related to the second communication device **108a**. Further, the Visuphone **104a** may send or receive one or more messages to or from the second communication device **108a**. In an embodiment, the one or more messages exchanged may be in the form of data packets. In an embodiment, the data packet may be an Internet Protocol version 6 (IPv6) packet. In another embodiment, the one or more messages exchanged may be in the form of DTMF signals or tones.

In an embodiment of the invention, the second communication device **108b** may also include a Visuphone **104b**. The Visuphone **104b** may send or receive one or more messages including information such as acknowledgment to or from the communication device **102a**. The Visuphone **104b** is capable of sending messages required to establish a communication session with the communication device **102a**.

FIG. 1C illustrates another exemplary environment where various embodiments of the invention function. As shown, a communication device **102b** can be a communication device that may be connected directly to a network **114**. Examples of the communication device **102b** include, but are not limited to, a personal computer, a laptop, a mobile phone, a smartphone, a fixed line telephone, a Voice Over Internet Protocol (VOIP) phone or other devices capable of voice or data communication. The communication device **102b** may include various applications or computer programs that enable the user **106** to use the communication device **102b** for dialling a phone number of the second communication device **102a-n** through PSTN **110** over network **114** through a gateway **112**. For example, the applications may be VOW applications, such as but not limited to Skype, Magic Jack, Google Talk and so forth. Examples of the network **114** include any wired or wireless network, such as but not limited to, LAN, WAN, a Wi-Fi network and so forth. As discussed with reference to FIG. 1A and FIG. 1B, the second communication device **108b** (or **108a**) presents the audible IVR to the communication device **102b**. As discussed with reference to FIG. 1A, the Visuphone **104a** may initiate a call to a phone number of the second communication device **108b**. The Visuphone **104a** may further display the visual IVR menu associated with the dialled phone number of the second communication device **108b**. Further, the Visuphone **104a** may search or detect a data network. In an embodiment, the Visuphone **104a** may send one or more messages in the form of data packets when a data network such as the Internet is available to the second communication device **108b**. Further, the Visuphone **104a** may establish a communication session with the second communication device **108b** by exchanging one or more messages or data packets. Furthermore, the Visuphone **104a** may send a first section of a data packet including first information to the second communication device **108**. In an embodiment, the Visuphone **104a** may receive a message including acknowledgement information from the second communication device **108**. The communication device **102a** receives the acknowledgement message when the second communication device **108** (**108b**) includes an IVR application such as the Visuphone **104b** as shown in FIG. 113. The acknowledgement message may be received based on the first section of the data packet. Thereafter, the Visuphone **104a** of the commu-

nication device **102a** may send a second section of the data packet including second information such as a payload. In an embodiment, the first Visuphone **104** may exchange one or messages with the Visuphone **104b** or the second communication device **108a** in form of Dual-Tone Multi-Frequency (DTMF) signals or tones.

FIG. 1D illustrates yet another exemplary environment where various embodiments of the invention function. As shown, the communication device **102c** can be connected to the PSTN **110** through the network **114** or through a cellular network **116**. Various service providers provide multiple or overlapping services to customers. For example, cable television service provider may also provide phone and network service, optical network provider may also provide phone or television services, WiMax service providers that provide phone service, and so forth. The network **114** may be any service provider that provides such services, for example, but not limited to, cell phone services, wireless services, network services, cable television services, or various combinations of the above or other type of services. As discussed with reference to FIGS. 1A, 1B and 1C, the second communication device **108a** or **108b** includes one or more audible IVR menus. The communication device **102c** includes the Visuphone **104a** which displays data corresponding to the dialled phone number of the second communication device **108**. Further, the Visuphone **104a** may display a visual IVR menu corresponding to the audible IVR menu of the dialled phone number of the second communication device **108a** or **108b**. In an embodiment, the visual IVR menu may be displayed when a call is received from the second communication device **108b**. Thereafter, the user **106** may select one or more options from the displayed visual IVR menu. In an embodiment, the visual IVR menu may have an associated identity (ID) or number. The visual IVR menu will indicate the version information of the visual IVR menu. In an embodiment, the Visuphone **104a** may send selection information including one or more options selected by the user **106** to the second communication device **108b**. In an embodiment, the Visuphone **104a** may receive the audio/visual IVR menu from the second communication device **108b** when a latest version of the visual IVR menu is not available at the communication device **102c**. In an embodiment, the dialled second communication device **108b** may request the information from the server of the communication network **100** when the information requested by the Visuphone **104a** is not available at the second communication device **108b**. Thereafter, the second communication device **108b** may send the information received from the server to the Visuphone **104a**. The Visuphone **104a** may further request and/or receive information from the dialled second communication device **108b**. Further, the Visuphone **104a** may display the information at the communication device **102b**. In an embodiment, the Visuphone **104a** may include version information. The version information may be a combination of numbers, alphabets or an alphanumeric code indicating a version of the Visuphone **104a**.

FIGS. 2A and 2B illustrate exemplary components of the communication device **102a** for implementing the Visuphone **104a**, in accordance with an embodiment of the invention. The communication device **102a** includes a system bus **226** to connect the various components. Examples of system bus **226** include several types of bus structures including a memory bus, a peripheral bus, or a local bus using any of a variety of bus architectures. As discussed with reference to FIG. 1A, the communication device **102a** can be a communication device such as computer, a smart-phone, and so forth. The communication device **102a** can connect to PSTN **110** through a gateway **224**, which is connected to network **114** through a

network interface **212**. Input/Output (IO) interface **214** of the communication device **102a** may be configured to connect external or peripheral devices such as a memory card **216**, a keyboard **218**, a Universal Serial Bus (USB) device **220** and a mouse **222**. Although not shown, various other devices can be connected through IO interface **214** to the communication device **102a**. In an embodiment of the invention, the communication device **102a** may be connected to a hub that provides various services such as voice communication, network access, television services and so forth. For example, the hub may be a Home Gateway device that acts as a hub between the home environment and the Broadband Network.

The communication device **102a** includes a display **202** to output graphical information to the user **106**. In an embodiment of the invention, the display **202** may include a touch sensitive screen. Therefore, the user **106** can provide inputs to the communication device **102a** by touching display **202** or by point and click using the 'mouse'. A memory **206** of the communication device **102a** stores various programs, data and/or instructions that can be executed by a processor **204**. Examples of the memory **206** include, but are not limited to, a Random Access Memory (RAM), a Read Only Memory (ROM), a hard disk, and so forth. A person skilled in the art will appreciate that other types of computer-readable media which can store data that is accessible by a computer, such as magnetic cassettes, flash memory cards, digital video disks, and the like, may also be used by the communication device **102a**. The memory **206** may include Operating System (OS) (not shown) for the communication device **102a** to function. Further, the memory **206** may include other applications that enable the user **106** to communicate/interact with the second communication device **108a** (or **108b**). Examples of other applications include, but are not limited to, Skype, Google Talk, Magic Jack, and so forth. Other applications may be stored as software or firmware on the communication device **102a**.

Further, the memory **206** includes the Visuphone **104a** for providing a visual representation of the second communication device **108**. As discussed with reference to the FIG. 1A, the Visuphone **104a** may be hardware, a software or a firmware stored on the communication device **102a**. In an embodiment, the Visuphone **104a** may be implemented as plug-in to other applications. The visual IVR menus are stored in a database **208** in the memory **206** of the communication device **102a**. In an embodiment, the Visuphone **104a** may receive updates about the visual IVR menus from the server of the communication network **100** at predefined time. The predefined time may be for example, once a week, once a month, or any other interval predefined by the user **106** or the Visuphone **104a**. In an embodiment, the Visuphone **104a** of the communication device may initiate a communication session with a plurality of second communication devices **108**. In an embodiment, the Visuphone **104a** may send one or more messages for establishing a communication session to a plurality of second communication devices **108**.

In an embodiment, the Visuphone **104a** may display a visual IVR menu associated with the dialled phone number of the second communication device **108** before actual communication session establishment. In an embodiment, the Visuphone **104a** may display one or more communication options on the display **202** of the communication device **102a**. The user **106** may input one or more key or key combinations using the keyboard **218**. The keyboard **218** may be a physical keyboard or a virtual keyboard displayed on a touch screen display **202**. In an embodiment, the keyboard **218** is a keypad on the communication device **102a**. Subsequently, after some

processing by the Visuphone **104a**, the visual IVR menu corresponding to dialled phone number is searched and displayed on the display **202**.

In an embodiment of the invention, the visual IVR menu may be provided in real-time to the user **106**. In an embodiment of the invention, the visual IVR menu is provided by a messaging service such as a Short Messaging Service (SMS). Therefore, second communication device **108** may provide customized visual IVR menu to the user **106**. The visual IVR menu may be customized based on the profile of the user **106**. In an embodiment of the invention, the profile may be generated based on access pattern of user **106** or the data capture by a hub connected to the communication device **102a**.

The user **106** can interact with the visual IVR menu by pressing a desired button from the keyboard **218**. For example, the user **106** can press a '3' key from the keyboard **218** to select a node 3 in the visual IVR menu. Further, the user **106** can directly select the node 3 of the visual IVR menu from the display **202**, in ease of a touch sensitive screen. Depending on the complexity or size of first party devices, visual IVR menu may have various nodes. Moreover, display area of the display **202** may be limited or small. As a result, all the nodes of the visual IVR menu may not be displayed together on the display **202**. In such a case, the Visuphone **104a** is configured to allow the user **106** to navigate by scrolling horizontally and/or vertically to view nodes on the visual IVR menu **202**. Further, the Visuphone **104a** may detect the capability of the communication device **102a** before displaying the visual IVR menu. For example, in ease the communication device **102a** is a basic mobile phone with limited functionality of the display screen. Therefore, the Visuphone **104a** may display the visual IVR menu in form of a simple list. Similarly, a list may be displayed in case of fixed line or wired telephones. Moreover, in ease the communication device **102a** includes a high capability screen, such as but not limited, to an iPhone, then the visual IVR menu is displayed in form of graphics. In one embodiment, the Visuphone **104a** is configured to detect and present an application or computer program available on the communication device **102a**.

In an embodiment, the user **106** may dial a phone number from a VOIP application **228** on the communication device **102b**, as shown in FIG. 4B. The phone number may correspond to any of the plurality of second communication device **108** of the communication network **100**. In an embodiment, the user **106** selects a pre-stored phone number from the VOIP application **228**. In an embodiment, the Visuphone **104a** may include a VOW plug-in that monitors the incoming/outgoing calls to/from the VOIP application. Therefore, the VOIP plug-in may search each phone number of the dialled second communication device **102** in the database **208**. In ease, the calling phone number is found in the database **208** and is associated with an audible IVR, then the VOIP plug-in may display the visual IVR menu corresponding to the audible IVR menu of the dialled phone number of the second communication device **108b**. In an embodiment, when the database does not include a match for the dialled phone number of the second communication device **108b**, then the communication device **102a** may request and/or receive a visual IVR menu associated with the phone number from the second communication device **102b**.

FIG. 3 illustrates exemplary components of communication device **102b** for implementing Visuphone **104a**, in accordance with another embodiment of the invention. The communication device **102b** includes a system bus **326** to connect the various components. Examples of system bus **326** include several types of bus structures such as, but not limited to, a memory bus or memory controller, a peripheral bus, or a local

bus using any of a variety of bus architectures. As discussed with reference to FIG. 1B, the communication device **102b** can be a computing device such as, but not limited to, a personal computer, a laptop, a mobile phone, a smart-phone, and so forth. The communication device **102b** can connect to the network **114** through a network interface **310**. Further, the communication device **102b** can connect to PSTN **110** through gateway **324** and the network **112** through a network interface **310**. An Input/Output (IO) interface **312** of the communication device **102b** may be configured to connect external or peripheral devices such as a mouse **314**, a keyboard **316**, a speaker **318**, a camera **320**, and a microphone **322**. Although not shown, various other devices such as a hard disk, a Universal Serial Bus (USB) device or others can be connected through the IO interface **312** to the communication device **102b**. A person skilled in the art will appreciate that although not described, various other types of devices capable of voice and/or data communication can be connected to the communication device **102b**.

The communication device **102b** includes a display interface **302** to connect to a display **308**. The display interface **302** can be for example, a video adapter. The display **308** outputs graphical information to the user **106**. In an embodiment of the invention, the display **308** includes a touch sensitive screen. Therefore, the user **106** can provide inputs to the communication device **102b** by touching the display **308** or by pointing with the mouse and click. A memory **306** of the communication device **102b** stores various programs, data and/or instructions that can be executed by Central Processing Unit (CPU) or processor **304**. Examples of the memory **306** include, but are not limited to, a Random Access Memory (RAM), a Read Only Memory (ROM), a hard disk, and so forth. A person skilled in the art will appreciate that other types of computer-readable media which can store data that is accessible by a computer, such as magnetic cassettes, flash memory cards, digital video disks, and the like, may also be used by communication device **102b**. The memory **306** may include Operating System (OS) not shown) for the communication device **102b** to function. Further, the memory **306** may include other applications that enable the user **106** to communication with the second communication device **108a** (or **108b**). Examples of the other applications, but are not limited, to, Skype, Google Talk, Magic Jack, and so forth. Other applications may be stored as software or firmware on the communication device **102b**. Further, the memory **306** includes the Visuphone **104a** for searching and presenting a visual IVR menu corresponding to the audible IVR menu of a dialled phone number of the second communication device **108**, as discussed with reference to FIGS. 2A and 2B. The Visuphone **104a** may be an application stored as a software or firmware on the communication device **102b**. The visual IVR menus are stored in visual menu database **208** in the memory **306** of the communication device **102b**. The Visuphone **104a** searches the visual menu database **208** for a visual IVR menu corresponding to a phone number of the dialled phone number of the second communication device **108**. Subsequently, the visual IVR menu is presented on the display **308** for selection of options by the user **106** or caller. Further, the Visuphone **104** may be implemented as plug-in to the other applications. Therefore, when a phone number is dialled from the other applications, the Visuphone **104a** detects the dialling and automatically searches and displays the visual IVR menu corresponding to the dialled phone number. Thereafter, the user **106** can interact with the visual IVR menu, without listening to the audible IVR menu of the second communication device **108b**. In an embodiment, the second communication device **108b** may include a Visuphone **104b** as shown in

FIG. 1B. The Visuphone **104b** can function similar to the Visuphone **104a** as explained above.

FIG. 4A illustrates an exemplary packet **402** sent from the communication device **102** to the second communication device **108b**, in accordance with an embodiment of the present invention, in an embodiment, the Visuphone **104a** of the communication device **102a** may send the packet **402** to the second communication device **108b** for establishing a communication session when a data network such as the Internet is available. Examples of the packet **402** include but are not limited to an Internet Protocol version 4 (IPv4) packet, an Internet Protocol version 6 (IPv6) packet, and so forth. In an embodiment, the packet **402** includes a first section **402a** and a second section **402b**. The first section **402a** of the packet includes first information. In an embodiment, the first section **402a** may include header information. Examples of the first information include, but are not limited to Visuphone version, a visual menu identity (ID) of the visual IVR menu associated with the second communication device **108**, an ACK bit, and so forth. The Visuphone version indicates the version information of the Visuphone **104a** present at the communication device **102a**. The visual menu ID indicates the identity information of the visual IVR menu associated with the dialled phone number of the second communication device **108**. In an embodiment, the ACK or acknowledgement bit may be used by the second communication device to send an acknowledgement message. In an embodiment, the ACK bit may have a value such as 0 or 1. For example, the second communication device **108** may set the ACK bit or acknowledgement bit to 1 and send it back to the communication device **102a** as an acknowledgement message. A value 1 in the ACK bit indicates that the message is an acknowledgement message for a previously sent message or section of the packet. In an embodiment, the second communication device **108** sends the acknowledgement message when the second communication device **108** includes the Visuphone **104b**. The ACK bit set as indicated that the packet sent from the first section has been received at the second communication device **108**. In an embodiment of the invention, the first section **402a** may be a header section of IPv6 packet. The structure of header section or first section **402a** is shown in FIG. 4B.

In an embodiment, the second section **402b** of the packet **402** may include second information. Examples of the second information include, but are not limited to, a user ID, user options (selected from the visual IVR menu), user profile information (last dialled, details), and so forth. In an embodiment, the second section may include a data or payload section. The user ID is the identity information of the user **106** dialling the phone number of the second communication device **108**. The user options indicate selection information including the one or more options selected from the displayed visual IVR menu. The Visuphone **104a** displays the visual IVR menu associated with the second communication device **108** when the user dials the phone number of the second communication device **108**. The user profile indicates the information related to previous communication session or activities of the user **106** or communication device **102a**. The user profile indicates information such as last dialled numbers, time of last call, duration of last call to the second communication device **108**, access pattern of the user **106**, and so forth. In an embodiment, the second section **402b** may be a payload or data section of IPv6 packet. In an embodiment, the information of the first section **402a** and the second section **402b** may be sent separately as two different packets by the Visuphone **104a**. In an embodiment the first section **402a** and second section **402b** may be sent in form of DIME

tones or signals. The messages are sent in form of DTMF tones when the data network is not available.

FIG. 4B illustrates an exemplary structure of the first section **402a** of the packet **402**, in accordance with an embodiment of the invention. In an embodiment, the first section **402a** of the packet **402** may be a header section of IPv6 packet. The first section **402a** may include a plurality of fields. Example of plurality of fields include, but are not limited to, a packet version, a traffic class, a flow label, a payload length, a next header, a hop limit, a source address, a destination address, and so forth. The packet version indicates version information associated with the packet **402** such as IPv4, IPv6, and so forth. The version information may include numeric characters, alphabets or a combination thereof. In an embodiment of the invention, the traffic class may indicate whether the source device i.e. communication device **102a** of the packet **402** provides congestion control management or not. The flow label may be used to provide real time applications special services. The next header field points to next element or packet in the chain of packets when multiple packets are sent. The payload, length may indicate the size or length of the payload or data section (the second section **402b**). The hop limit may indicate the number of stops or hops the packet **402** may take before reaching the final destination or the second communication device **108**. The source address may include the address of the communication device **102a**. The destination address may be address of the second communication device **108**. In an embodiment, the destination address may be the address of next hop of the packet **402**.

FIGS. 5A and 5B illustrates a flowchart diagram for communicating among a plurality of communication devices, in accordance with an embodiment of the invention. As discussed with reference to the FIGS. 1A and 1B, the communication network **100** includes the communication device **102a**. Further, the communication network **100** includes the second communication device **108**. In an embodiment, the communication device **102a** may include the Visuphone **104a**. In an embodiment, the second communication device **108b** may include a Visuphone **104b** as shown in FIG. 1B. In another embodiment, the second communication device **108** may not include a Visuphone as shown in FIG. 1A. The Visuphone **104a** of the communication device **102a** may send one or more messages or packets to the second communication device **108**. The messages may be sent as Dual-Tone Multi-Frequency signals or tones depending on the availability of the data network. Similarly, the Visuphone **104b** may receive or send one or more messages/packets from/to the communication device **102**. Further, the Visuphone **104** may display the visual IVR menu associated with a phone number of the second communication device **108**. The communication device **102a** includes one or more visual IVR menus associated with a plurality of second communication devices.

The user **106** may dial a phone number of the second communication device **108**. In an embodiment, the Visuphone **104a** may display a visual IVR menu associated with the dialled second communication device **108**. At step **502**, the Visuphone **104a** of the communication device searches for a data network such as the Internet. At step **504**, an availability of the data network is checked. When the data network is available the process continues to step **508** else the process control goes to step **506**. At step **506**, the Visuphone **104a** sends a first section of the packet to the second communication device **108** such as the second communication device **108b** as DTMF signals or tones. The first section may include a first information or header information. Thereafter, the

communication device **102a** and the second communication device **108** may further communicate through the exchange of DTMF tones or signals.

At step **508**, the Visuphone **104a** sends a first section of the packet as a data packet to the second communication device **108a** when the data network is available. In an embodiment, the data packet may be an IPv4 packet, an IPv6 packet, and so forth. The first section **104a** includes first information. Examples of the first information include, but are not limited to, Visuphone version, a visual menu identity (ID) associated with the visual IVR menu corresponding to the second communication device **108**, an ACK bit, hop limit, payload length, traffic class, and so forth. The Visuphone version indicates the version information of the Visuphone **104a** present at the communication device **102a**. In an embodiment, the visual menu ID may indicate the identity information of the visual IVR menu associated with the dialled phone number of the second communication device **108**. The ACK bit or acknowledgement bit may be used by the second communication device to send an acknowledgement message from which the first section is received. In an embodiment, the ACK bit may have a value such as 0 or 1. At step **510**, it is checked, at the second communication device **108**, whether a Visuphone is available at the second communication device **108**. If the Visuphone is not available, the communication device **102** and the second communication device **108** may communicate by exchanging messages/information as DTMF tones or signals else process control goes to step **512**. At step **512**, an acknowledgement message based on the first section is received from the second communication device **108**. In an embodiment, the acknowledgement message is received based on the first information of the first section. In an embodiment, the Visuphone **104b** of the second communication device **108b** sends the acknowledgement message to the communication device **102a**.

At step **514**, the Visuphone **104a** sends a second section of the packet including second information to the second communication device **108b**. Examples of the second information include, but are not limited to, a user ID, user options (selected from the visual IVR menu), user profile information (last dialled details), and so forth. The user ID is the identity information of the user **106** who dials the phone number of the second communication device **108**. The user options indicate selection information including the one or more options selected from the displayed visual IVR menu. The visual IVR menu is associated with the phone number of the second communication device **108** dialled from the communication device **102a**. The Visuphone **104a** may display the visual IVR menu associated with the second communication device **108**. The user profile indicates the information related to previous communication session or activities of the user **106** or the communication device **102a**. The user profile indicates information such as last dialled numbers, time of last call, duration of last call to the second communication device **108**, and so forth.

In an embodiment, the Visuphone **104a** may send header information as a first section of the packet and data or payload as second section of the packet. In an embodiment, the communication device may send the second section of the packet after receiving an acknowledgement message from the second communication device. In an embodiment, the first section and the second section of the packet may be sent as a single packet **402**, as shown in FIG. **4**.

Embodiments of the invention provide a method for establishing a communication session among a plurality of communication devices. A communication device may send a first section including first information or header information to a

second communication device. A Visuphone at the communication device sends the first section. The communication device includes one or more visual IVR menus. The header information may include information such as Visuphone version, visual IVR menu ID, ACK bit, and so forth. In an embodiment, the communication device may receive an acknowledgement message based on the first section from the second communication device. The acknowledgement message is received when the second communication device includes a Visuphone. Thereafter, the Visuphone at the second communication device may send a second section or packet including a second information or payload to the second communication device. The payload may include information such as user ID, user profile, user selection, and so forth. Thereafter, a communication session is established between the communication device and the second communication device. In an embodiment, the second communication device may not include the Visuphone. In such a case the communication device and the second communication device communicates through DTMF signals or tones.

An advantage of the invention is that the communication device can send more information as data packets/messages to the second communication device by using a data network. The data packets may be exchanged among various communication devices. The data packet may include information required for establishing a communication session.

Another aspect of the invention is to provide a system for communicating among a plurality of IVR enabled communication devices.

Embodiments of the invention are described above with reference to block diagrams and schematic illustrations of methods and systems according to embodiments of the invention. It will be understood that each block of the diagrams and combinations of blocks in the diagrams can be implemented by computer program instructions. These computer program instructions may be loaded onto one or more general purpose computers, special purpose computers, or other programmable data processing translator to produce machines, such that the instructions which execute on the computers or other programmable data processing translator create means for implementing the functions specified in the block or blocks. Such computer program instructions may also be stored in a computer-readable memory that can direct a computer or other programmable data processing apparatus to function in a particular manner, such that the instructions stored in the computer-readable memory produce an article of manufacture including instruction means that implement the function specified in the block or blocks.

While the invention has been described in connection with what is presently considered to be the most practical and various embodiments, it is to be understood that the invention is not to be limited to the disclosed embodiments, but on the contrary, is intended to cover various modifications and equivalent arrangements included within the spirit and scope of the appended claims. The invention has been described in the general context of computing devices, phone and computer-executable instructions, such as program modules, being executed by a computer. Generally, program modules include routines, programs, characters, components, data structures, etc., that perform particular tasks or implement particular abstract data types. A person skilled in the art will appreciate that the invention may be practiced with other computer system configurations including hand-held devices, multiprocessor systems, microprocessor-based or programmable consumer electronics, network PCs, mini-computers, mainframe computers, and the like. Further, the invention may also be practiced in distributed computing

15

worlds where tasks are performed by remote processing devices that are linked through a communications network. In a distributed computing world, program modules may be located in both local and remote memory storage devices.

This written description uses examples to disclose the invention, including the best mode, and also to enable any person skilled in the art to practice the invention, including making and using any devices or systems and performing any incorporated methods. The patentable scope the invention is defined in the claims, and may include other examples that occur to those skilled in the art. Such other examples are intended to be within the scope of the claims if they have structural elements that do not differ from the literal language of the claims, or if they include equivalent structural elements with insubstantial differences from the literal languages of the claims.

The invention claimed is:

1. A user communication device for communicating in a network, wherein said user communication device, comprising:

a processor; and

a memory coupled to the processor, the memory comprising:

a database comprising at least one visual Interactive Voice Response (IVR) menu associated with at least one IVR system;

instructions executable by the processor for sending a first section of a data packet to a second communication device, wherein the first section comprising first information is sent based on a visual IVR menu associated with the second communication device;

instructions executable by the processor for receiving an acknowledgement message from the second communication device based on the first section of the data packet; and

instructions executable by the processor for sending a second section of the data packet to the second communication device based on the acknowledgement message, wherein the second section comprises second information.

2. The user communication device of claim 1, wherein the first information comprises at least one of:

a visual menu identity (ID) associated with a visual IVR menu of the second communication device, the visual IVR menu comprises one or more options; and version information of an IVR application associated with the user communication device.

3. The user communication device of claim 1, wherein said user communication device is a user mobile terminal with communication channel to said second communication and to a user device.

4. The user communication device of claim 1, wherein the memory further comprises:

instructions executable by the processor for transferring to be displayed the visual IVR menu associated with said second communication device.

5. The user communication device of claim 1, wherein the acknowledgement message is received when the second communication device comprises the IVR application.

6. A method for communicating among a first user communication device and a second user communication device comprising:

sending, by said first user communication device, a first section of a data packet to said second user communication device comprises an IVR system, wherein the first section comprising first information is sent based on a

16

visual Interactive Voice Response (IVR) menu associated with the second user communication device;

detecting, at said first user communication device, an acknowledgement message from the second user communication device based on the first section of the data packet; and

sending, by said first user communication device, a second section of the data packet to the second user communication device based on the acknowledgement message, wherein the second section comprises second information.

7. The method of claim 6, wherein the first information comprises at least one of:

a visual menu identity (ID) associated with a visual IVR menu of the second user communication device, the visual IVR menu comprises one or more options; and version information of an IVR application associated with the first user communication device.

8. The method of claim 6, wherein said first user communication device is a user mobile terminal with communication channel to said second user communication device and to a user device.

9. The method of claim 6 further comprising:

transferring to be displayed, at the first user communication device, a visual IVR menu associated with the second user communication device.

10. The method of claim 6, wherein the acknowledgement message is received when the second user communication device comprises an IVR application.

11. A computer readable media comprising instructions to implement the method of claim 6.

12. The method of claim 6 further comprising sending, by the first user communication device, one or messages as Dual-Tone Multi-Frequency (DTMF) signals to the second user communication device.

13. A method for establishing a communication session in a communication network between a first user communication device and a second user communication device, wherein said second user communication device comprises an Interactive Voice Response (IVR) system;

detecting, by said first user communication device, a data network;

sending, by said first user communication device, a first section of a data packet to the second user communication device when the data network is detected, wherein the first section comprises first information;

detecting, at said first user communication device, an acknowledgement message from the second user communication device based on the first section of the data packet; and

sending, by said first user communication device, a second section of the data packet to the second user communication device based on the acknowledgement message, wherein the second section comprises second information.

14. The method of claim 13 further comprising receiving, at the first user communication device, an acknowledgement message from the second user communication device based on the first section of the data packet, wherein the acknowledgement message is received when the second user communication device comprises an IVR application.

15. The method of claim 13 wherein said first user communication device is a user mobile terminal.

16. The method of claim 13, wherein the first information comprises at least one of:

a visual menu identity (ID) associated with a visual IVR menu of the second user communication device, the

visual IVR menu comprises one or more options; and version information of an IVR application associated with the first user communication device.

17. The method of claim 16, wherein said communication session is part of construction at least one visual menu record. 5

18. The method of claim 13 further comprising:

transferring to be displayed, at a user device, a visual IVR menu corresponding to the second user communication device, the visual IVR menu comprises one or more options. 10

19. The method of claim 13, wherein the first section is sent as Dual-Tone Multi-Frequency (DTMF) signals when the data network is not detected.

20. The method of claim 13, wherein the first user communication device comprises an IVR application. 15

* * * * *