



US008345835B1

(12) **United States Patent**
Or-Bach et al.

(10) **Patent No.:** **US 8,345,835 B1**
(45) **Date of Patent:** ***Jan. 1, 2013**

(54) **SYSTEMS AND METHODS FOR VISUAL PRESENTATION AND SELECTION OF IVR MENU**

5,006,987 A 4/1991 Harless
5,007,429 A 4/1991 Treatch et al.
5,027,400 A 6/1991 Baji et al.
5,086,385 A 2/1992 Launey et al.
5,144,548 A 9/1992 Salandro
5,265,014 A 11/1993 Haddock et al.
5,294,229 A 3/1994 Hartzell et al.
5,335,276 A 8/1994 Thompson et al.
5,416,831 A 5/1995 Chewning, III et al.
5,417,575 A 5/1995 McTaggart

(76) Inventors: **Zvi Or-Bach**, San Jose, CA (US); **Tal Lavian**, Sunnyvale, CA (US)

(*) Notice: Subject to any disclaimer, the term of this patent is extended or adjusted under 35 U.S.C. 154(b) by 0 days.

This patent is subject to a terminal disclaimer.

(Continued)

FOREIGN PATENT DOCUMENTS

EP 1001597 A2 5/2000

(Continued)

(21) Appl. No.: **13/245,212**

(22) Filed: **Sep. 26, 2011**

Related U.S. Application Data

(63) Continuation of application No. 13/186,984, filed on Jul. 20, 2011.

(51) **Int. Cl.**
H04M 1/64 (2006.01)
G06Q 30/00 (2012.01)

(52) **U.S. Cl.** **379/88.23**; 379/88.13; 379/88.18; 379/93.01; 379/93.23; 379/114.13; 434/219; 455/414.1; 455/445; 705/14.66; 705/26.62; 705/40; 705/50; 705/311

(58) **Field of Classification Search** 379/88.13, 379/88.18, 88.23, 114.13, 93.01, 93.23; 705/14.44, 705/14.54, 14.66, 40, 43, 50, 311, 26.62; 434/219; 455/414.1, 445

See application file for complete search history.

(56) **References Cited**

U.S. PATENT DOCUMENTS

4,048,728 A * 9/1977 Nason et al. 434/219
4,653,045 A 3/1987 Stanley et al.
4,736,405 A 4/1988 Akiyama
4,897,866 A 1/1990 Majmudar et al.

OTHER PUBLICATIONS

Yin, M., et al., "The Benefits of Augmenting Telephone Voice Menu Navigation with Visual Browsing and Search," CHI 2006 Proceedings, Managing Voice Input, Montreal, Quebec, Apr. 22-27, 2006, pp. 319-328.

(Continued)

Primary Examiner — Gerald Gauthier
(74) *Attorney, Agent, or Firm* — Venable LLP; Michael A. Sartori; Steven J. Schwarz

(57) **ABSTRACT**

Embodiments of the invention provide a system for generating an Interactive Voice Response (IVR) database, the system comprising a processor and a memory coupled to the processor. The memory comprising a list of telephone numbers associated with one or more destinations implementing IVR menus, wherein the one or more destinations are grouped based on a plurality of categories of the IVR menus. Further the memory includes instructions executable by said processor for automatically communicating with the one of more destinations, and receiving at least one customization record from said at least one destination to store in the IVR database.

20 Claims, 92 Drawing Sheets

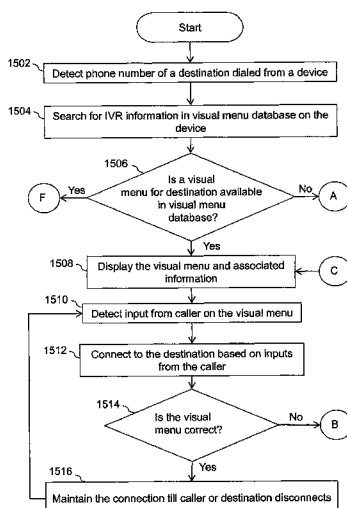

U.S. PATENT DOCUMENTS					
5,422,809 A	6/1995	Griffin et al.	6,405,033 B1	6/2002	Kennedy, III et al.
5,465,213 A	11/1995	Ross	6,408,301 B1	6/2002	Patton et al.
5,465,401 A	11/1995	Thompson	6,427,063 B1	7/2002	Cook et al.
5,475,399 A	12/1995	Borsuk	6,445,694 B1	9/2002	Swartz
5,499,330 A	3/1996	Lucas et al.	6,449,595 B1	9/2002	Arslan et al.
5,519,809 A	5/1996	Husseiny et al.	6,456,706 B1	9/2002	Blood et al.
5,533,102 A	7/1996	Robinson et al.	6,460,057 B1	10/2002	Butler et al.
5,550,746 A	8/1996	Jacobs	6,463,145 B1	10/2002	O'Neal et al.
5,572,581 A	11/1996	Sattar et al.	6,482,156 B2	11/2002	Iliff
5,576,951 A *	11/1996	Lockwood 705/26.62	6,505,146 B1	1/2003	Blackmer
5,585,858 A	12/1996	Harper et al.	6,510,411 B1	1/2003	Norton et al.
5,586,235 A	12/1996	Kauffman	6,529,500 B1	3/2003	Pandharipande
5,588,044 A	12/1996	Lofgren et al.	6,560,320 B1	5/2003	Paleiov et al.
5,592,538 A	1/1997	Kosowsky et al.	6,594,484 B1	7/2003	Hitchings, Jr.
5,606,361 A	2/1997	Davidsohn et al.	6,603,840 B2	8/2003	Fellingham et al.
5,633,909 A	5/1997	Fitch	6,606,374 B1	8/2003	Rokoff et al.
5,633,916 A	5/1997	Goldhagen et al.	6,606,611 B1	8/2003	Khan
5,657,221 A	8/1997	Warman et al.	6,606,741 B2	8/2003	Kojima et al.
5,689,648 A	11/1997	Diaz et al.	6,636,835 B2	10/2003	Ragsdale-Elliott et al.
5,708,422 A	1/1998	Blonder et al.	6,653,930 B1	11/2003	Bonomo et al.
5,724,412 A	3/1998	Srinivasan	6,658,389 B1	12/2003	Alpdemir
5,737,393 A	4/1998	Wolf	6,681,252 B1	1/2004	Schuster et al.
5,739,814 A	4/1998	Ohara et al.	6,705,869 B2	3/2004	Schwartz
5,740,549 A	4/1998	Reilly et al.	6,714,519 B2	3/2004	Luzzatti et al.
5,768,142 A	6/1998	Jacobs	6,731,625 B1	5/2004	Eastep et al.
5,790,652 A	8/1998	Gulley et al.	6,754,181 B1	6/2004	Elliott et al.
5,794,205 A	8/1998	Walters et al.	6,763,091 B2	7/2004	Shimada
5,796,806 A	8/1998	Birckbichler	6,788,770 B1	9/2004	Cook et al.
5,802,283 A	9/1998	Grady et al.	6,791,583 B2	9/2004	Tang et al.
5,802,526 A	9/1998	Fawcett et al.	6,816,580 B2	11/2004	Timmins
5,807,336 A	9/1998	Russo et al.	6,820,037 B2	11/2004	Simon
5,819,225 A	10/1998	Eastwood et al.	6,820,062 B1	11/2004	Gupta et al.
5,822,404 A	10/1998	Cave	6,826,194 B1	11/2004	Vered et al.
5,822,405 A	10/1998	Astarabadi	6,829,368 B2	12/2004	Meyer et al.
5,838,682 A	11/1998	Dekelbaum et al.	6,836,762 B2	12/2004	Speicher
5,838,775 A	11/1998	Montalbano	6,856,673 B1 *	2/2005	Banks et al. 379/114.13
5,867,816 A	2/1999	Nussbaum	6,862,713 B1	3/2005	Kraft et al.
5,873,068 A	2/1999	Beaumont et al.	6,865,268 B1	3/2005	Matthews et al.
5,885,083 A	3/1999	Ferrell	6,885,737 B1	4/2005	Gao et al.
5,885,245 A	3/1999	Lynch et al.	6,889,195 B2	5/2005	Strandberg
5,890,123 A	3/1999	Brown et al.	6,920,205 B2	7/2005	Hahn et al.
5,892,813 A	4/1999	Morin et al.	6,920,425 B1	7/2005	Will et al.
5,907,793 A	5/1999	Reams	6,920,431 B2	7/2005	Showghi et al.
5,912,952 A	6/1999	Brendzel	6,937,705 B1	8/2005	Godfrey et al.
5,913,195 A	6/1999	Weeren et al.	6,968,506 B2	11/2005	Yacovone et al.
5,920,477 A	7/1999	Hoffberg et al.	6,990,455 B2	1/2006	Vozick et al.
5,937,040 A *	8/1999	Wrede et al. 379/93.23	7,020,609 B2	3/2006	Thrift et al.
5,940,488 A	8/1999	DeGrazia et al.	7,027,571 B1	4/2006	Cook
5,948,040 A	9/1999	DeLorme et al.	7,027,990 B2	4/2006	Sussman
5,956,034 A	9/1999	Sachs et al.	7,036,128 B1	4/2006	Julia et al.
5,982,875 A	11/1999	Lieben et al.	7,039,589 B2	5/2006	Whitham
5,987,103 A	11/1999	Martino	7,047,196 B2	5/2006	Calderone et al.
6,009,398 A	12/1999	Mueller et al.	7,065,188 B1	6/2006	Mei et al.
6,014,428 A	1/2000	Wolf	7,068,643 B1	6/2006	Hammond
6,020,915 A	2/2000	Bruno et al.	7,092,738 B2	8/2006	Creamer et al.
6,049,779 A	4/2000	Berkson	7,100,118 B1	8/2006	Klask
6,055,513 A	4/2000	Katz et al.	7,130,391 B2	10/2006	Janakiraman et al.
6,062,863 A	5/2000	Kirksey et al.	7,130,800 B1	10/2006	Currey et al.
6,088,429 A	7/2000	Garcia	7,136,480 B2	11/2006	Mason
6,088,712 A	7/2000	Huang et al.	7,139,591 B2	11/2006	Callaghan et al.
6,091,805 A	7/2000	Watson	7,145,898 B1	12/2006	Elliott
6,091,956 A	7/2000	Hollenberg	7,145,902 B2	12/2006	Schindler et al.
6,104,790 A	8/2000	Narayanaswami	7,146,321 B2	12/2006	Cyr et al.
6,144,848 A	11/2000	Walsh et al.	7,149,549 B1	12/2006	Ortiz et al.
6,148,065 A	11/2000	Katz	7,159,008 B1	1/2007	Wies et al.
6,169,734 B1	1/2001	Wilson	7,177,814 B2	2/2007	Gong et al.
6,212,547 B1	4/2001	Ludwig et al.	7,180,889 B1	2/2007	Kung et al.
6,228,921 B1	5/2001	Kasemann et al.	7,180,985 B2	2/2007	Colson et al.
6,229,694 B1	5/2001	Kono	7,181,401 B2	2/2007	Johnson et al.
6,230,197 B1	5/2001	Beck et al.	7,181,502 B2	2/2007	Incertis
6,259,444 B1	7/2001	Palmer et al.	7,188,352 B2	3/2007	Nathan et al.
6,263,064 B1	7/2001	O'Neal et al.	7,203,517 B2	4/2007	Shimoda et al.
6,273,726 B1	8/2001	Kirksey et al.	7,206,745 B2	4/2007	Sarukkai et al.
6,321,198 B1	11/2001	Hank et al.	7,206,809 B2	4/2007	Ludwig et al.
6,335,678 B1	1/2002	Heutschi	7,209,124 B2	4/2007	Hunt et al.
6,366,650 B1	4/2002	Rhie et al.	7,213,061 B1	5/2007	Hite et al.
6,373,817 B1	4/2002	Kung et al.	7,215,743 B2	5/2007	Creamer et al.
6,400,807 B1	6/2002	Hewitt et al.	7,216,348 B1	5/2007	deCarmo
			7,225,409 B1	5/2007	Schnarel et al.

7,225,455 B2	5/2007	Bennington et al.	2004/0198316 A1	10/2004	Johnson	
7,228,492 B1	6/2007	Graham	2004/0204116 A1	10/2004	Ben-Efraim et al.	
7,231,636 B1	6/2007	Evans	2004/0217986 A1	11/2004	Hambleton et al.	
7,231,656 B1	6/2007	Nathan	2005/0004977 A1	1/2005	Roberts et al.	
7,240,006 B1	7/2007	Brocius et al.	2005/0055310 A1*	3/2005	Drewett et al.	705/50
7,240,289 B2	7/2007	Naughton et al.	2006/0165050 A1	7/2006	Erhart et al.	
7,246,063 B2	7/2007	James et al.	2006/0203977 A1	9/2006	Erhart et al.	
7,248,885 B2	7/2007	Benco et al.	2006/0239422 A1	10/2006	Rinaldo et al.	
7,250,939 B2	7/2007	Lira	2006/0259424 A1*	11/2006	Turcotte et al.	705/40
7,254,227 B2	8/2007	Mumick et al.	2006/0262921 A1	11/2006	Eppel et al.	
7,265,861 B1	9/2007	Ranalli et al.	2006/0277043 A1	12/2006	Tomes et al.	
7,266,185 B2	9/2007	Trandal et al.	2006/0285662 A1	12/2006	Yin et al.	
7,266,186 B1	9/2007	Henderson	2007/0026852 A1	2/2007	Logan et al.	
7,266,499 B2	9/2007	Surace et al.	2007/0032247 A1	2/2007	Shaffer et al.	
7,272,222 B2	9/2007	Joseph et al.	2007/0038513 A1*	2/2007	Flax et al.	705/14
7,272,497 B2	9/2007	Koshiji et al.	2007/0094109 A1	4/2007	Perry	
7,277,854 B2	10/2007	Bennett et al.	2007/0123223 A1*	5/2007	Letourneau et al.	455/414.1
7,280,097 B2	10/2007	Chen et al.	2007/0223662 A1	9/2007	Jain et al.	
7,280,646 B2	10/2007	Urban et al.	2007/0239537 A1*	10/2007	Protheroe et al.	705/14
7,280,651 B2	10/2007	Anderson	2007/0243887 A1	10/2007	Bandhole et al.	
7,286,990 B1	10/2007	Edmonds et al.	2007/0298776 A1	12/2007	Arlene	
7,289,608 B2	10/2007	Kumhyr	2008/0066015 A1	3/2008	Blankenhorn	
7,289,904 B2	10/2007	Uyeki	2008/0095330 A1	4/2008	Jin et al.	
7,299,405 B1	11/2007	Lee et al.	2008/0098353 A1	4/2008	Hambleton et al.	
7,303,121 B2	12/2007	Martinez	2008/0226042 A1	9/2008	Singh	
7,319,477 B2	1/2008	Katz	2008/0250334 A1	10/2008	Price	
7,324,633 B2	1/2008	Gao et al.	2009/0041215 A1	2/2009	Schmitt et al.	
7,324,947 B2	1/2008	Jordan et al.	2009/0116414 A1	5/2009	Or et al.	
7,328,239 B1	2/2008	Berberian et al.	2009/0136014 A1	5/2009	Bigue et al.	
7,330,890 B1	2/2008	Partovi et al.	2009/0154666 A1	6/2009	Rios et al.	
7,331,036 B1	2/2008	Hambleton et al.	2009/0202050 A1	8/2009	Berger et al.	
7,353,016 B2	4/2008	Roundtree et al.	2009/0207980 A1	8/2009	Berger et al.	
7,366,287 B2	4/2008	Stroud et al.	2009/0207996 A1	8/2009	Berger et al.	
7,392,193 B2	6/2008	Mault	2009/0225788 A1	9/2009	Kephart et al.	
7,398,215 B2	7/2008	Mesbah et al.	2009/0228908 A1	9/2009	Margis et al.	
7,406,413 B2	7/2008	Geppert et al.	2009/0245487 A1*	10/2009	Jockusch	379/93.01
7,412,533 B1	8/2008	Johnson et al.	2009/0276441 A1	11/2009	Malik	
7,421,724 B2	9/2008	Klosterman et al.	2009/0276708 A1	11/2009	Smith et al.	
7,433,452 B2	10/2008	Taylor et al.	2009/0280863 A1	11/2009	Shin et al.	
7,440,898 B1	10/2008	Eberle et al.	2009/0285380 A1	11/2009	Chen et al.	
7,450,112 B2	11/2008	Shneidman	2010/0007028 A1	1/2010	Fachmann et al.	
7,460,652 B2	12/2008	Chang	2010/0021030 A1	1/2010	Collins et al.	
7,466,803 B2	12/2008	Burg et al.	2010/0049654 A1*	2/2010	Pilo	705/43
7,492,883 B2	2/2009	Kumhyr	2010/0087175 A1	4/2010	Roundtree	
7,515,695 B1	4/2009	Chan et al.	2010/0100377 A1	4/2010	Madhavapeddi et al.	
7,539,484 B2	5/2009	Roundtree	2010/0166158 A1	7/2010	Costello et al.	
7,546,143 B2	6/2009	Nelson et al.	2010/0172481 A1	7/2010	Canu et al.	
7,584,249 B2	9/2009	Mumick et al.	2010/0189250 A1	7/2010	Williams et al.	
7,606,741 B2	10/2009	King et al.	2011/0009096 A1	1/2011	Rotsztein et al.	
7,646,858 B2	1/2010	Salafia et al.	2011/0014952 A1	1/2011	Minton	
7,693,720 B2	4/2010	Kennewick et al.	2011/0060683 A1	3/2011	Salmon Rock et al.	
7,716,055 B1	5/2010	McIntosh et al.	2011/0091021 A1	4/2011	Adkar et al.	
7,720,091 B2	5/2010	Faber et al.	2011/0099116 A1*	4/2011	Gabel	705/311
7,729,490 B2	6/2010	Hemm et al.	2011/0276408 A1*	11/2011	Toole	705/14.66
7,757,173 B2	7/2010	Beaman	2012/0063574 A1*	3/2012	Or-Bach et al.	379/88.23
7,809,376 B2*	10/2010	Letourneau et al.				455/445
7,813,485 B2	10/2010	Yin et al.				
7,843,899 B2	11/2010	Burritt				
7,864,944 B2	1/2011	Khoury et al.	EP	1001597 A3	5/2000	
7,908,381 B2	3/2011	Koch et al.	EP	1120954 A2	8/2001	
7,966,188 B2	6/2011	Ativanichayaphong et al.	EP	1120954 A3	8/2001	
8,000,454 B1*	8/2011	Or-Bach et al.	EP	1225754 A2	7/2002	
8,023,624 B2	9/2011	Kargman et al.	EP	1225754 A3	7/2002	
8,054,952 B1*	11/2011	Or-Bach et al.	EP	1351477 A1	10/2003	
8,155,280 B1*	4/2012	Or-Bach et al.	EP	1545101 A2	6/2005	
8,160,215 B2*	4/2012	Or-Bach et al.	EP	1545101 A3	6/2005	
8,223,931 B1*	7/2012	Lavian et al.	EP	774853 B1	5/2006	
2002/0001371 A1	1/2002	Goldberg et al.	EP	1874018 A1	1/2008	
2002/0055844 A1	5/2002	L'Esperance et al.	JP	8-242307 A	9/1996	
2002/0059138 A1	5/2002	Priest et al.	JP	2004274425 A	9/2004	
2002/0147986 A1	10/2002	Michael et al.	WO	WO-9819259 A1	5/1998	
2003/0005126 A1	1/2003	Schwartz et al.	WO	WO-9820409 A8	5/1998	
2003/0007625 A1	1/2003	Pines et al.	WO	WO-9840826 A3	9/1998	
2003/0033382 A1	2/2003	Bogolea et al.	WO	WO-9848551 A3	10/1998	
2003/0039341 A1	2/2003	Burg et al.	WO	WO-9856158 A3	12/1998	
2003/0074198 A1	4/2003	Sussman	WO	WO-0131497 A1	5/2001	
2003/0112931 A1	6/2003	Brown et al.	WO	WO-0157851 A1	8/2001	
2004/0034561 A1*	2/2004	Smith	WO	WO-0165871 A1	9/2001	
2004/0122941 A1	6/2004	Creamer et al.	WO	WO-0217604 A1	2/2002	
			WO	WO-2004049306 A1	6/2004	

FOREIGN PATENT DOCUMENTS

WO	WO-2004064299	A3	7/2004
WO	WO-2007012831	A1	2/2007
WO	WO-2007081929	A2	7/2007
WO	WO-2007081929	A3	7/2007
WO	WO-2008086320	A1	7/2008
WO	WO-2009006173	A2	1/2009
WO	WO-2009006173	A3	1/2009
WO	WO-2009100477	A1	8/2009

OTHER PUBLICATIONS

Damhuis, M., et al., "A Multimodal Consumer Information Server with IVR Menu," 2nd IEEE Workshop on Interactive Voice Technology for Telecommunications Applications (IVTTA94), Kyoto, Japan, Sep. 25-27, 1994, pp. 73-76.

Trihandoyo, A., et al., "A real-time speech recognition architecture for a multi-channel interactive voice response system," International Conference on Acoustics, Speech, and Signal Processing, vol. 4, 1995, pp. 2687-2690.

Shah, S.A.A., et al., "Interactive Voice response with Pattern Recognition Based on Artificial Neural Network Approach," International Conference on Emerging Technologies, (ICET 2007), Nov. 12-13, 2007, pp. 249-252.

Hattori, S., et al., "A multimedia intelligent message communication system for distributed coordination environments," Electronics & Communications in Japan, Part I—Communications, vol. 76, No. 1, pp. 11-23 (1993).

Kalva, H., et al., "Delivering Object-Based Audio-Visual Services," IEEE Transactions on Consumer Electronics, vol. 45, No. 4, pp. 1108-1111, (1999).

Schmandt, "Phoneshell: the telephone as computer terminal," Proceedings of first ACM International Conference on Multimedia, Anaheim, CA, US, pp. 373-381, (1993).

Himberg, J., et al., "Time Series Segmentation for Context Recognition in Mobile Devices", IEEE, 203-210, (2001).

Schmandt, C., et al., "Phonetool: Integrating Telephones and Workstations," IEEE Communication Society, Nov. 27-30, pp. 0970-0974, (1989).

Basinger, R. G., et al., "Calling Card Service—Overall Description and Operational Characteristics", The Bell System Technical Journal, (1982).

Cadiz et al. "Designing and Deploying an Information Awareness interface" CSCW'02, Nov. 2002, ACM, pp. 314-323.

Corcoran et al. disclose "User interface technologies for home appliances and networks", IEEE Trans. Consumer Elect.; pp. 679-685, (1998).

Friedrich, "Graphical-User-Interface Module Eases Integration," Wireless Systems Design, Oct. 2004, 1 page.

Steul, D., "Redefining the Call Center: Customer Service on the Internet", Alcatel telecommunications Review, Alcatel, Paris Cedex, FR, 6, (Mar. 2000).

Balachandran, R., et al., "Dialog System for Mixed Initiative One-Turn Address entry and Error Recovery," Proceedings of SIGDIAL 2009, the 10th Annual Meeting of the Special Interest Group in Discourse and Dialogue, pp. 152-155, Queen Mary University of London, Association of Computational Logistics, (2009).

* cited by examiner

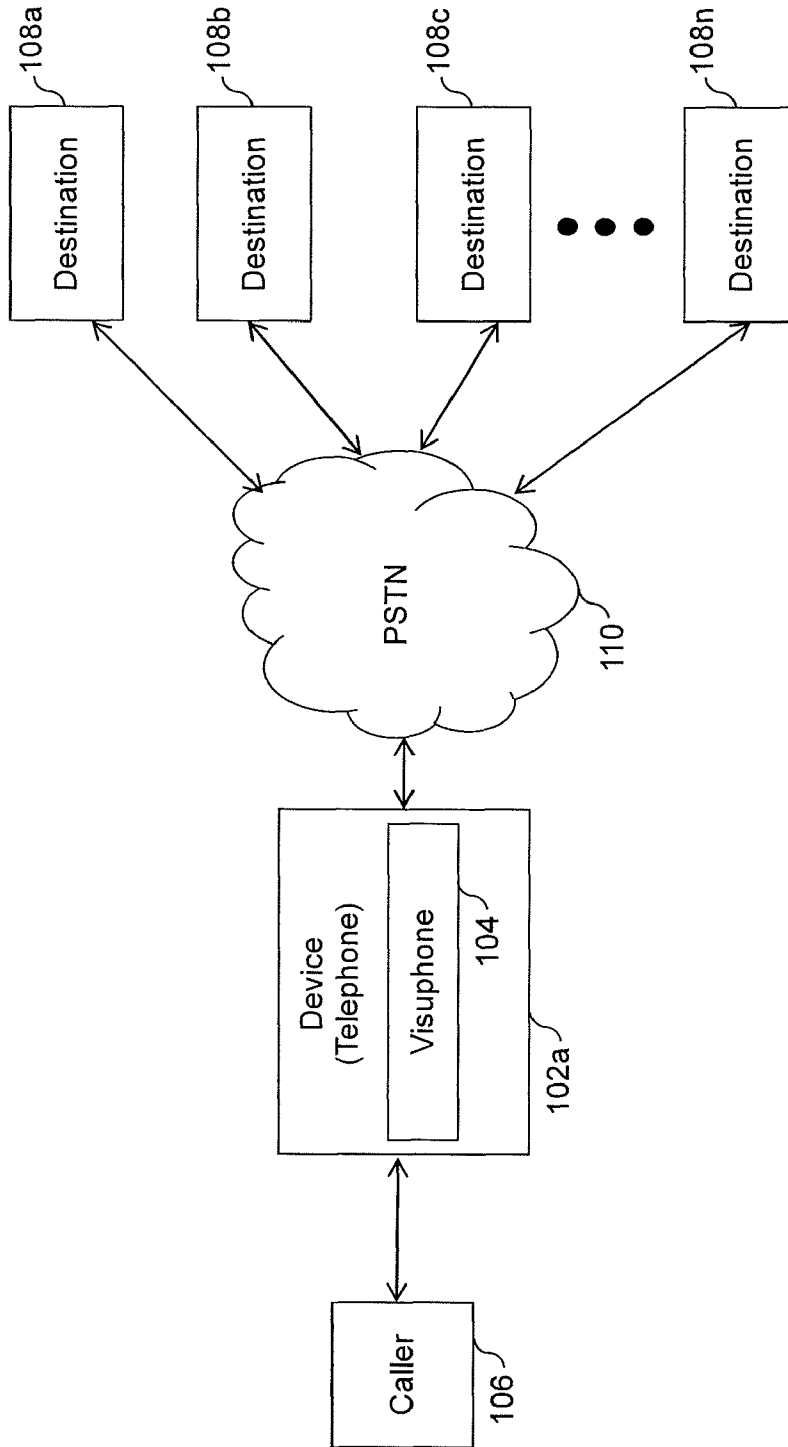

FIG. 1A

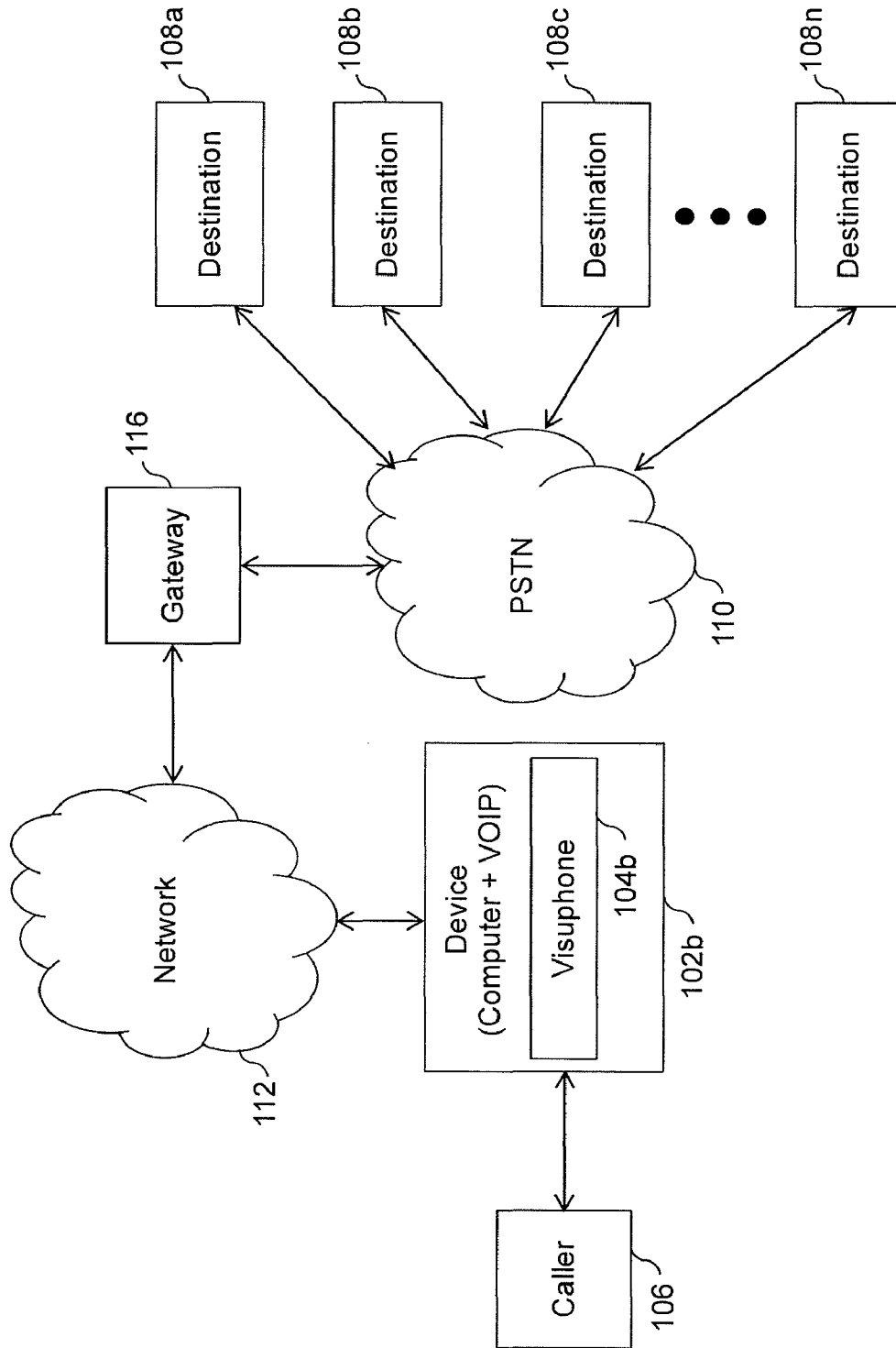

FIG. 1B

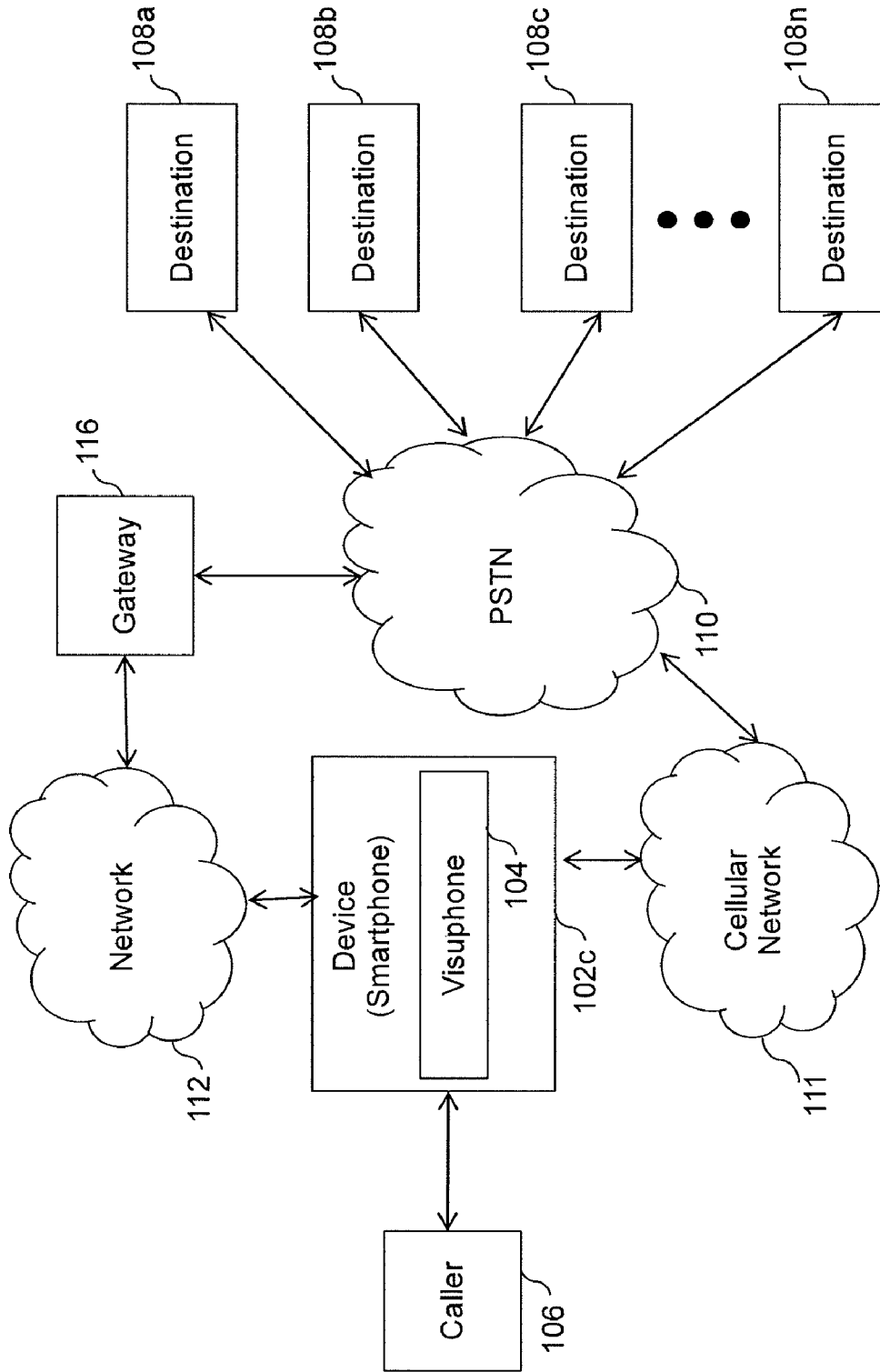

FIG. 1C

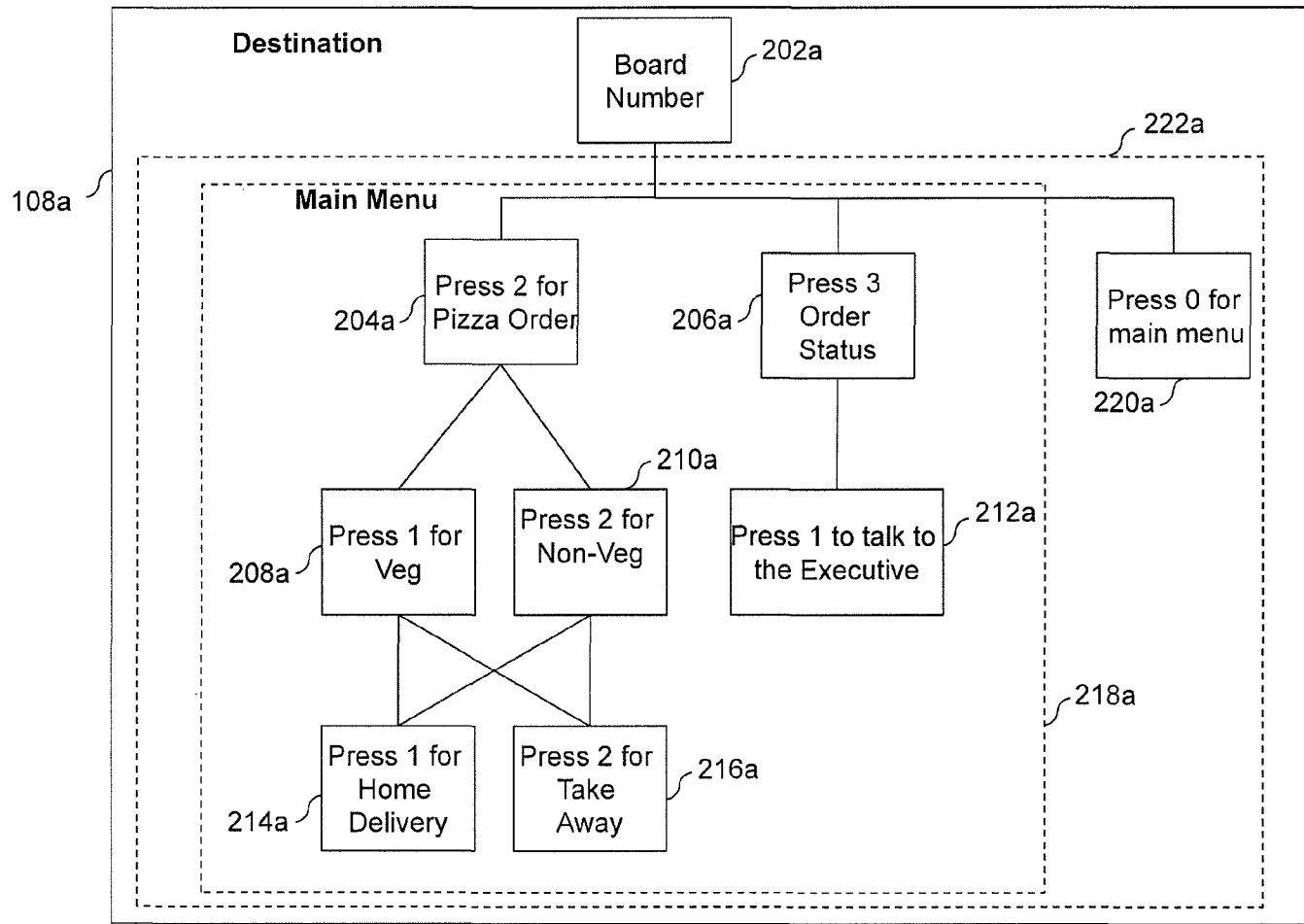

FIG. 2A

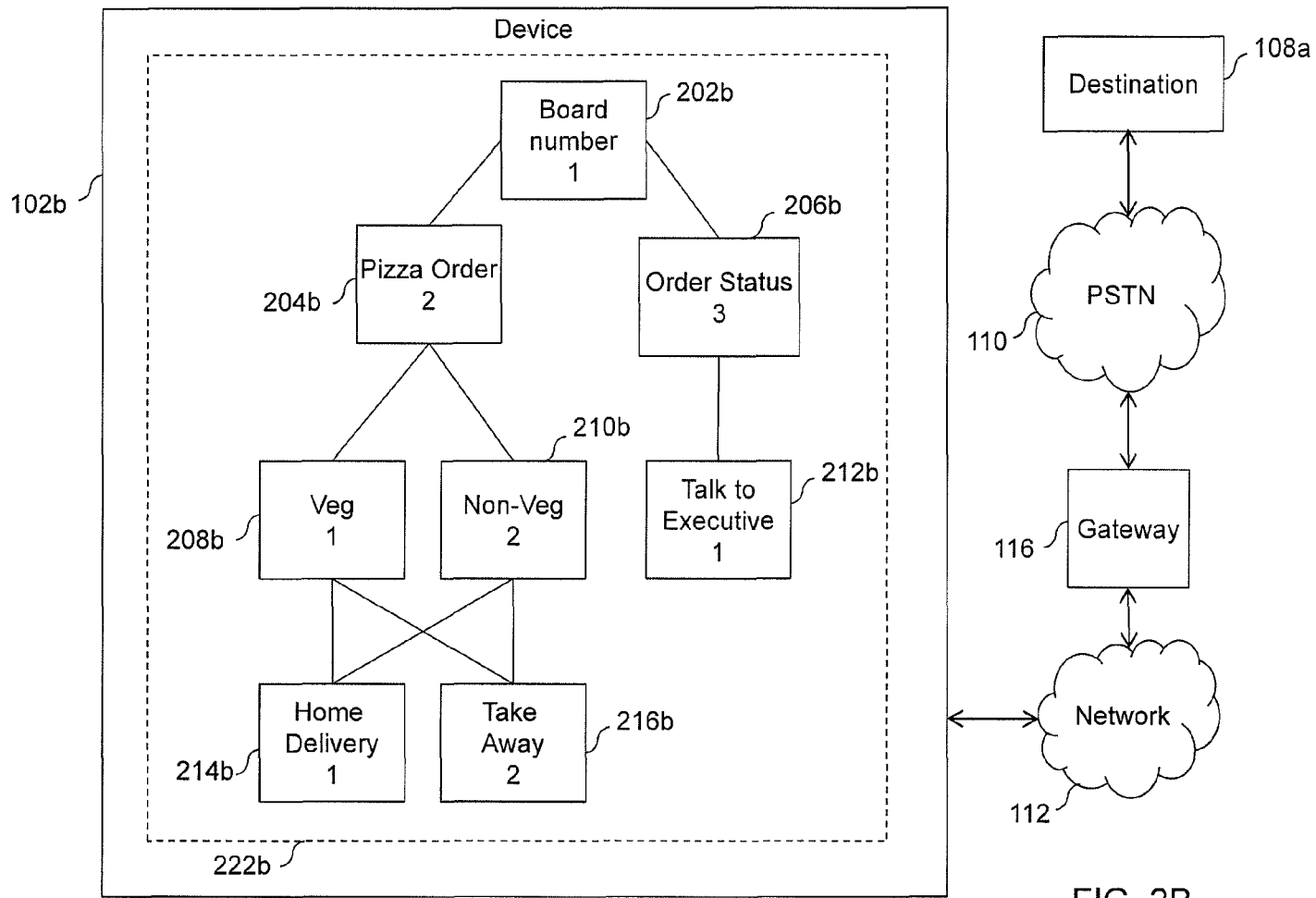

FIG. 2B

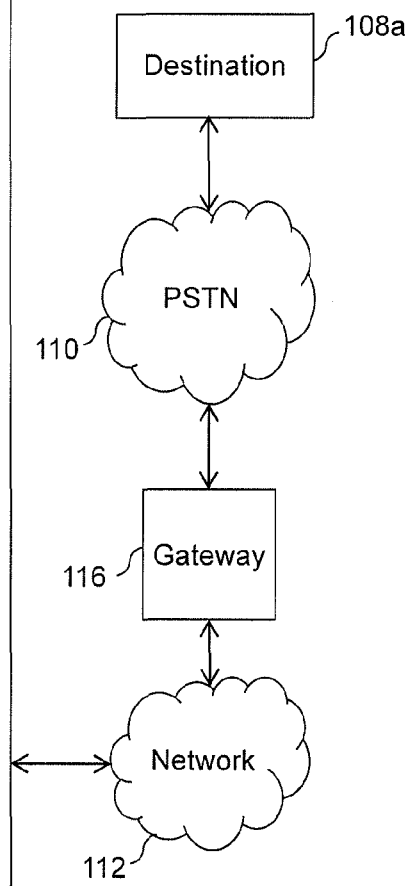
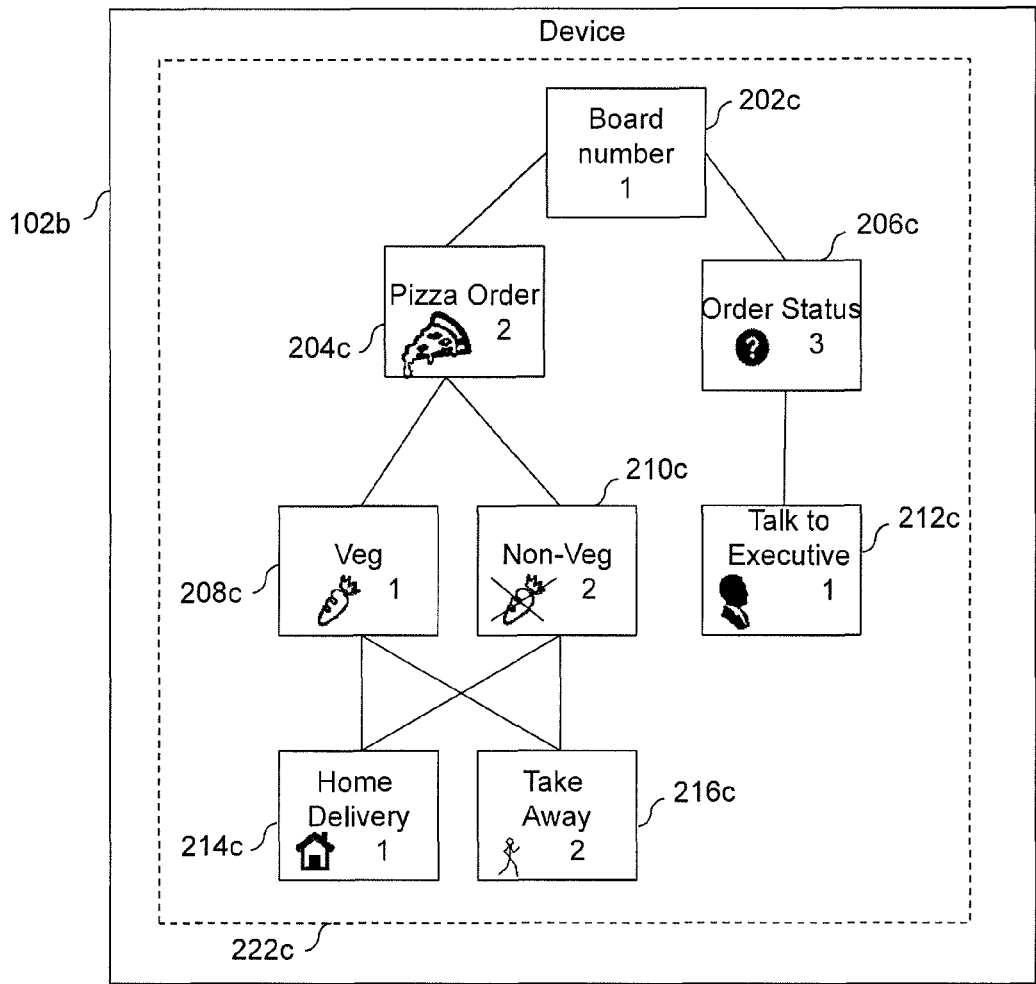

FIG. 2C

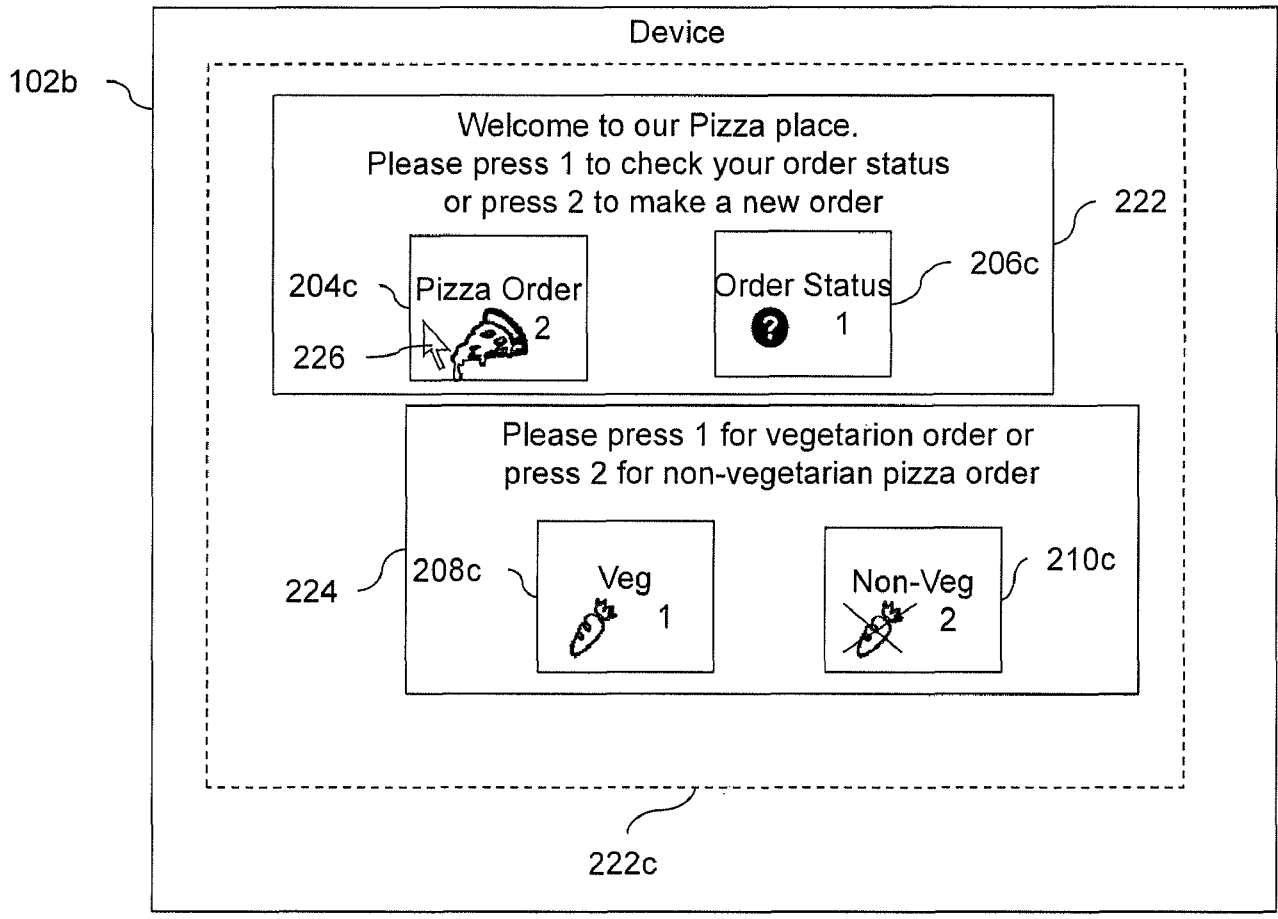

FIG. 2D

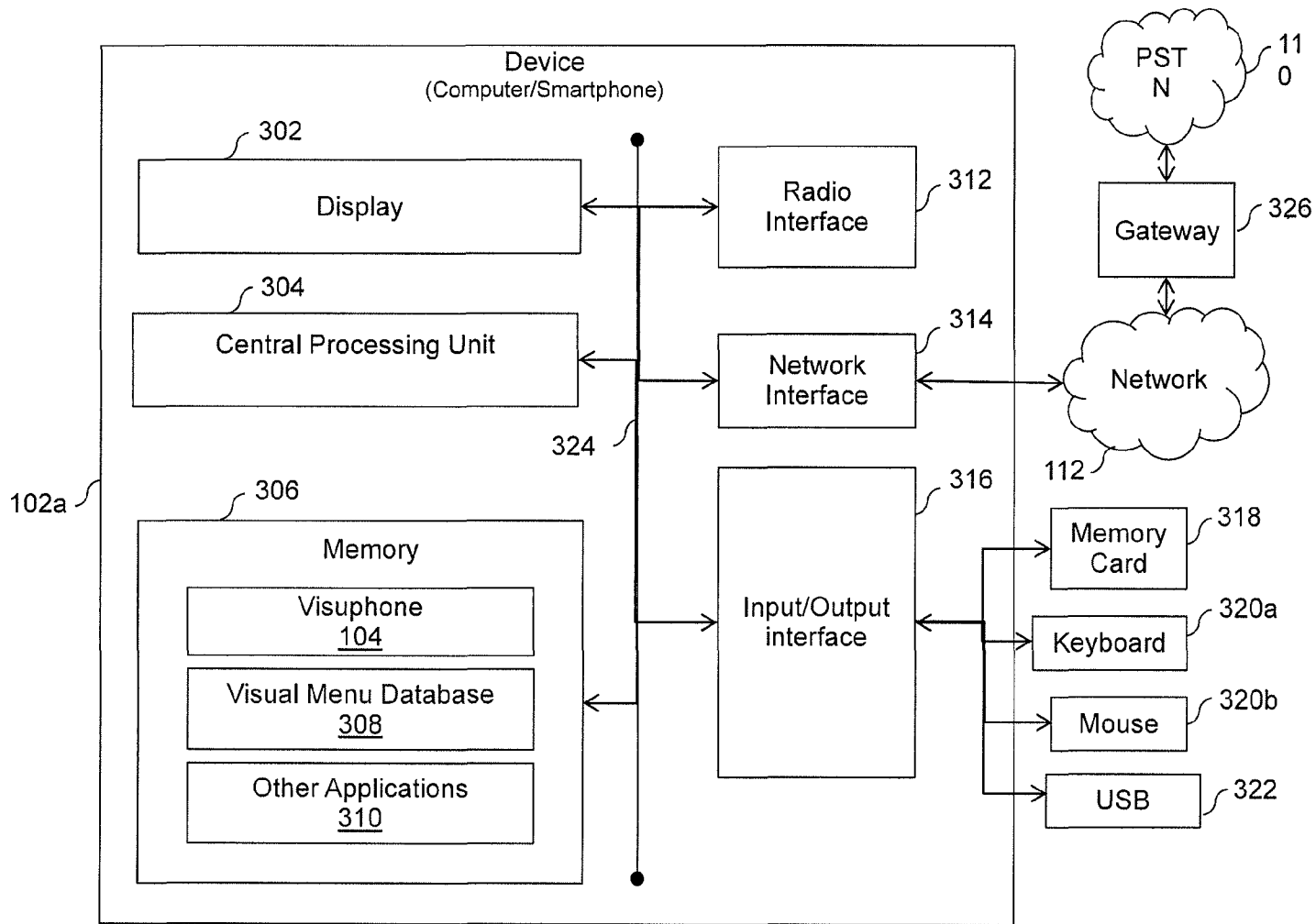

FIG. 3A

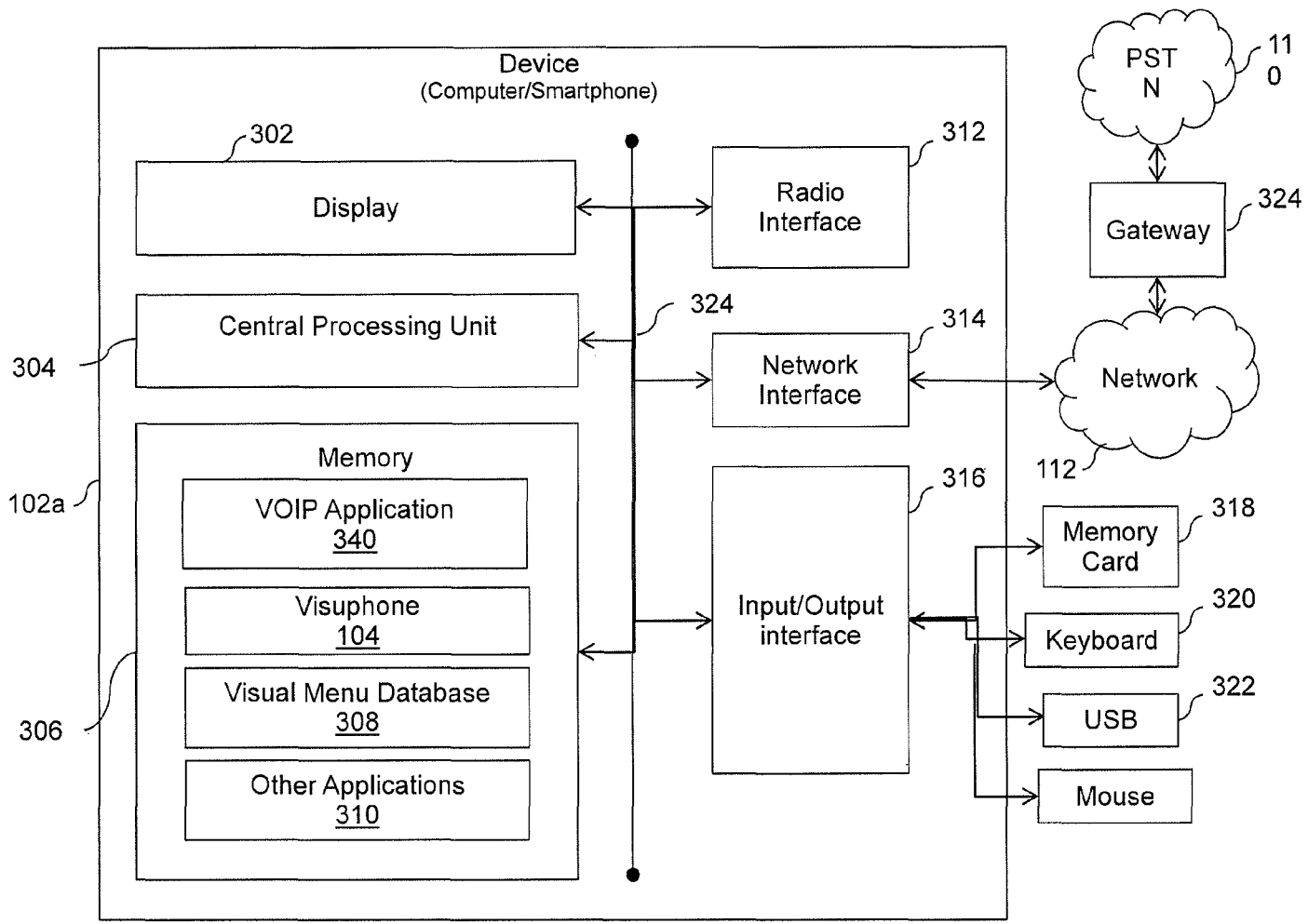

FIG. 3B

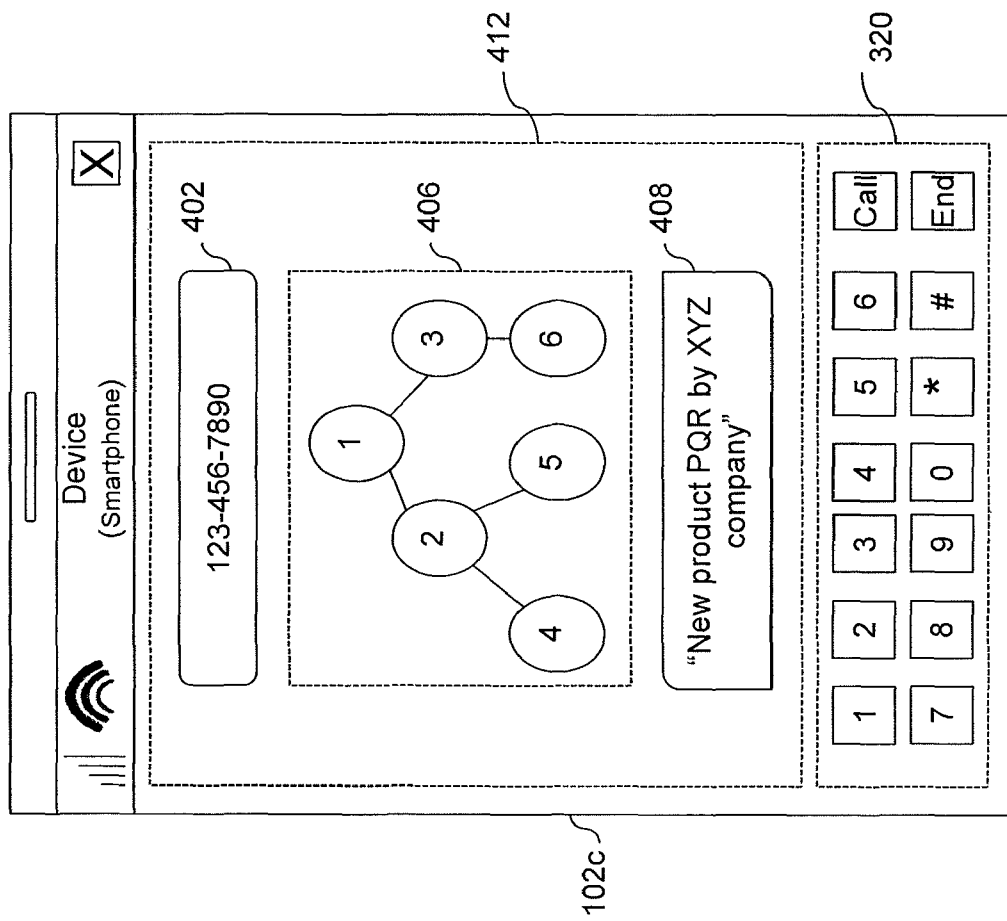

FIG. 4

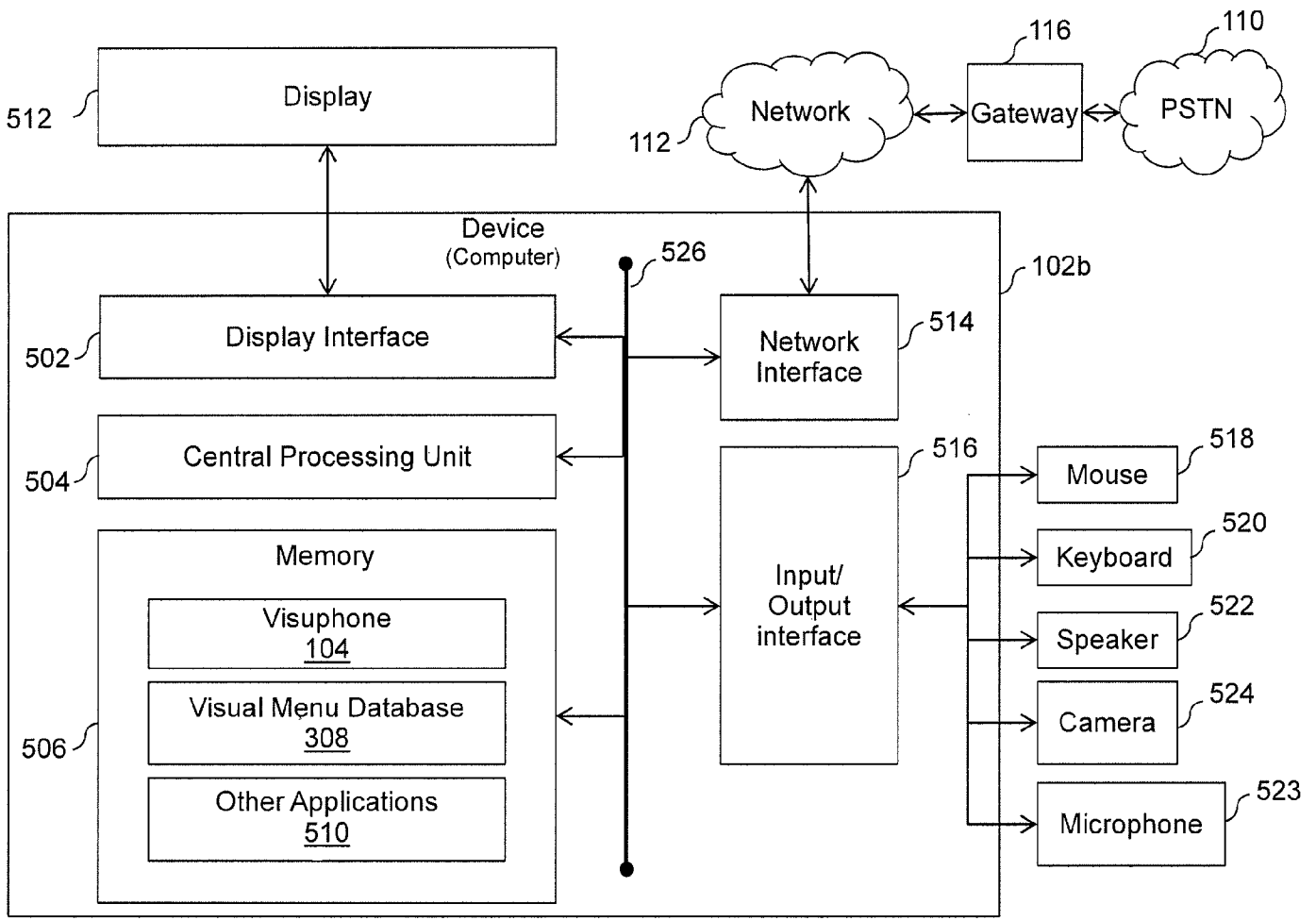

FIG. 5

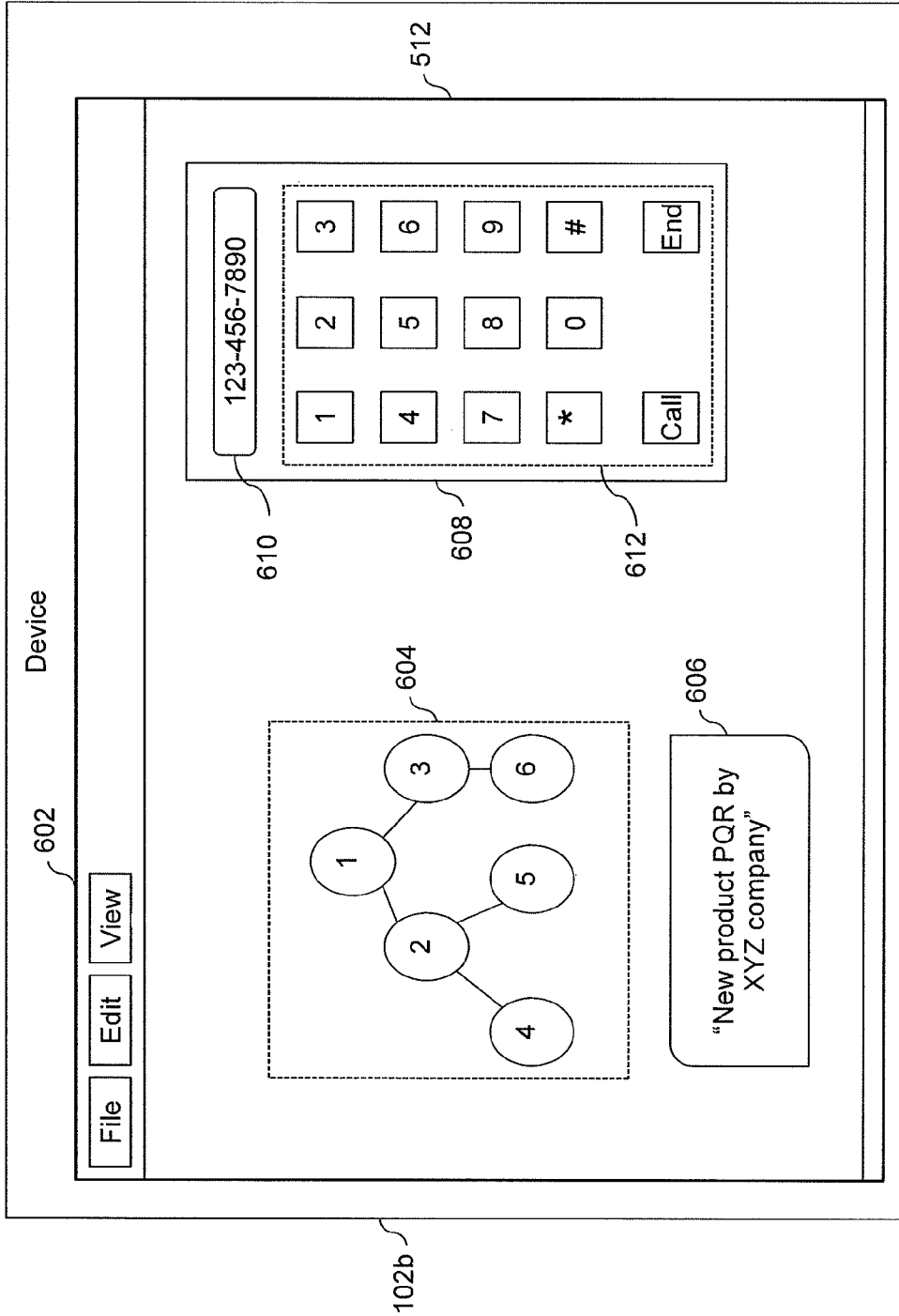

FIG. 6

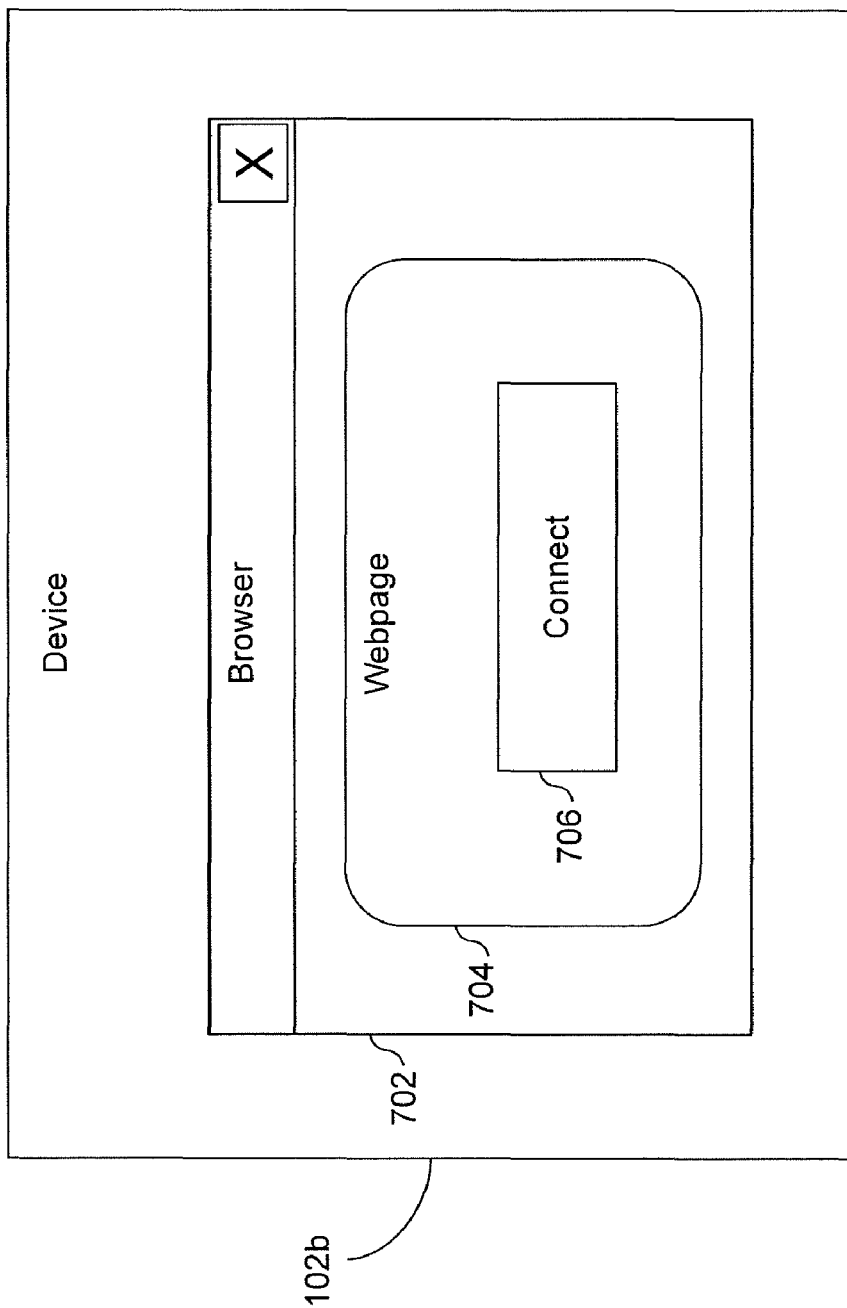

FIG. 7

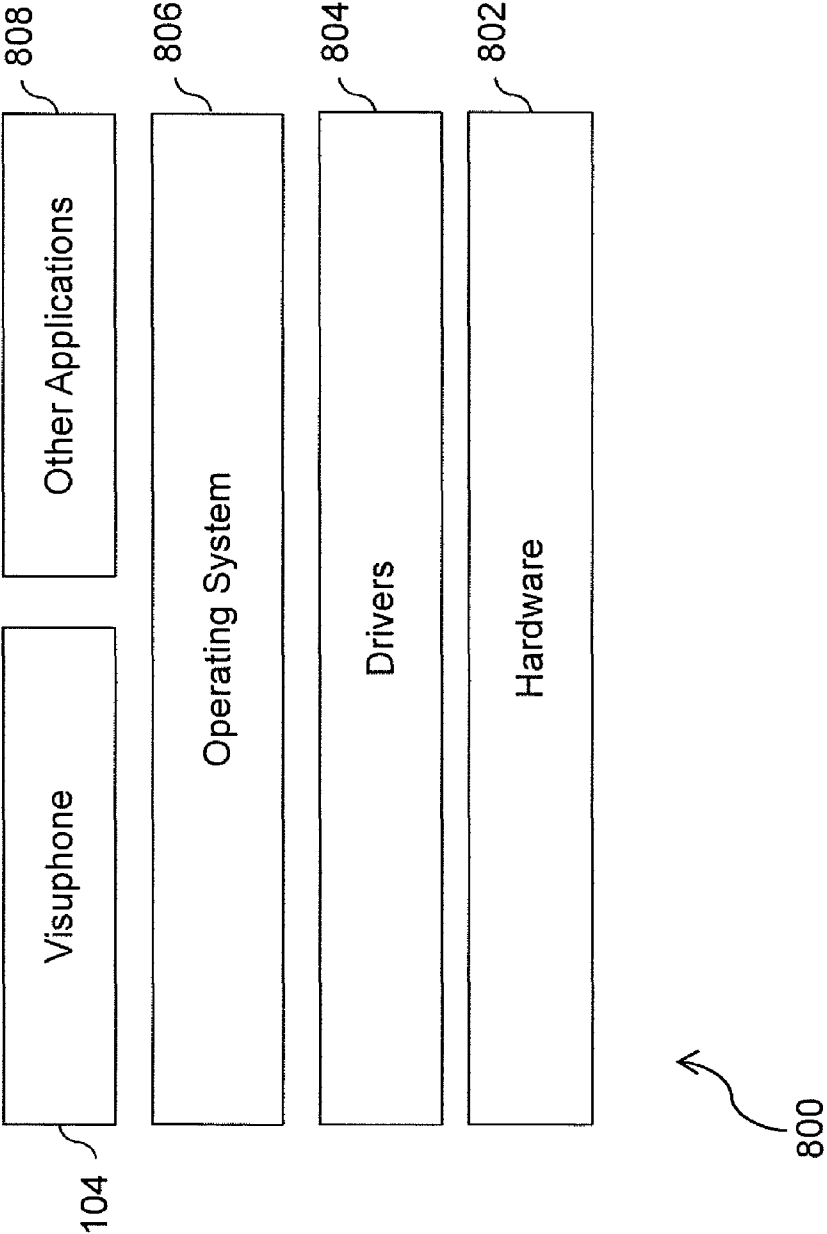

FIG. 8

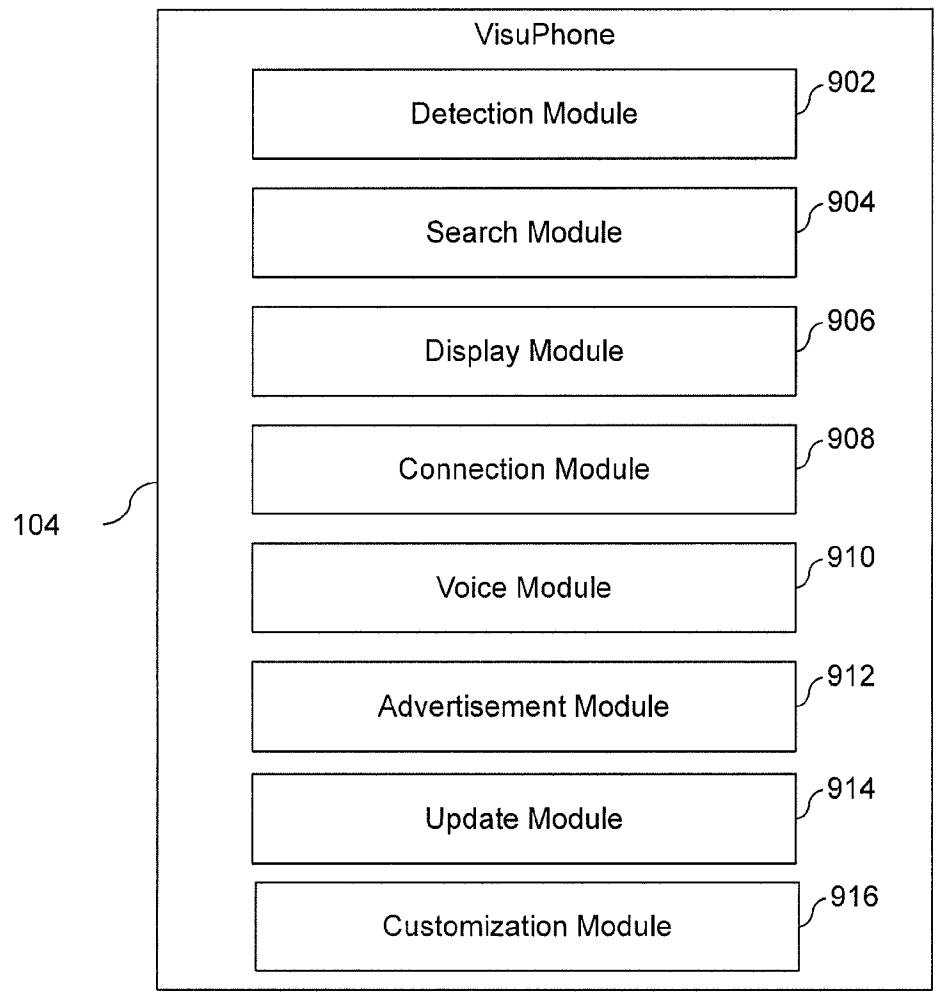

FIG. 9

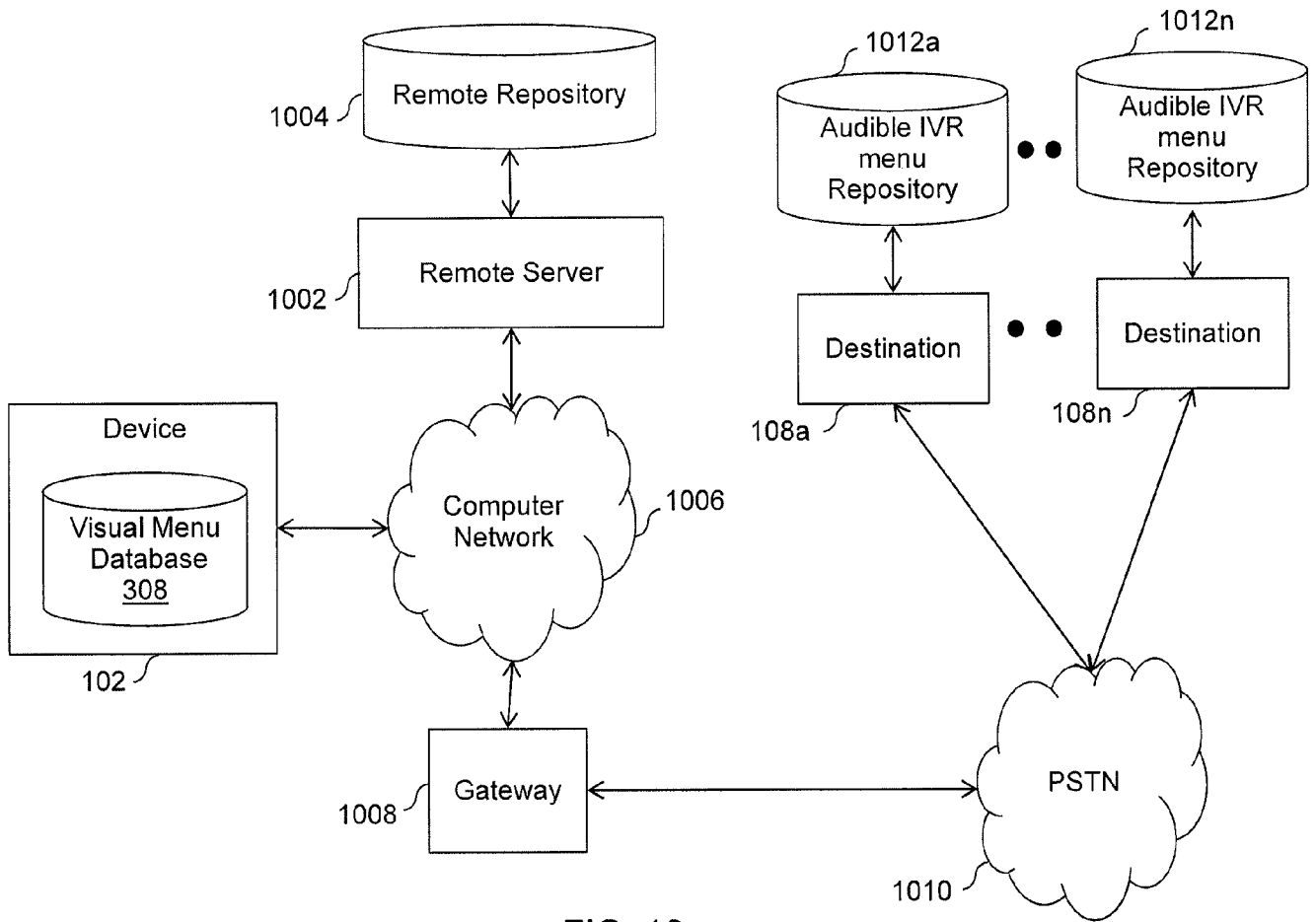

FIG. 10

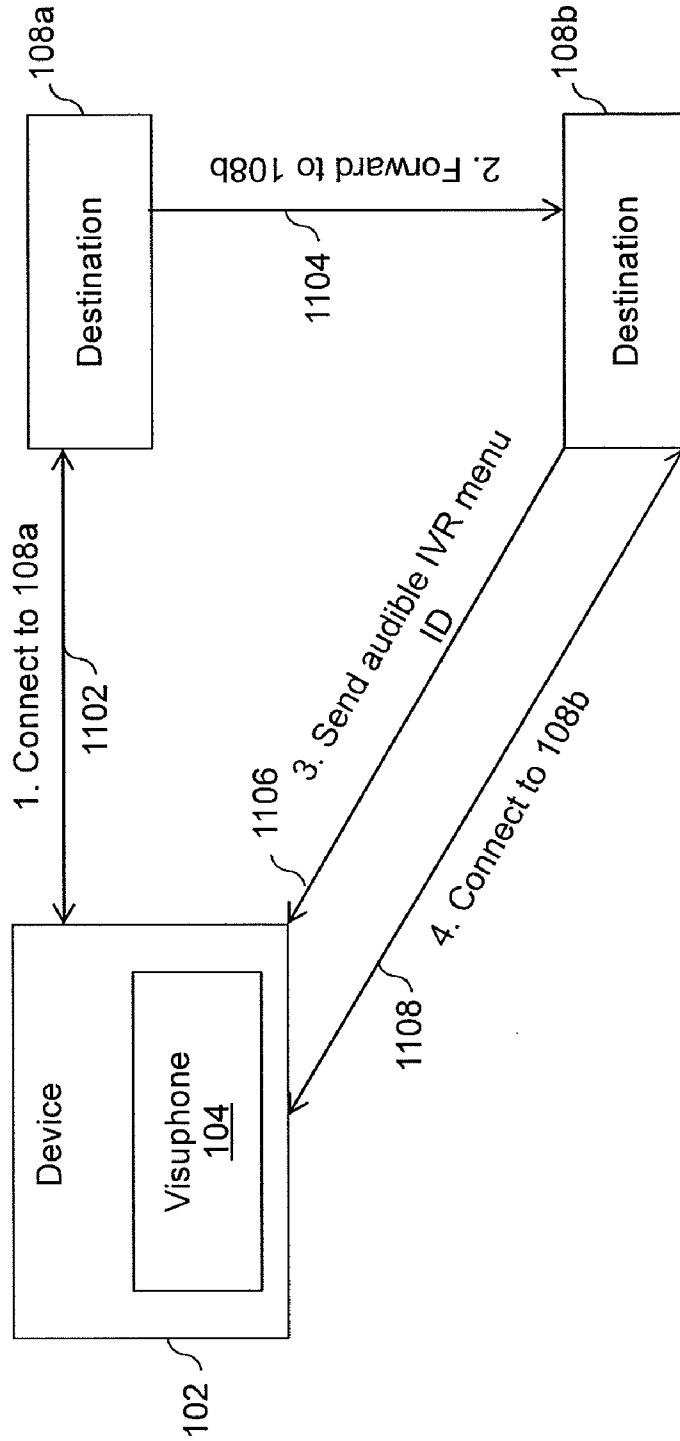

FIG. 11

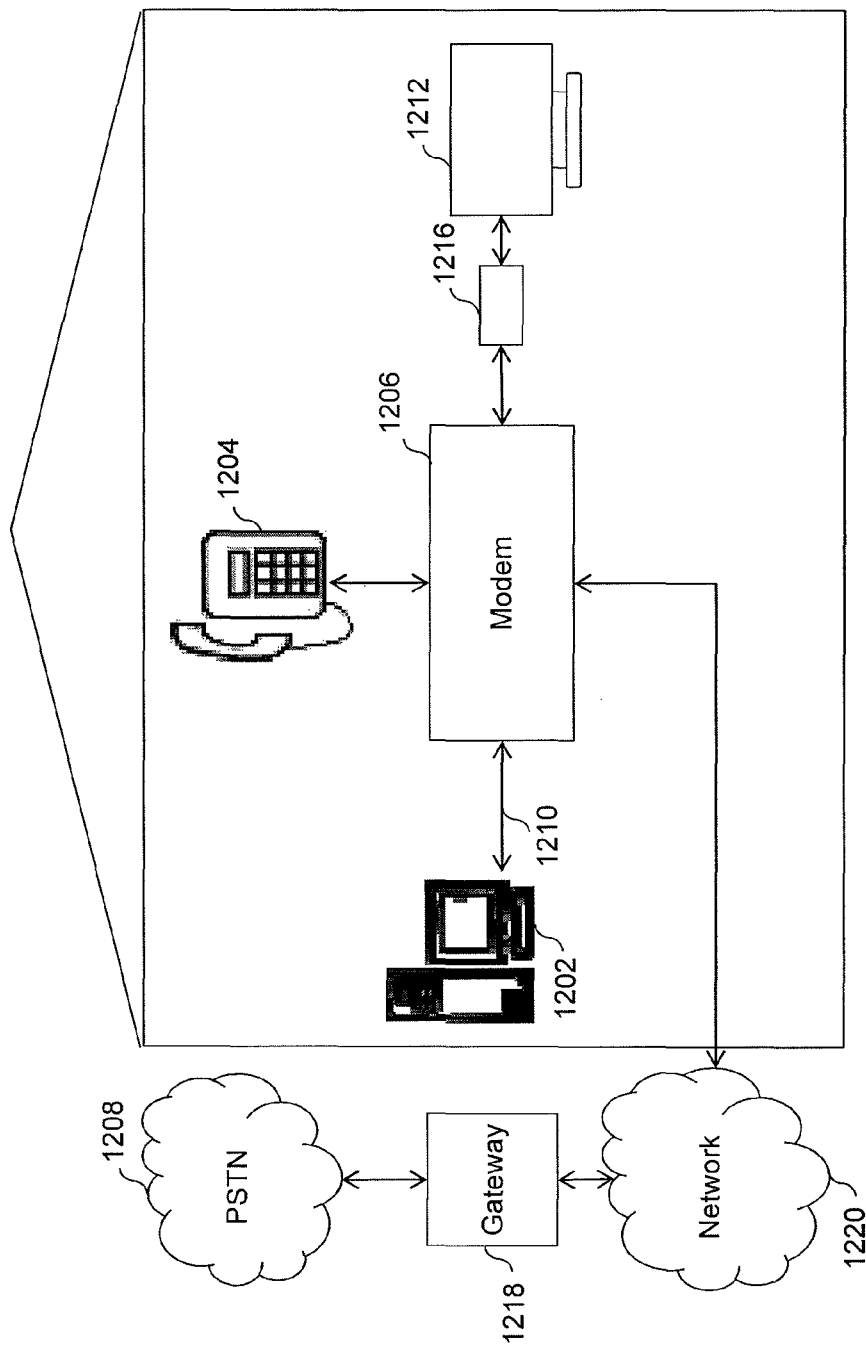

FIG. 12

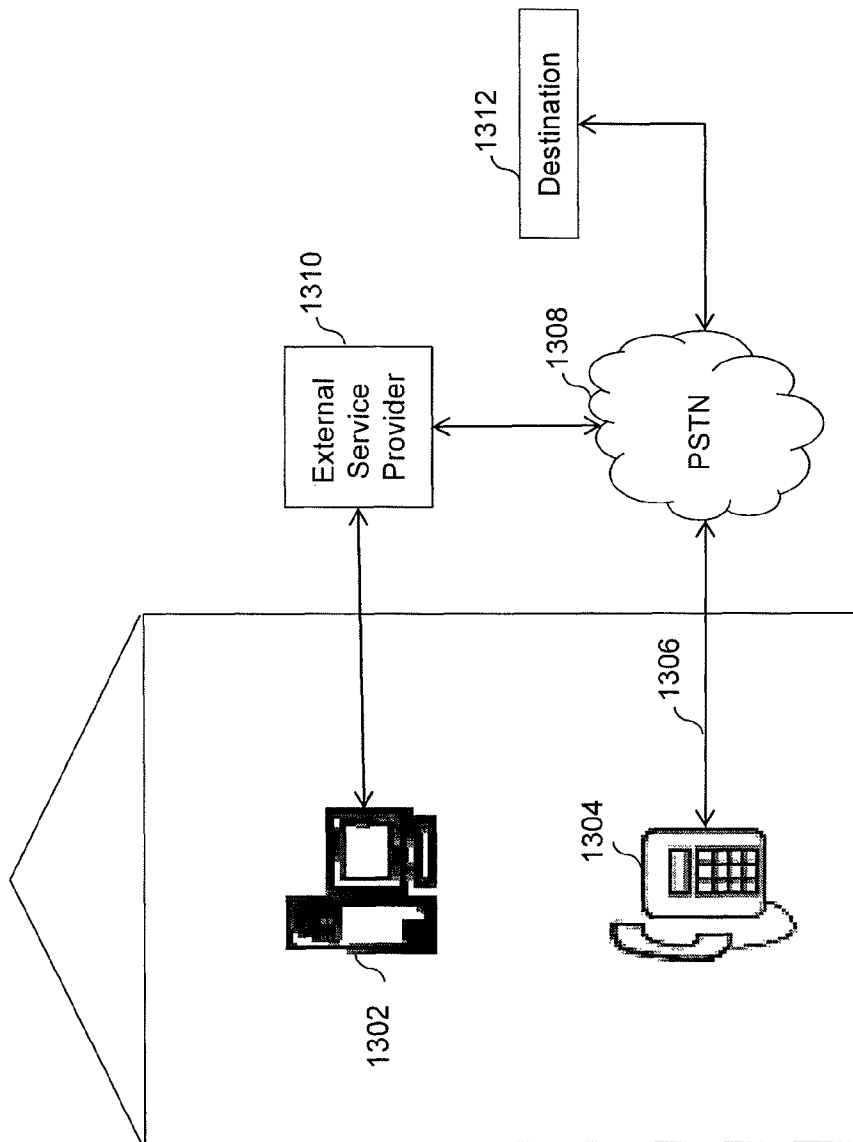

FIG. 13

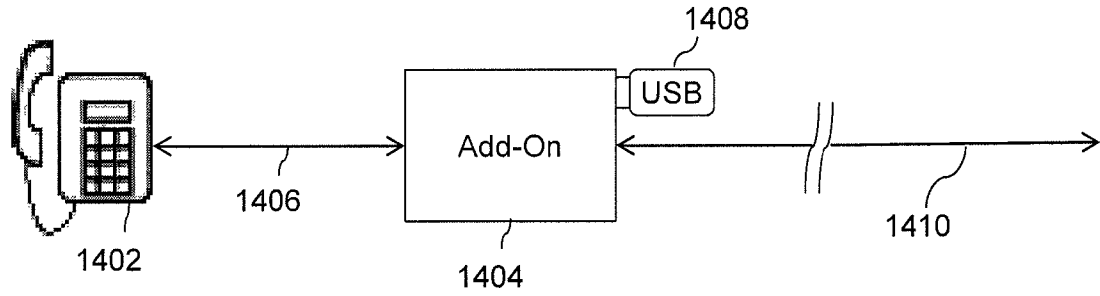

FIG. 14A

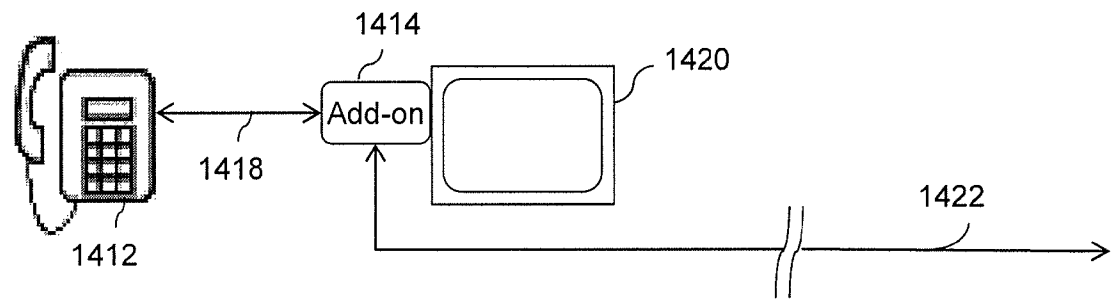

FIG. 14B

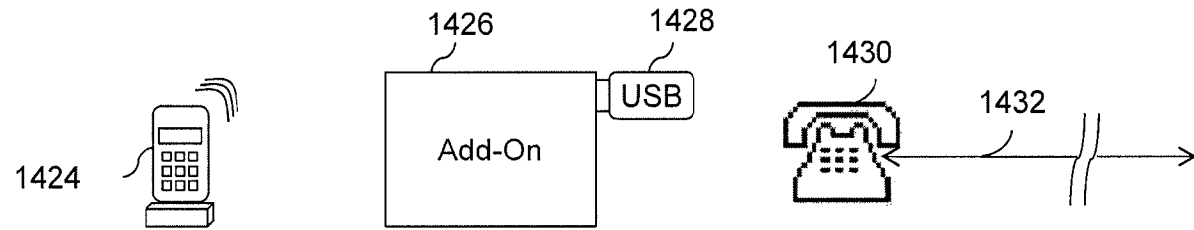

FIG. 14C

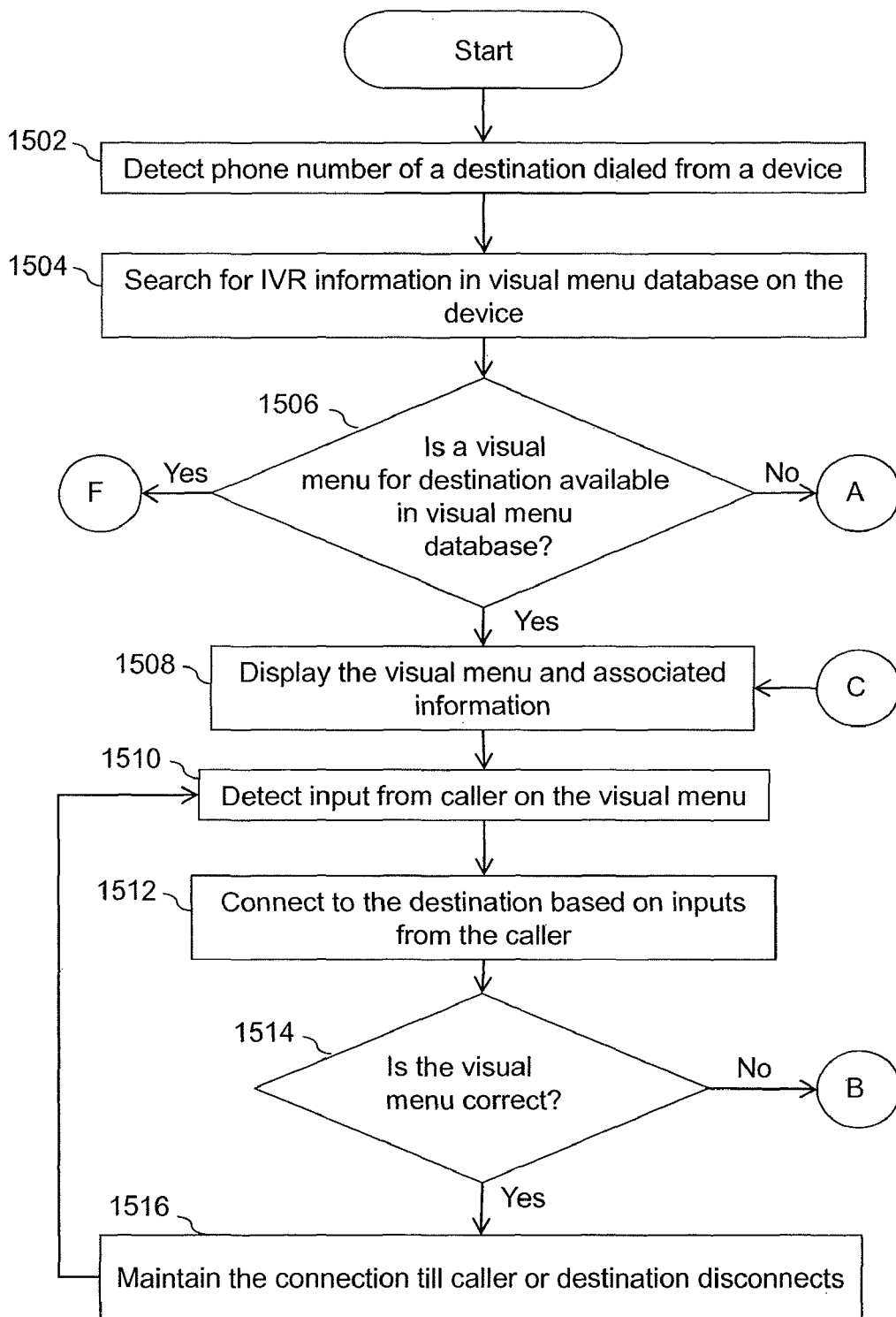

FIG. 15A

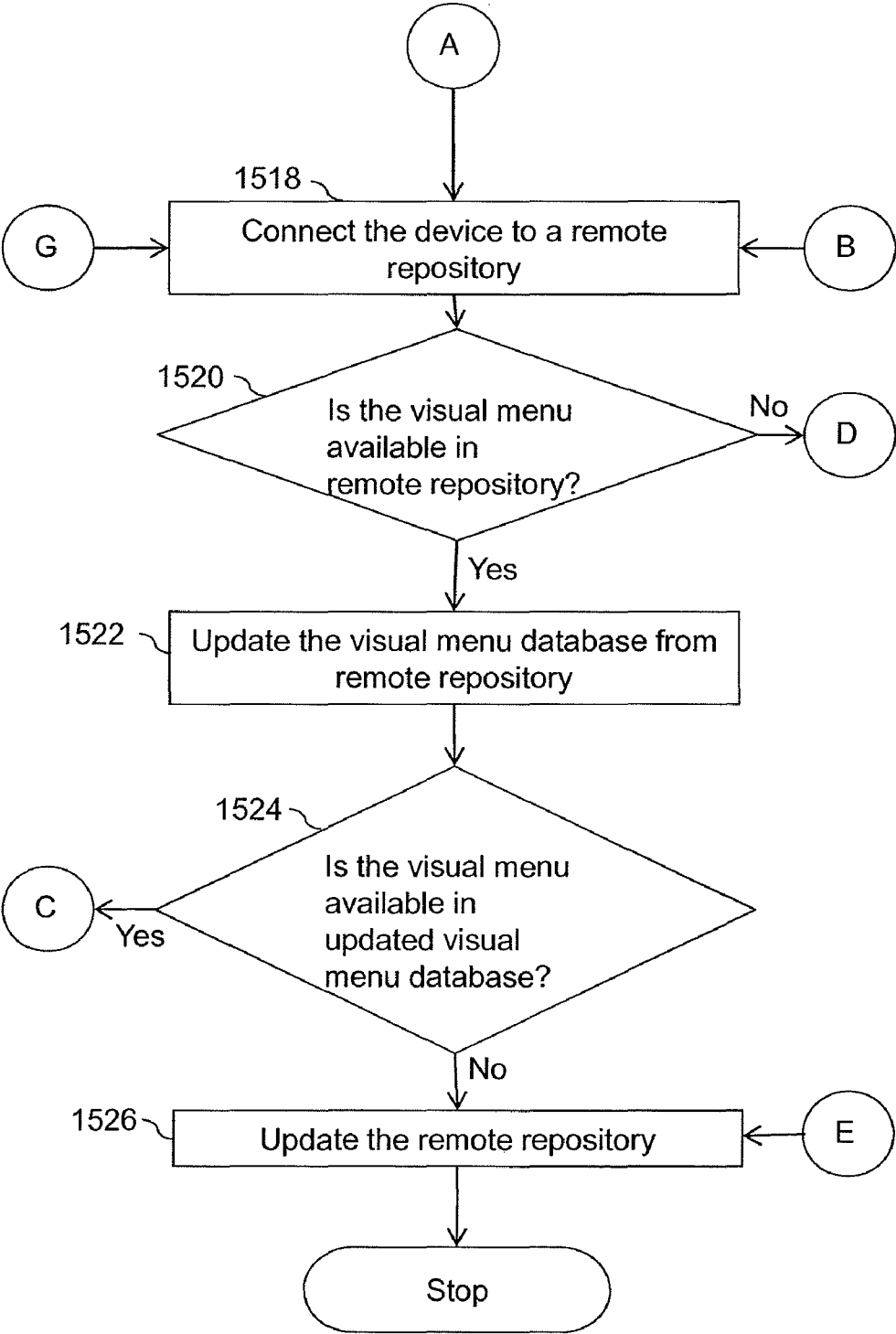

FIG. 15B

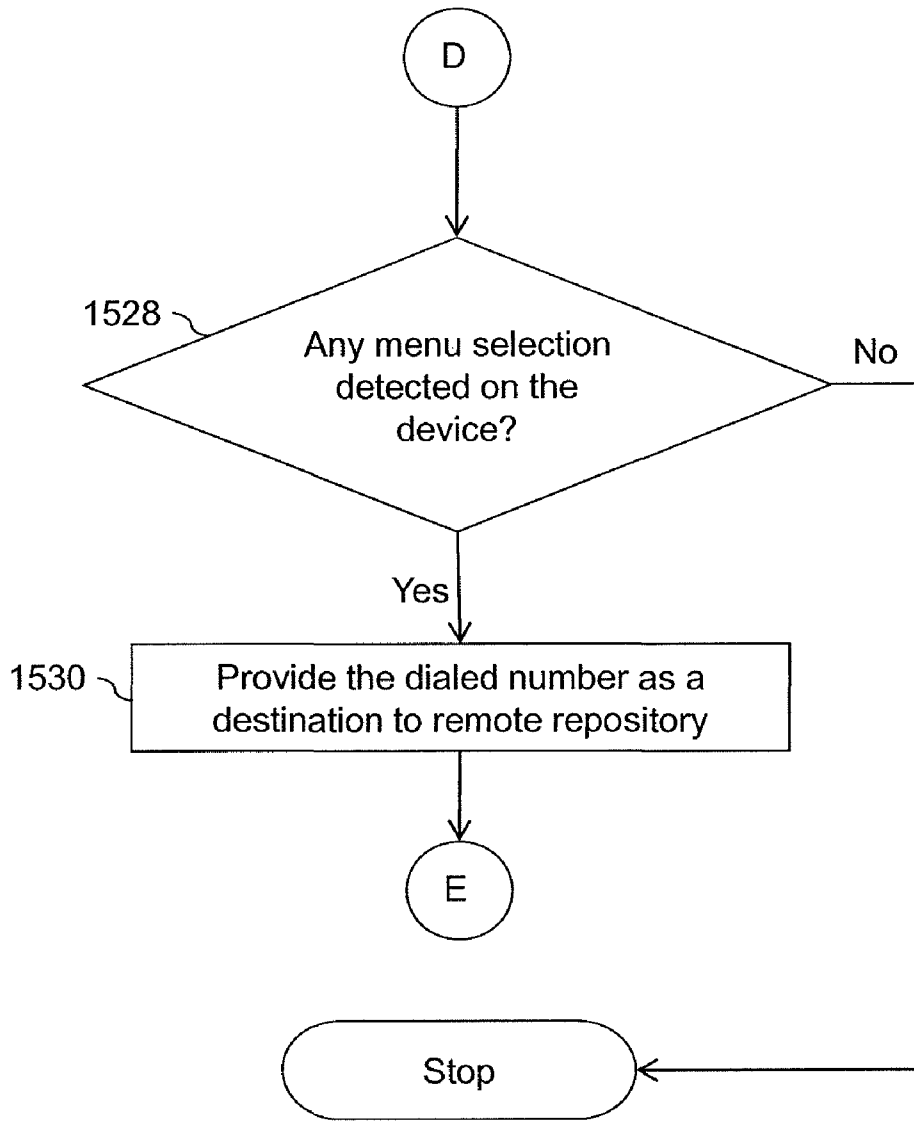

FIG. 15C

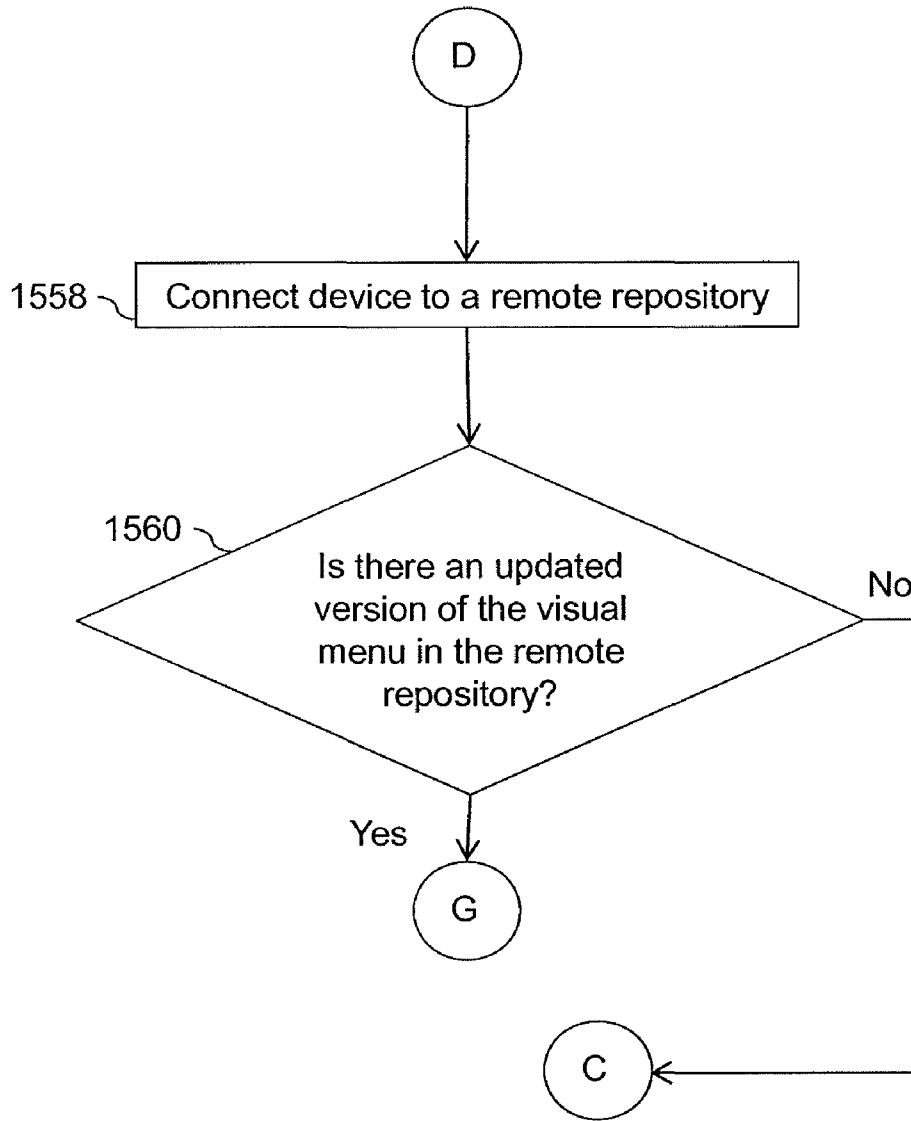

FIG. 15D

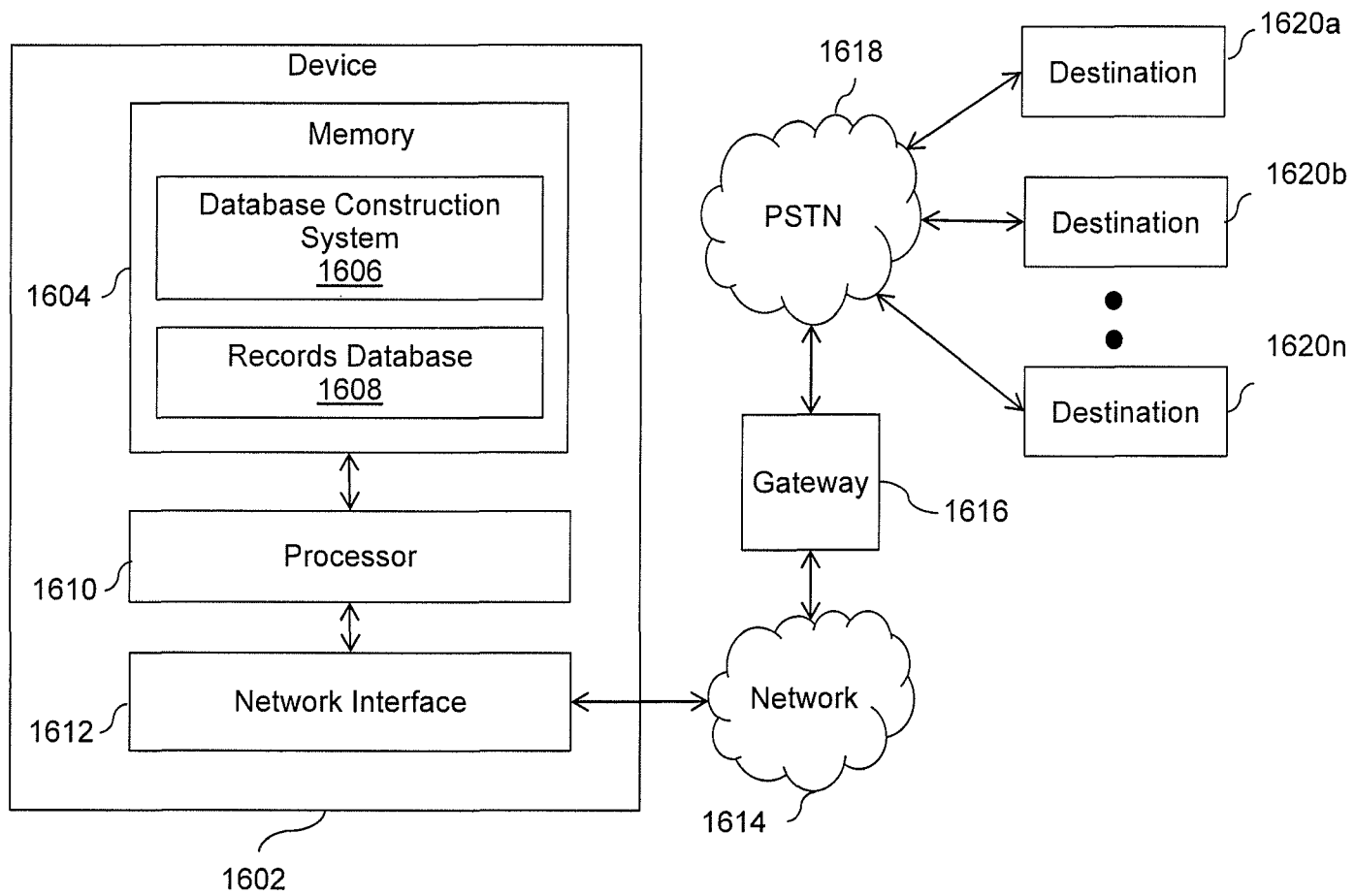

FIG. 16

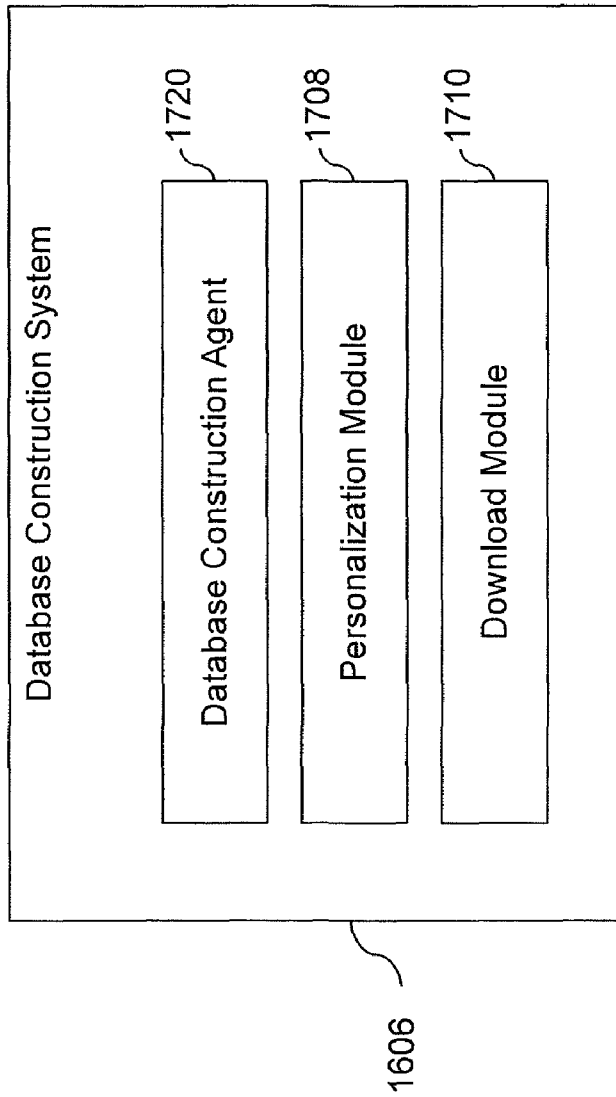

FIG. 17A

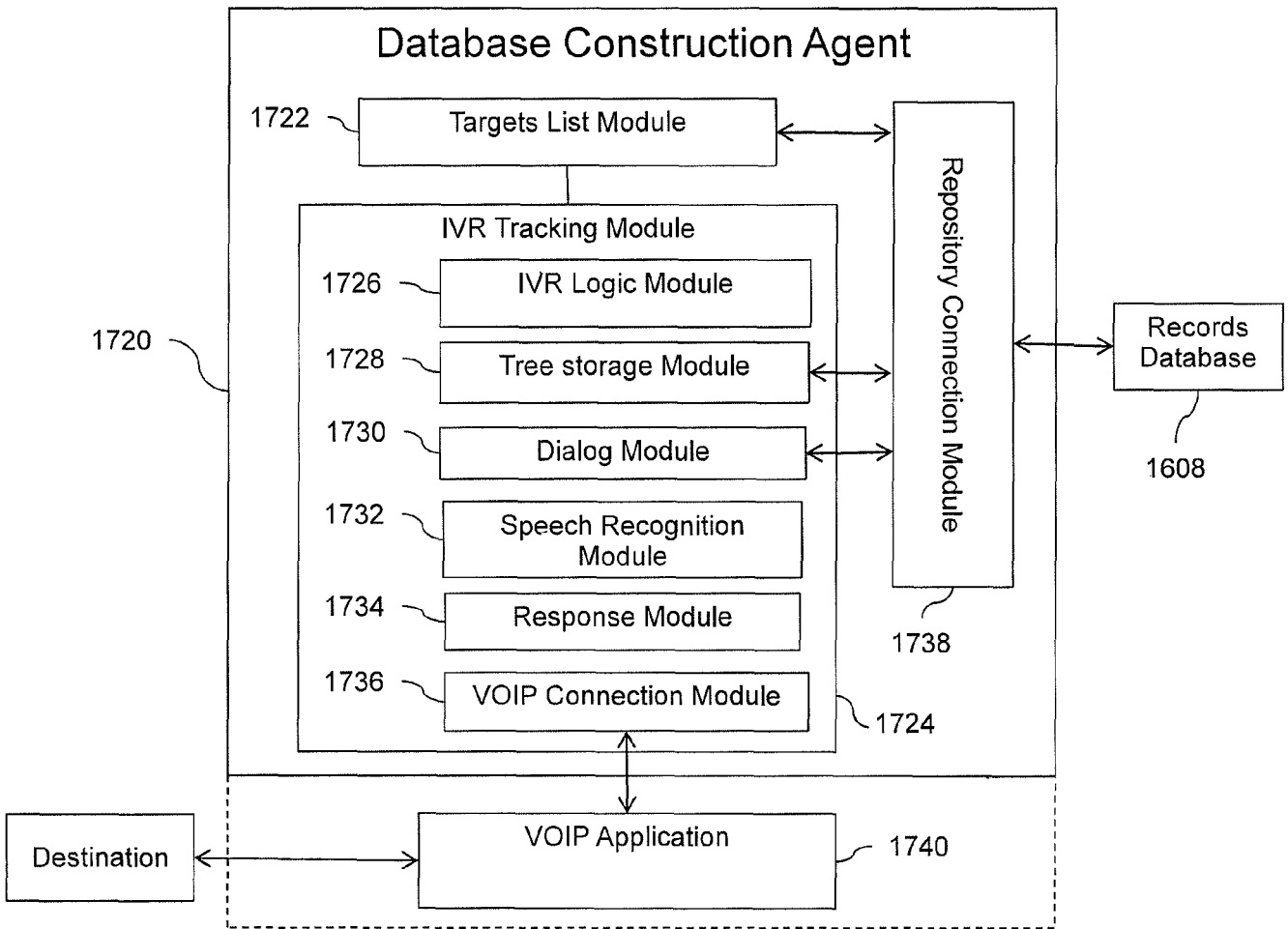

FIG. 17B

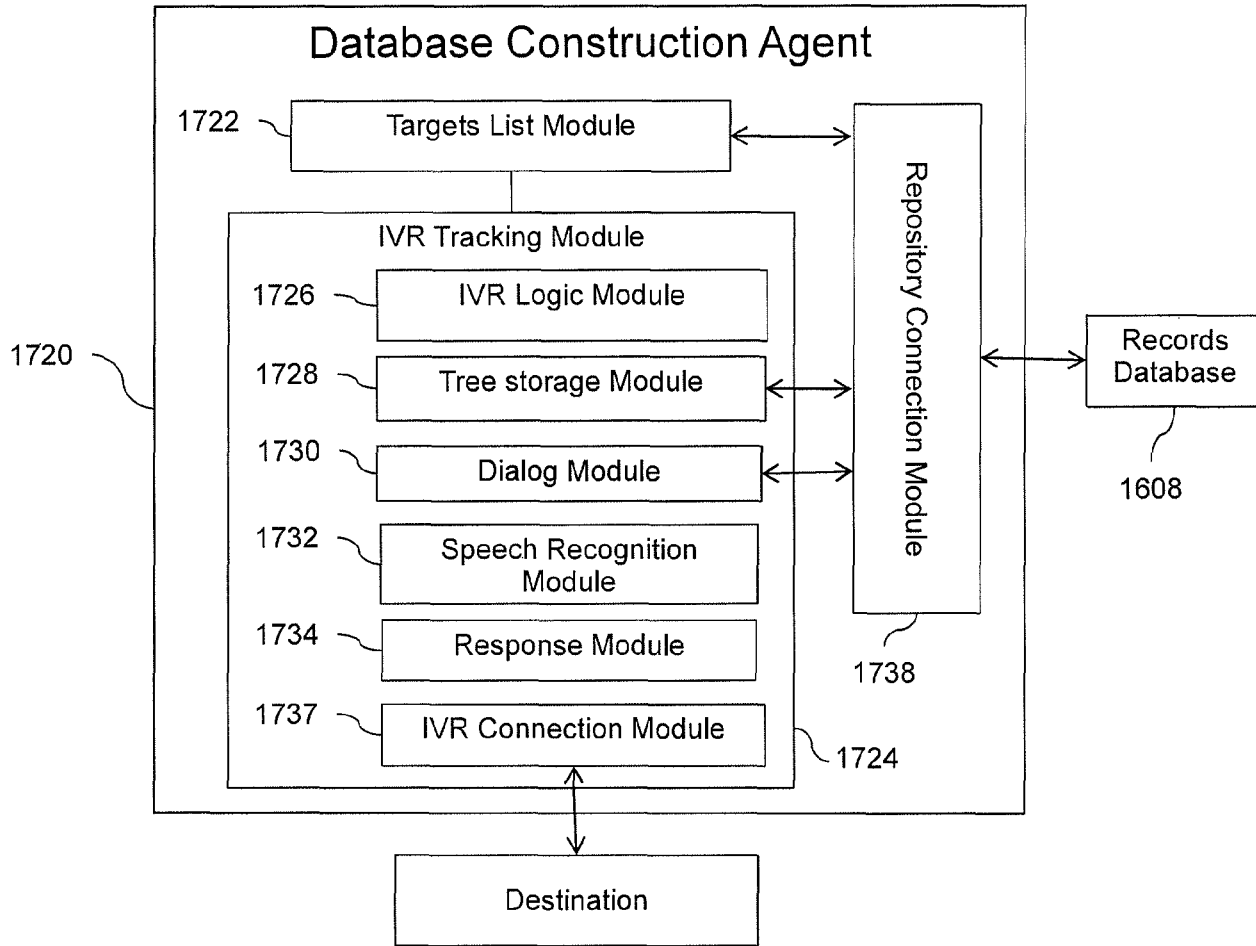

FIG. 17C

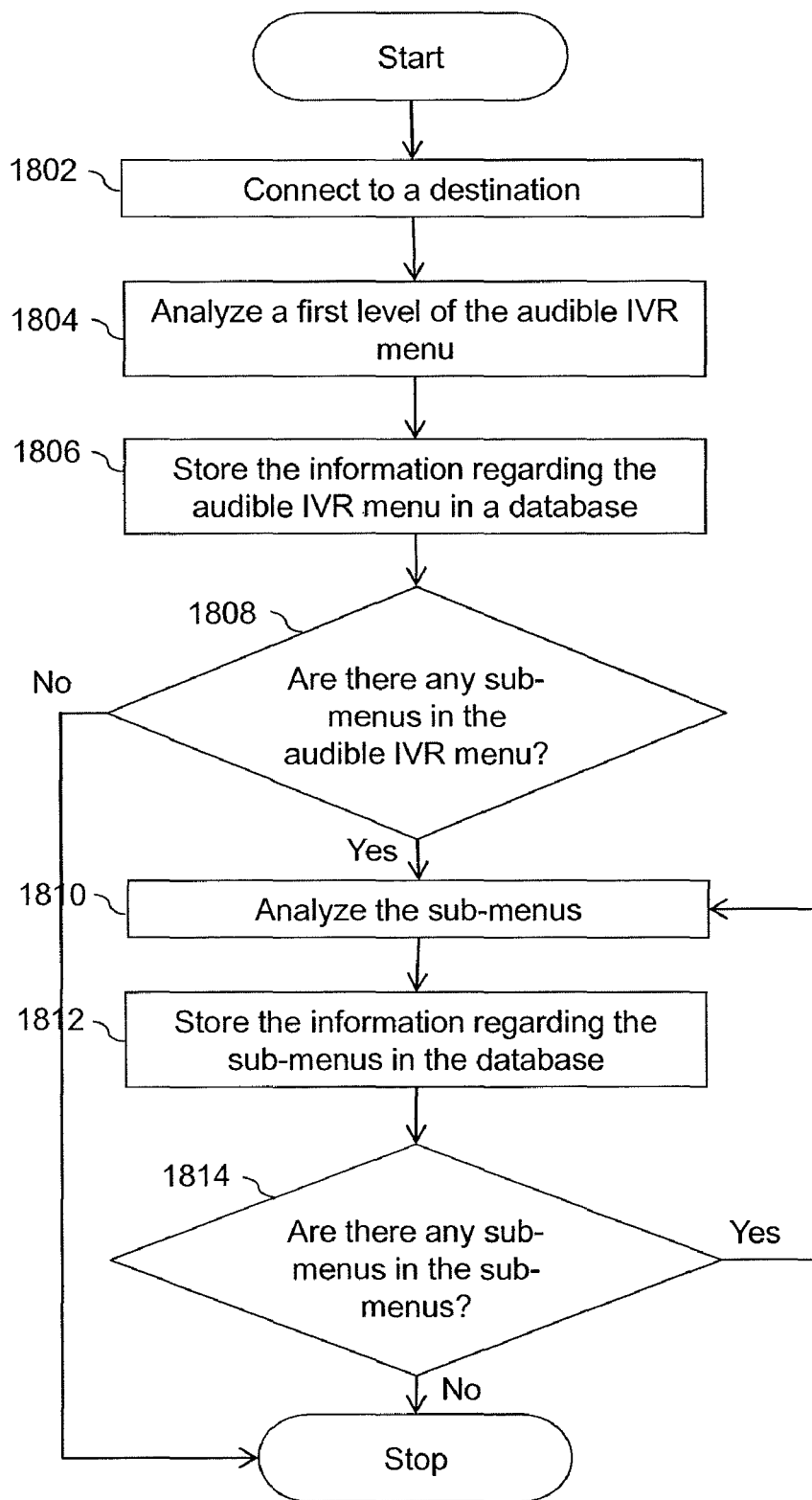

FIG. 18

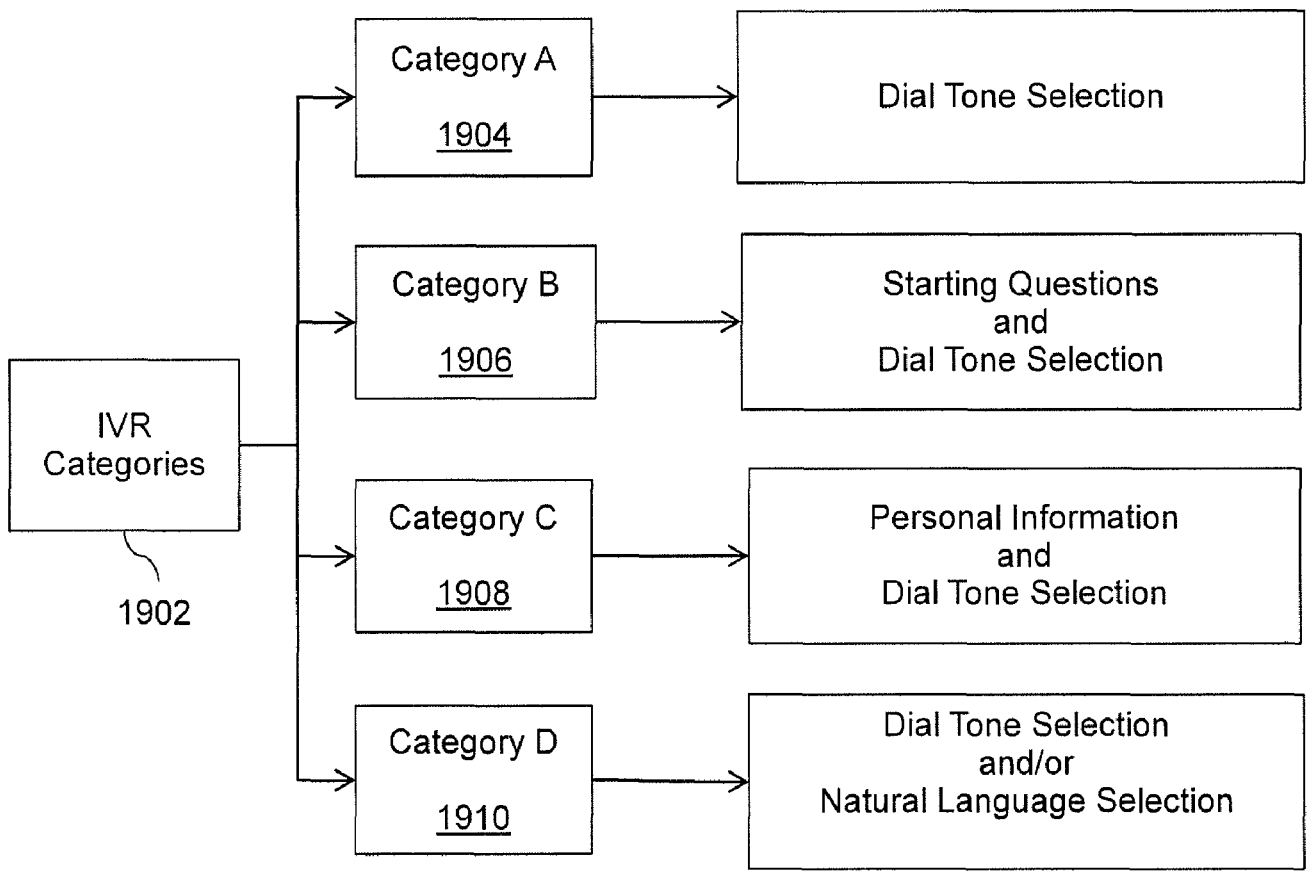

FIG. 19

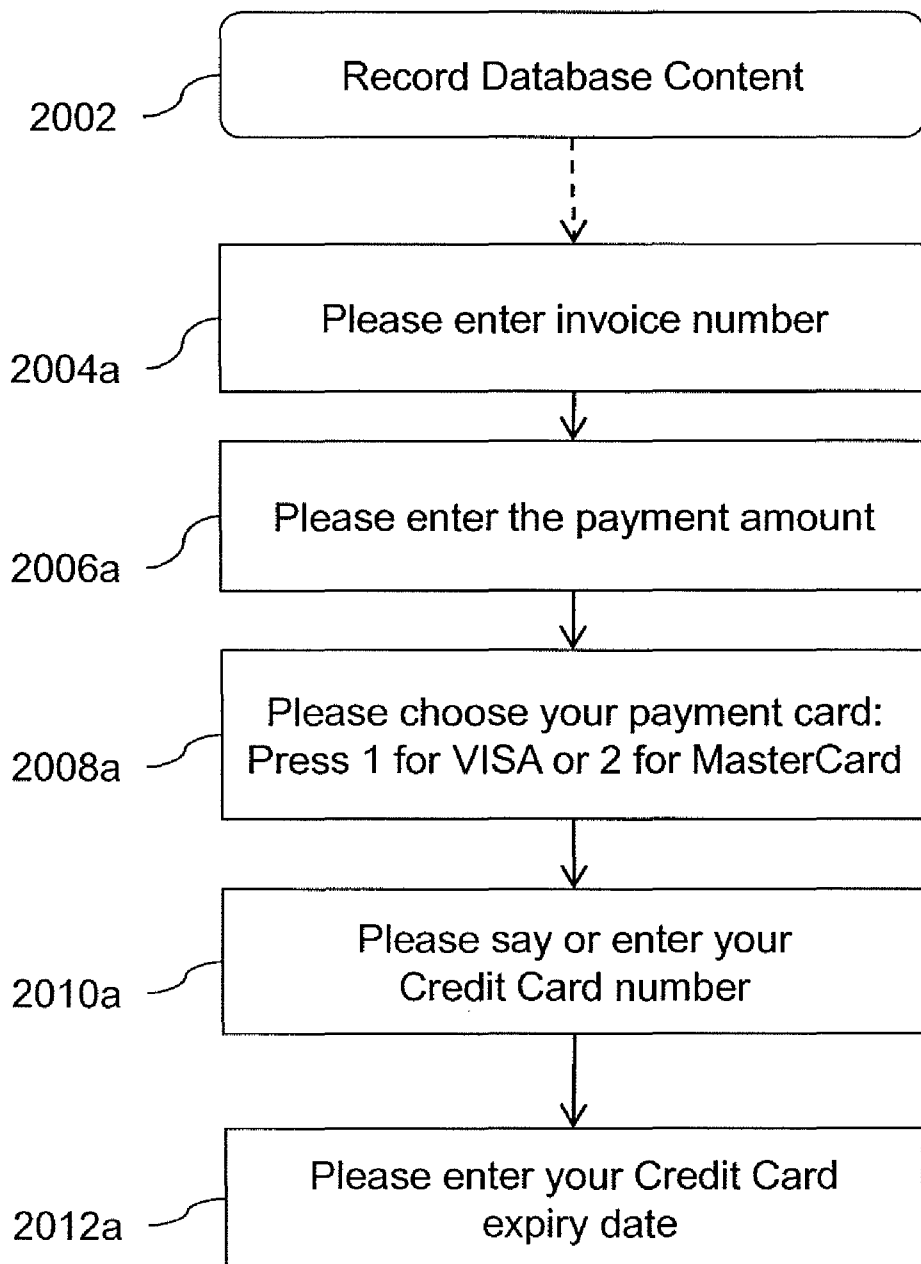

FIG.20A

Payment Form for ABC

2004b Please enter invoice number:

2006b Please enter the payment amount

2008b Please choose your payment card:
 VISA MasterCard

2010b Please enter your Credit Card number

2012b Please enter your Credit Card expiry date

⋮

2016

The diagram shows a payment form titled "Payment Form for ABC" enclosed in a rectangular border labeled 2014. The form contains five dashed-line boxes, each with a label on the left and a text prompt above a text input field. The first box is labeled 2004b and contains the prompt "Please enter invoice number:". The second box is labeled 2006b and contains "Please enter the payment amount". The third box is labeled 2008b and contains "Please choose your payment card:" followed by two radio button options: "VISA" (with the radio button selected) and "MasterCard". The fourth box is labeled 2010b and contains "Please enter your Credit Card number". The fifth box is labeled 2012b and contains "Please enter your Credit Card expiry date". Below these boxes is a vertical dotted line. At the bottom of the form is a rounded rectangular button labeled 2016 with the text "Submit".

FIG.20B

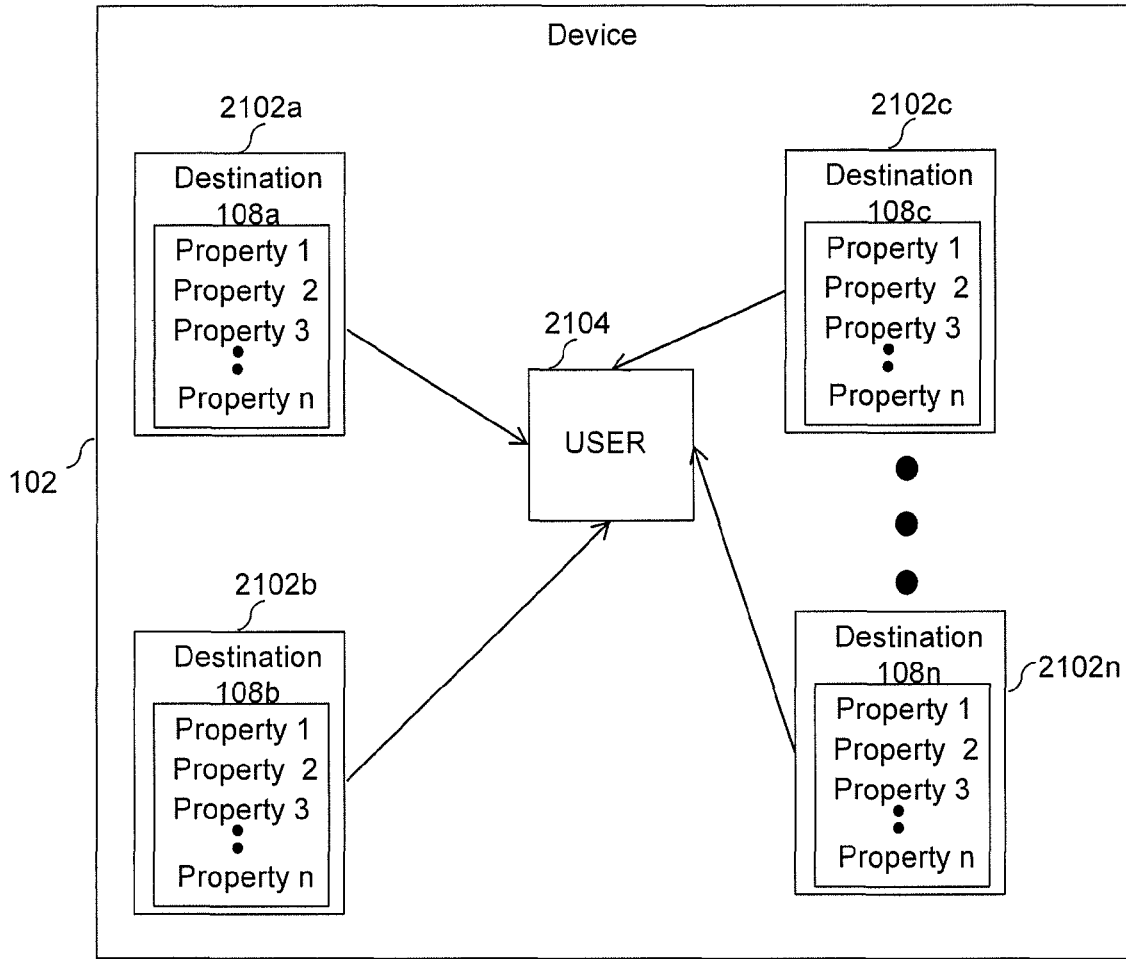

FIG. 21

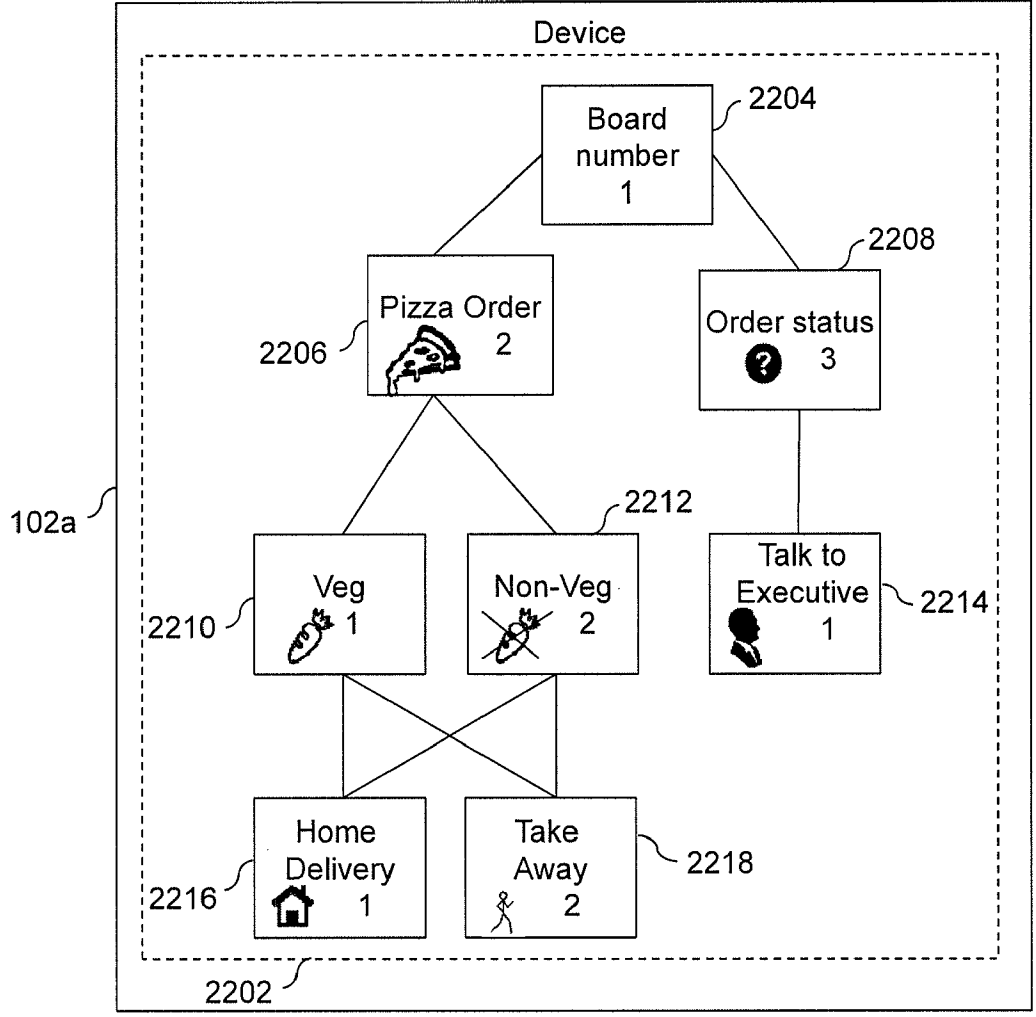

FIG.22

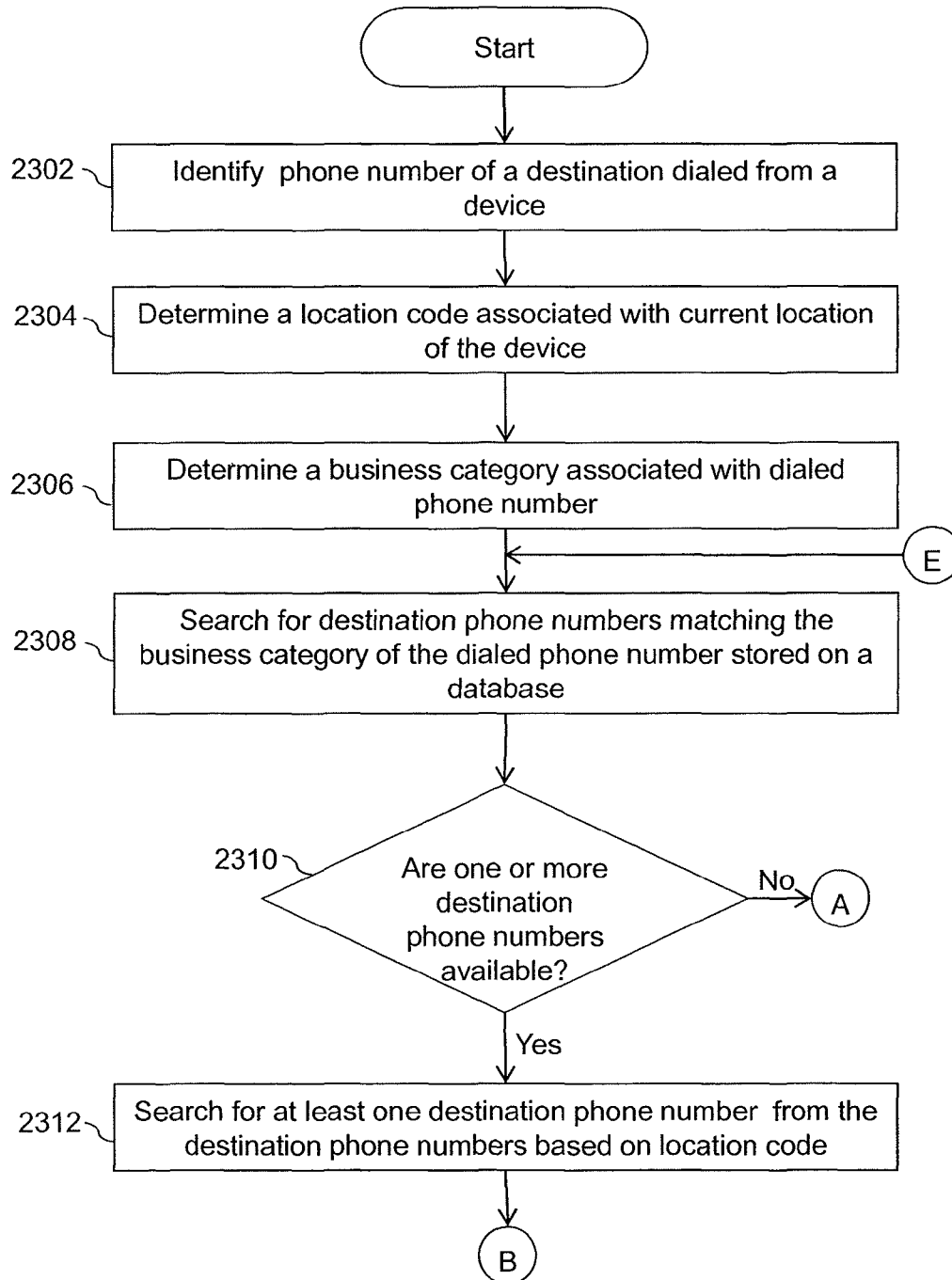

FIG. 23A

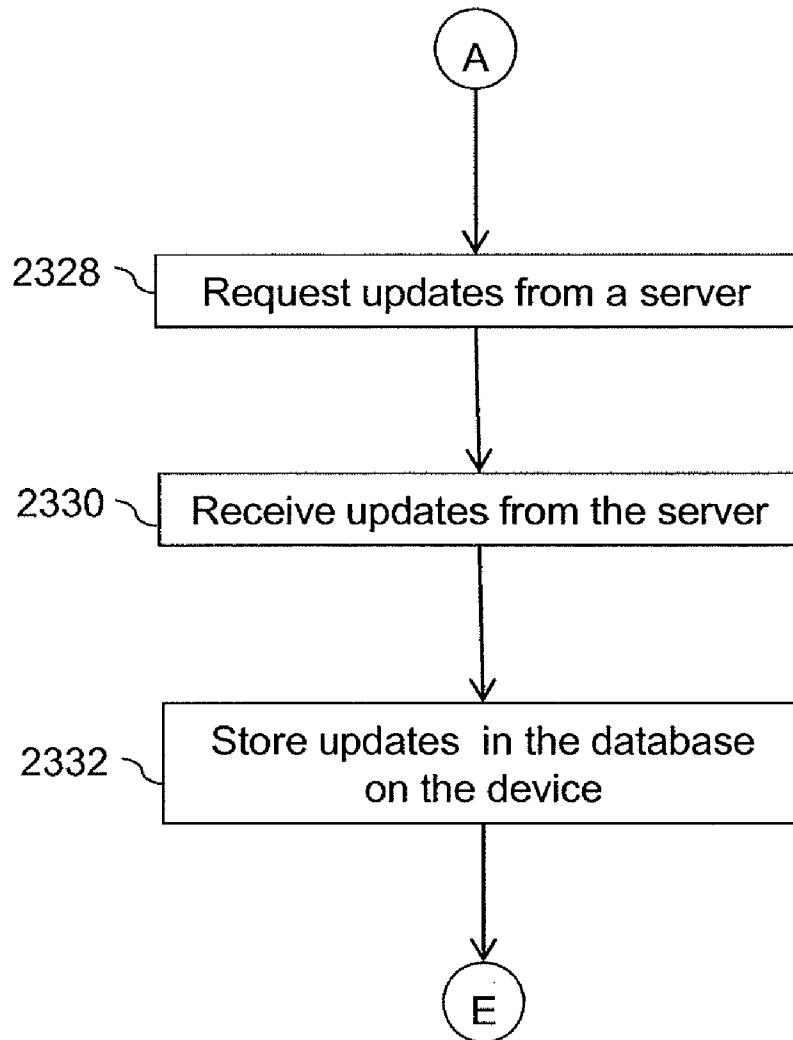

FIG. 23B

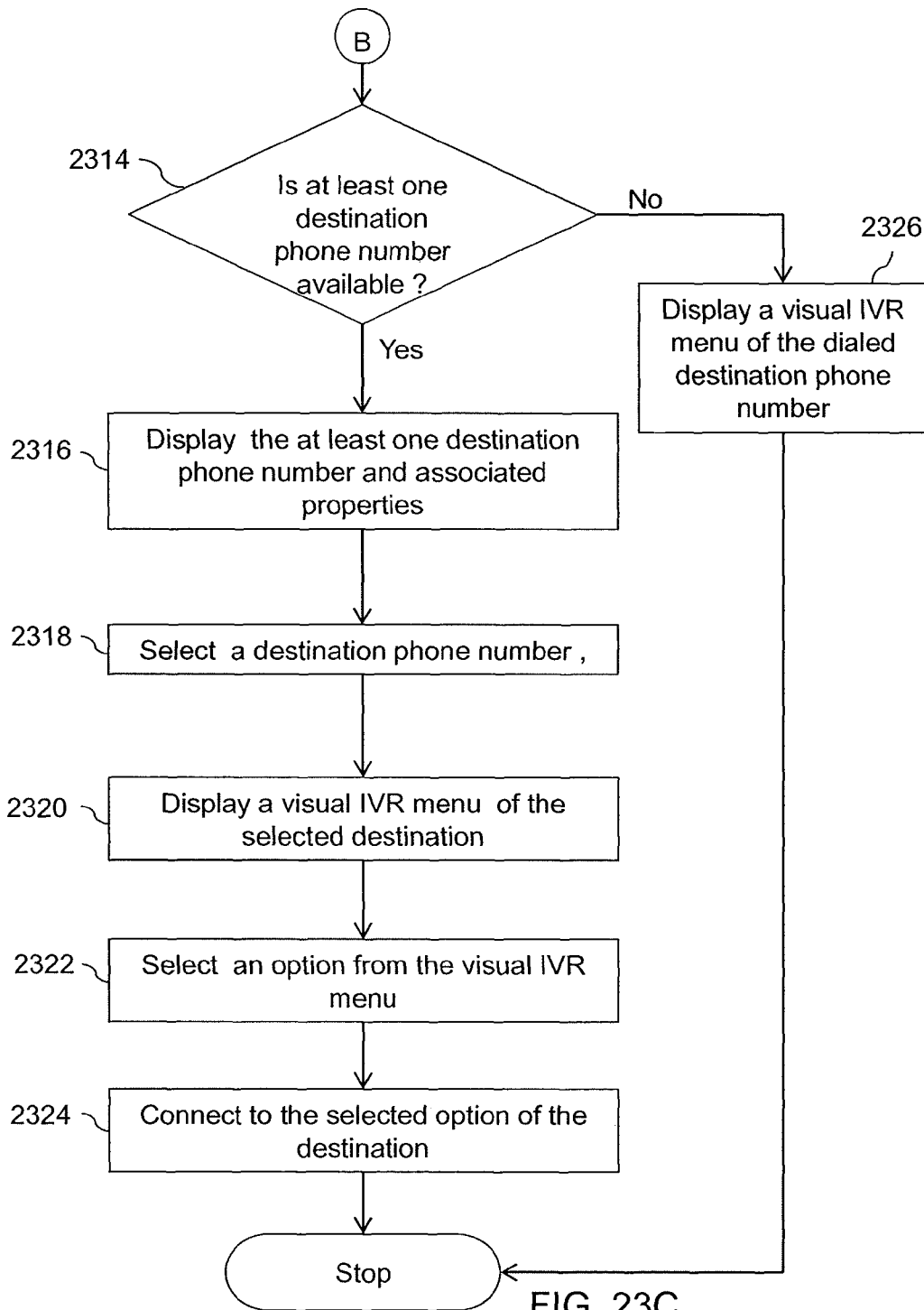

FIG. 23C

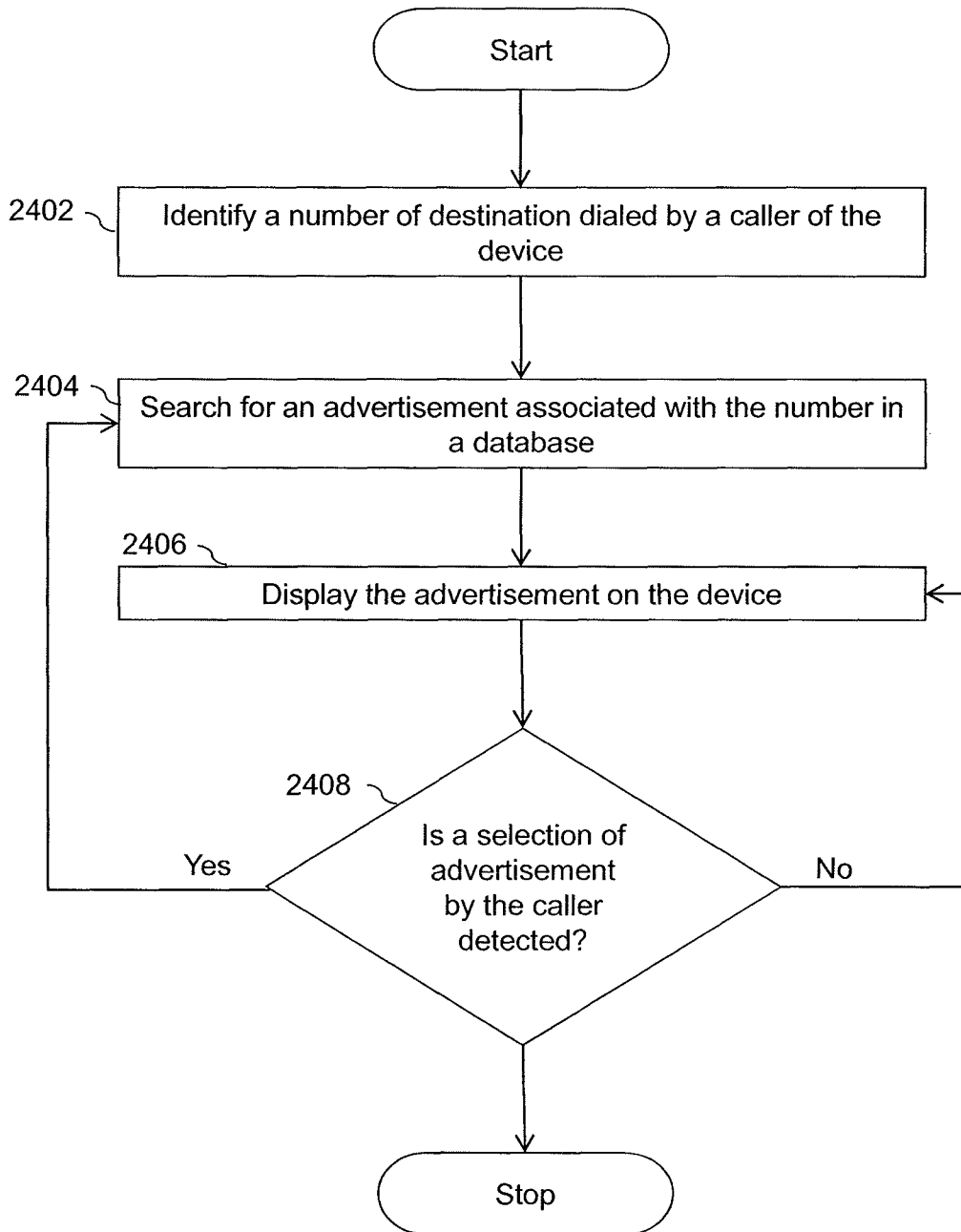

FIG. 24

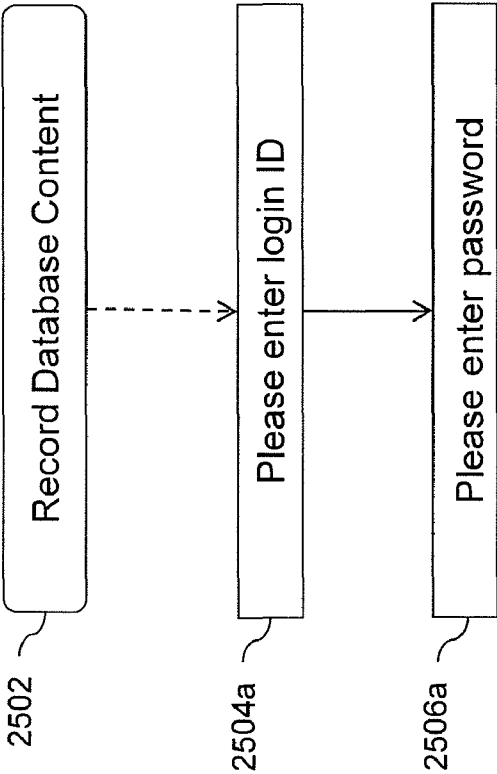

FIG.25A

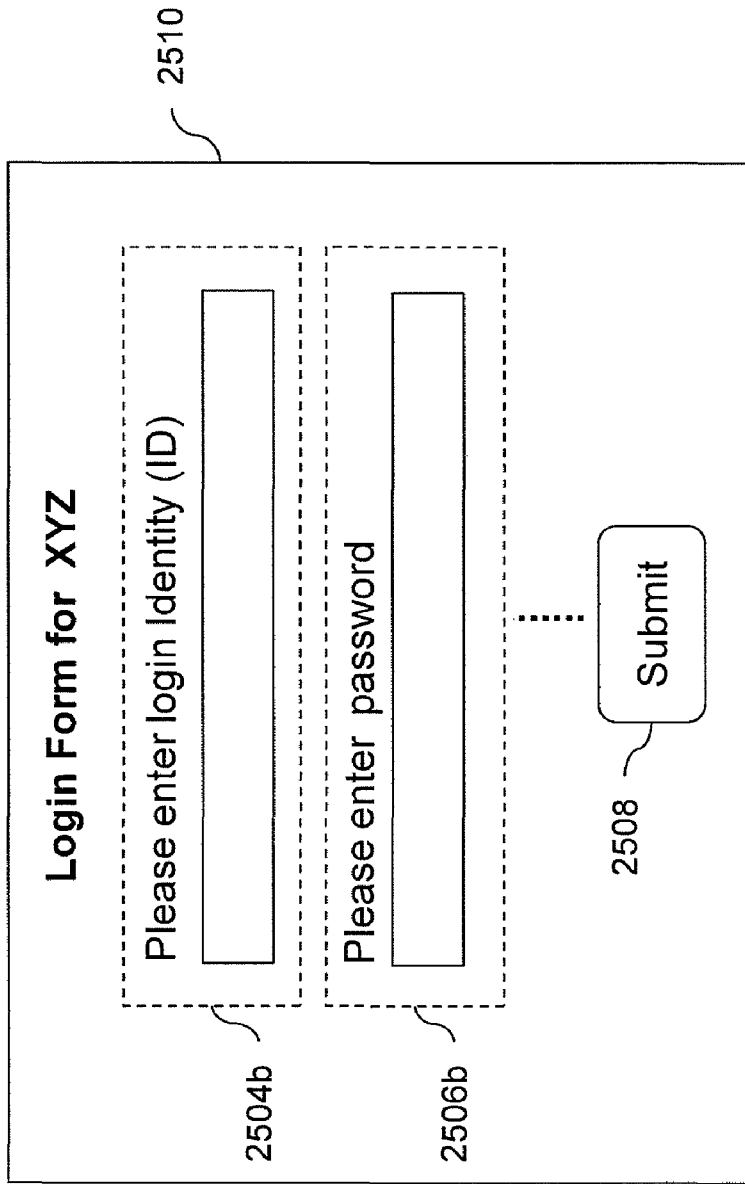

FIG.25B

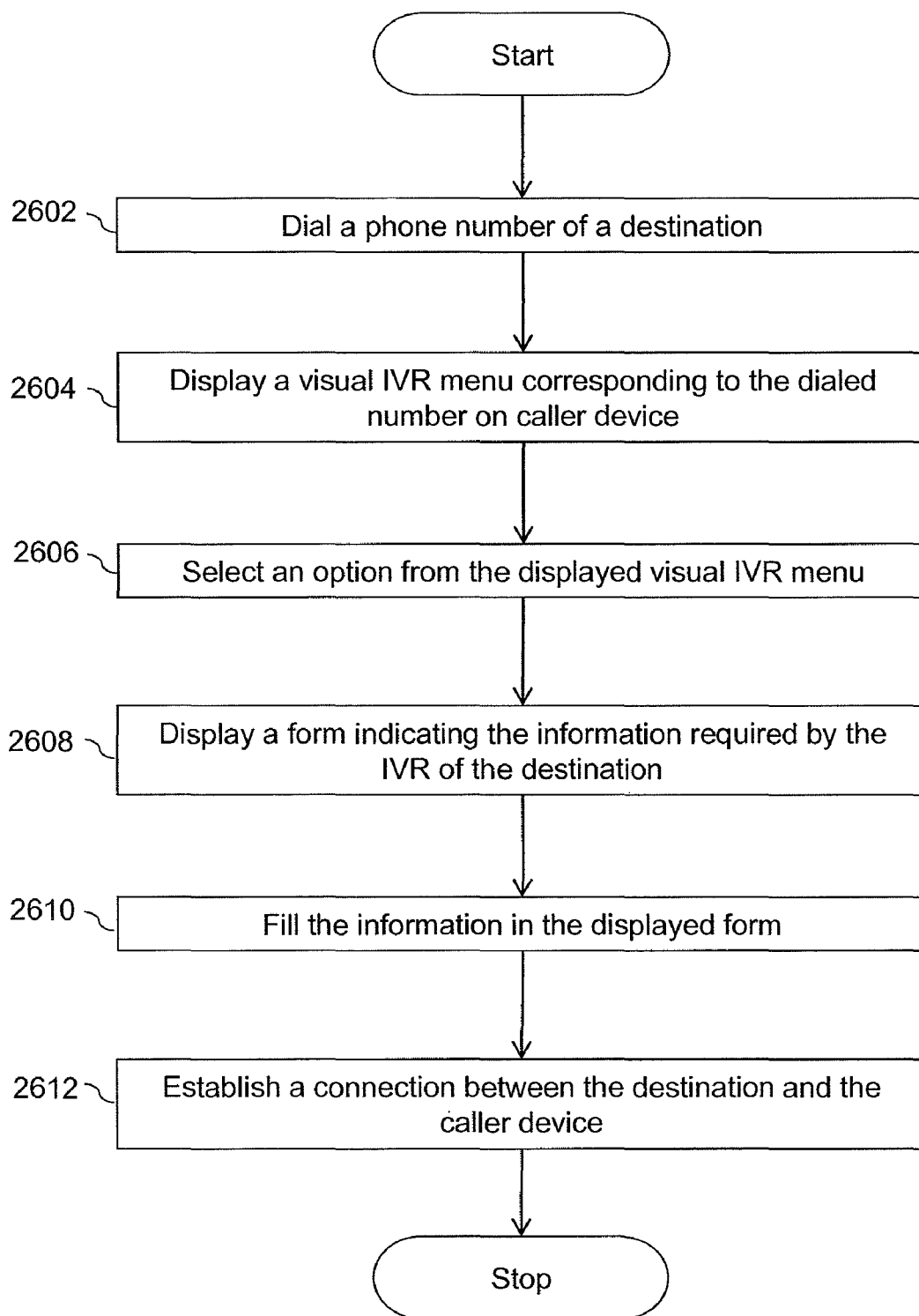

FIG. 26

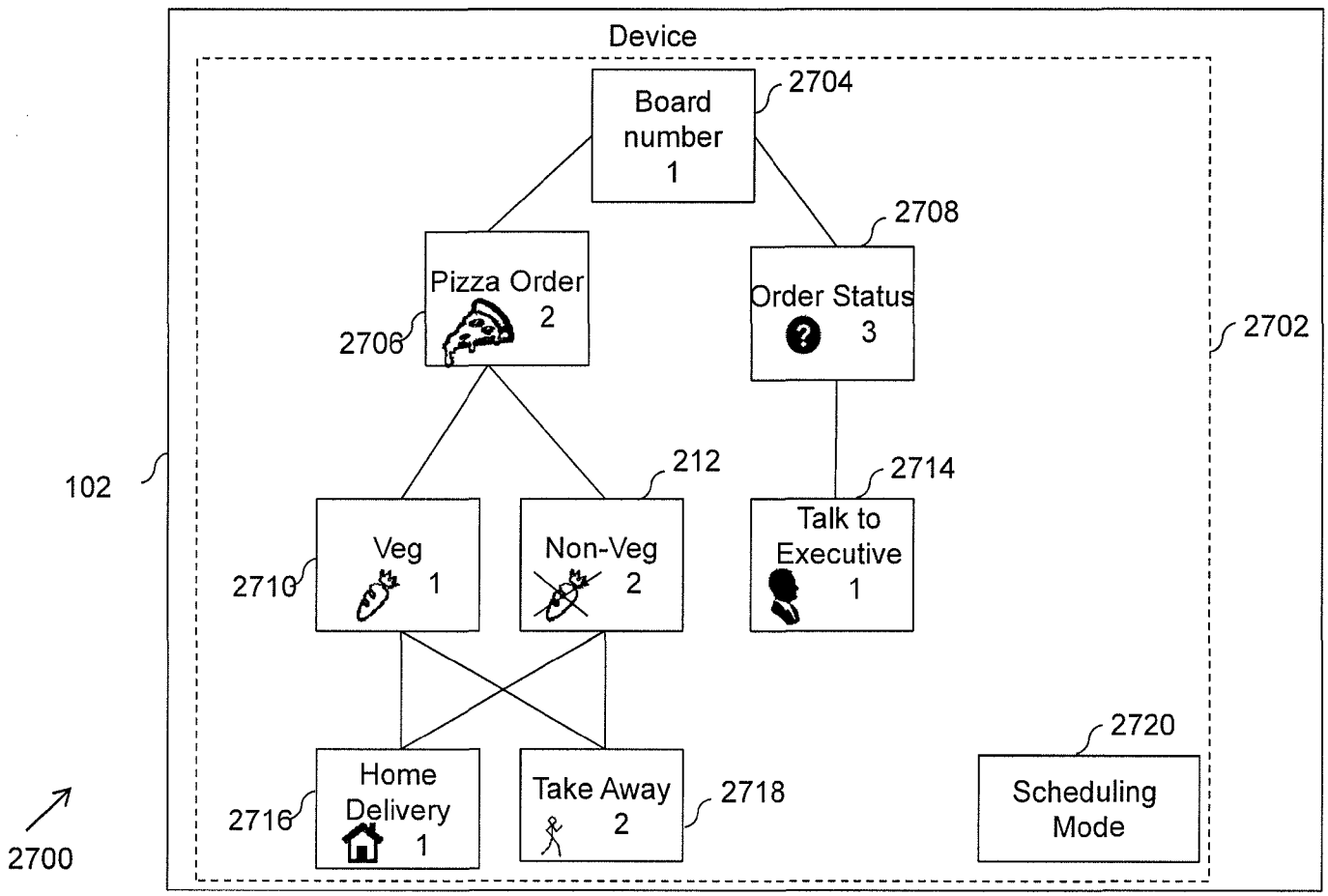

FIG. 27

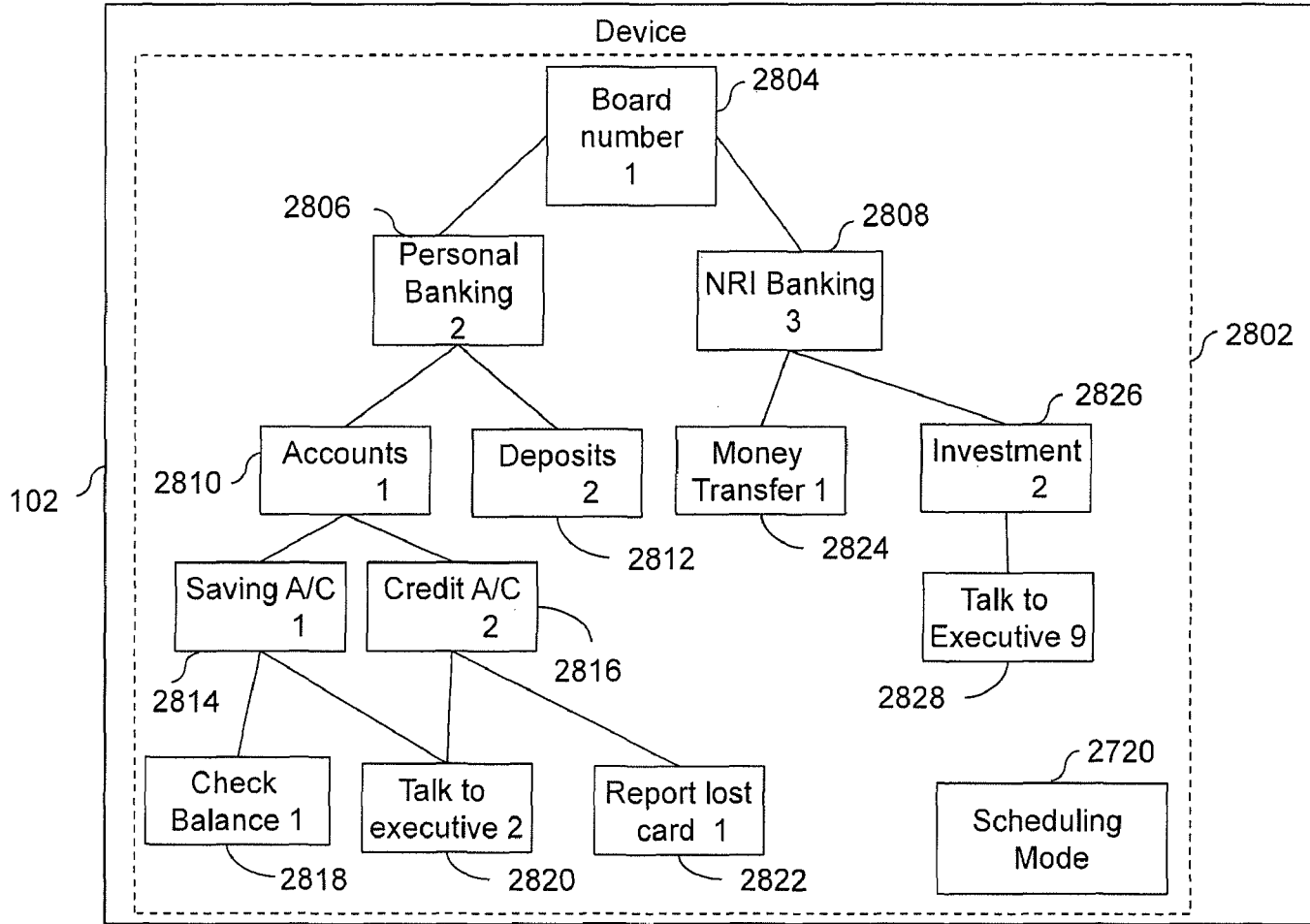

FIG. 28

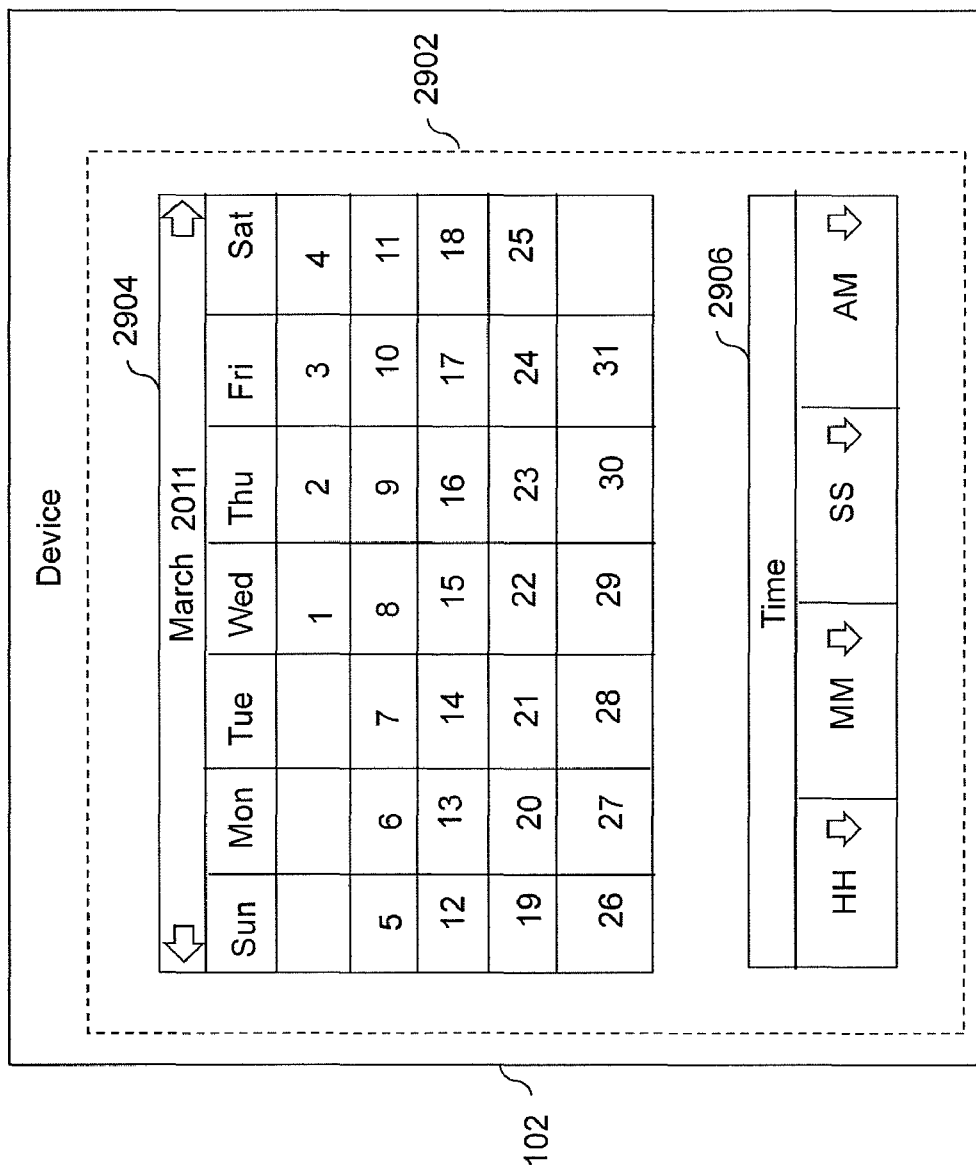

FIG. 29

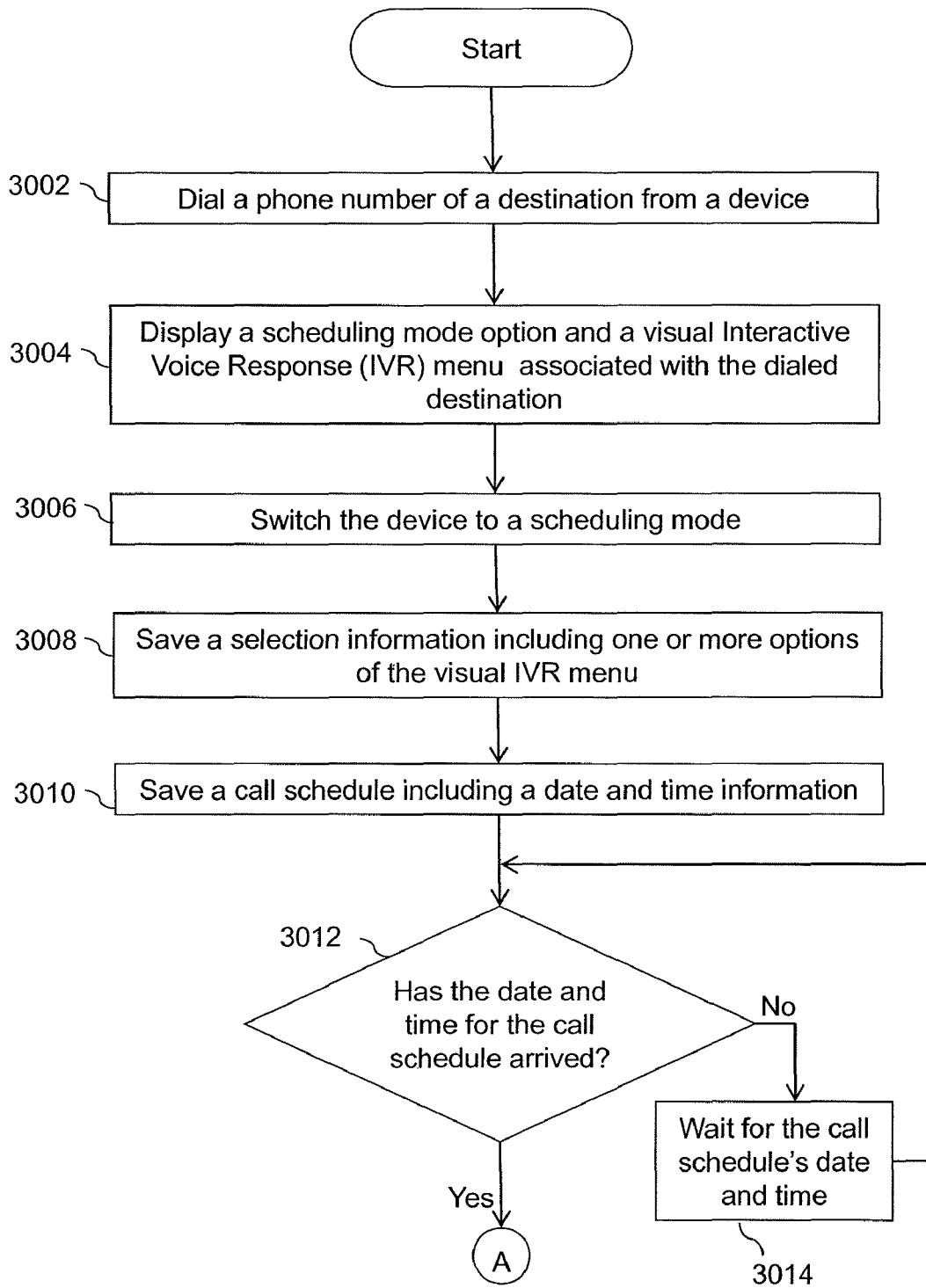

FIG. 30A

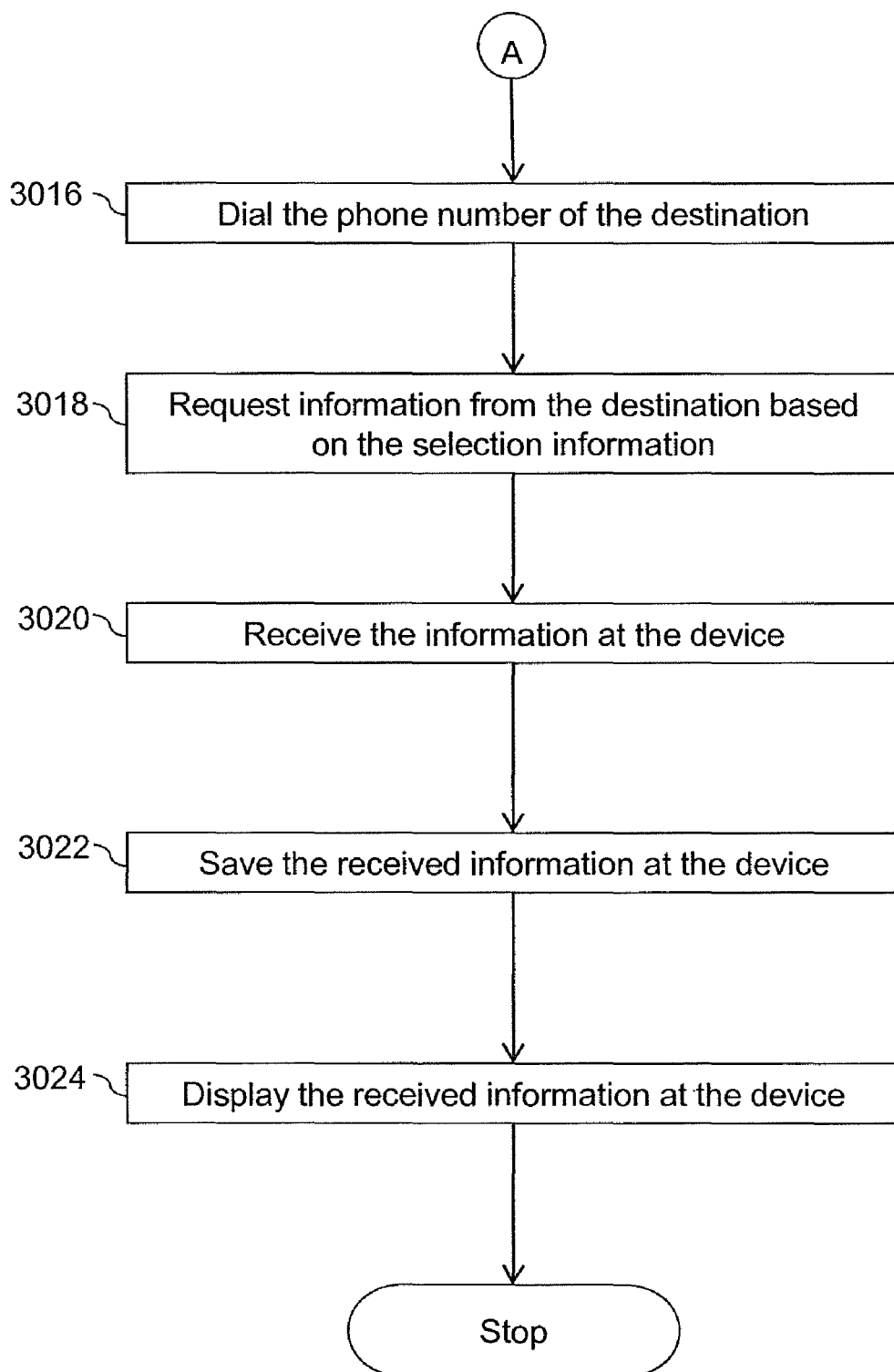

FIG. 30B

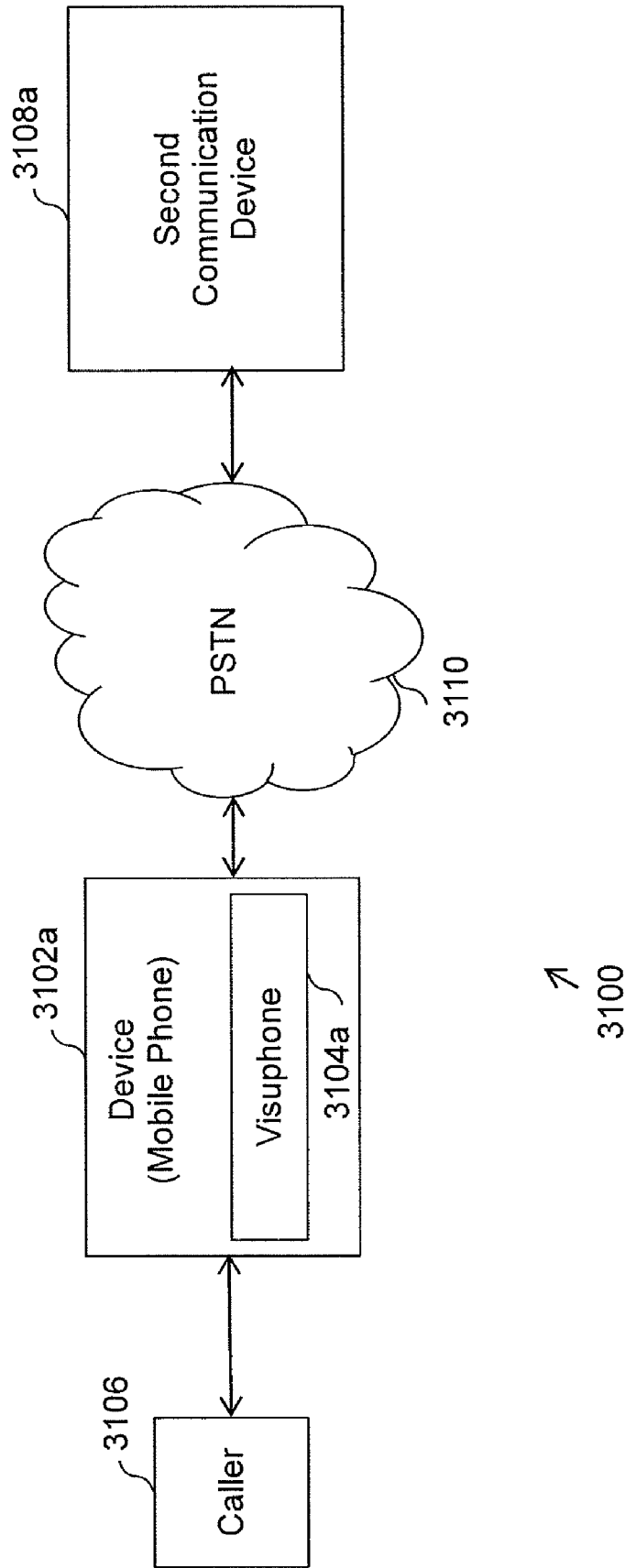

FIG. 31A

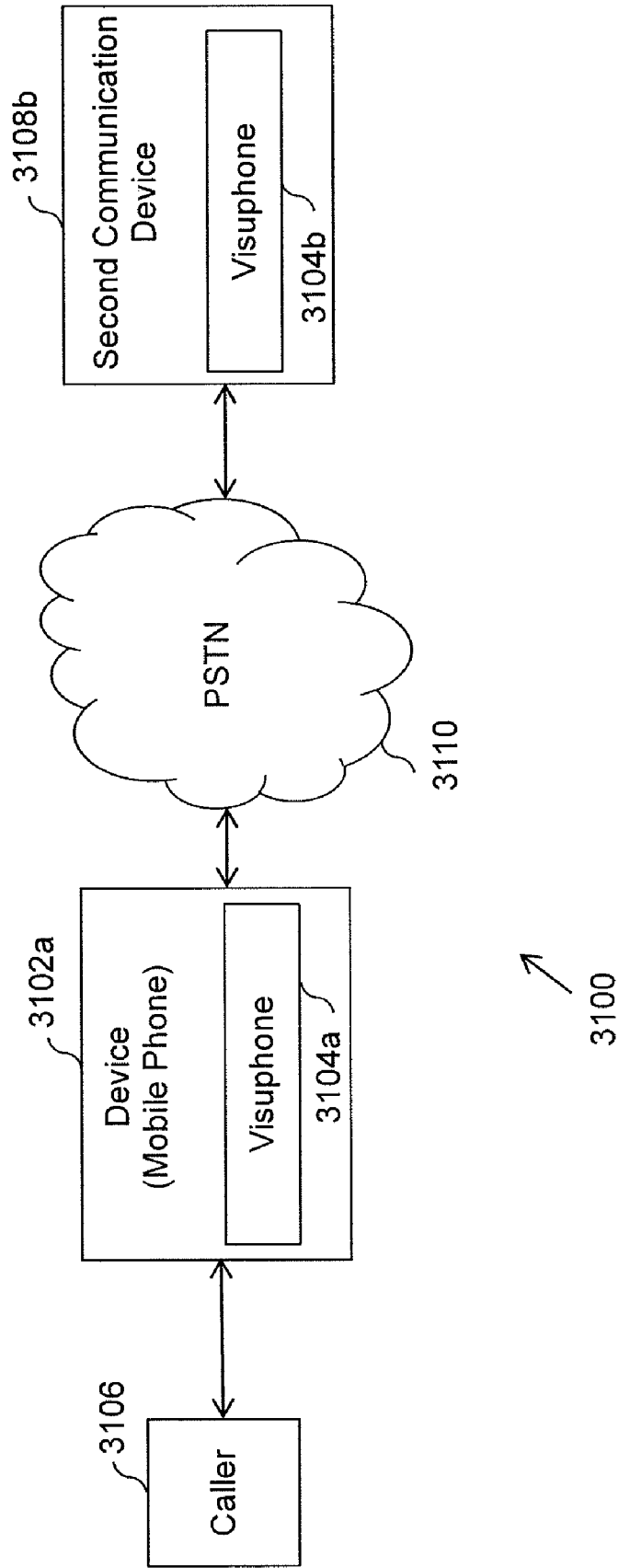

FIG. 31B

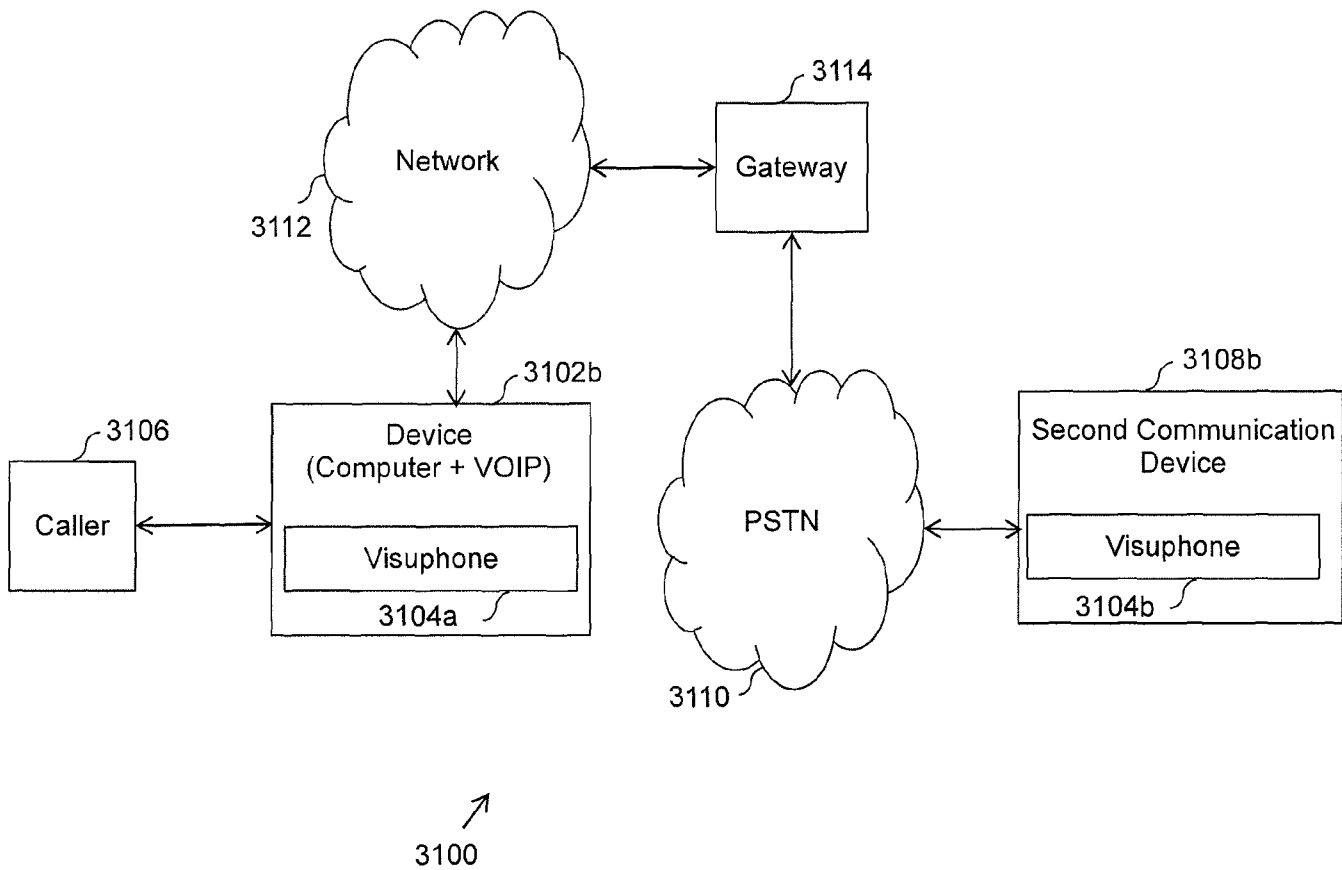

FIG. 31C

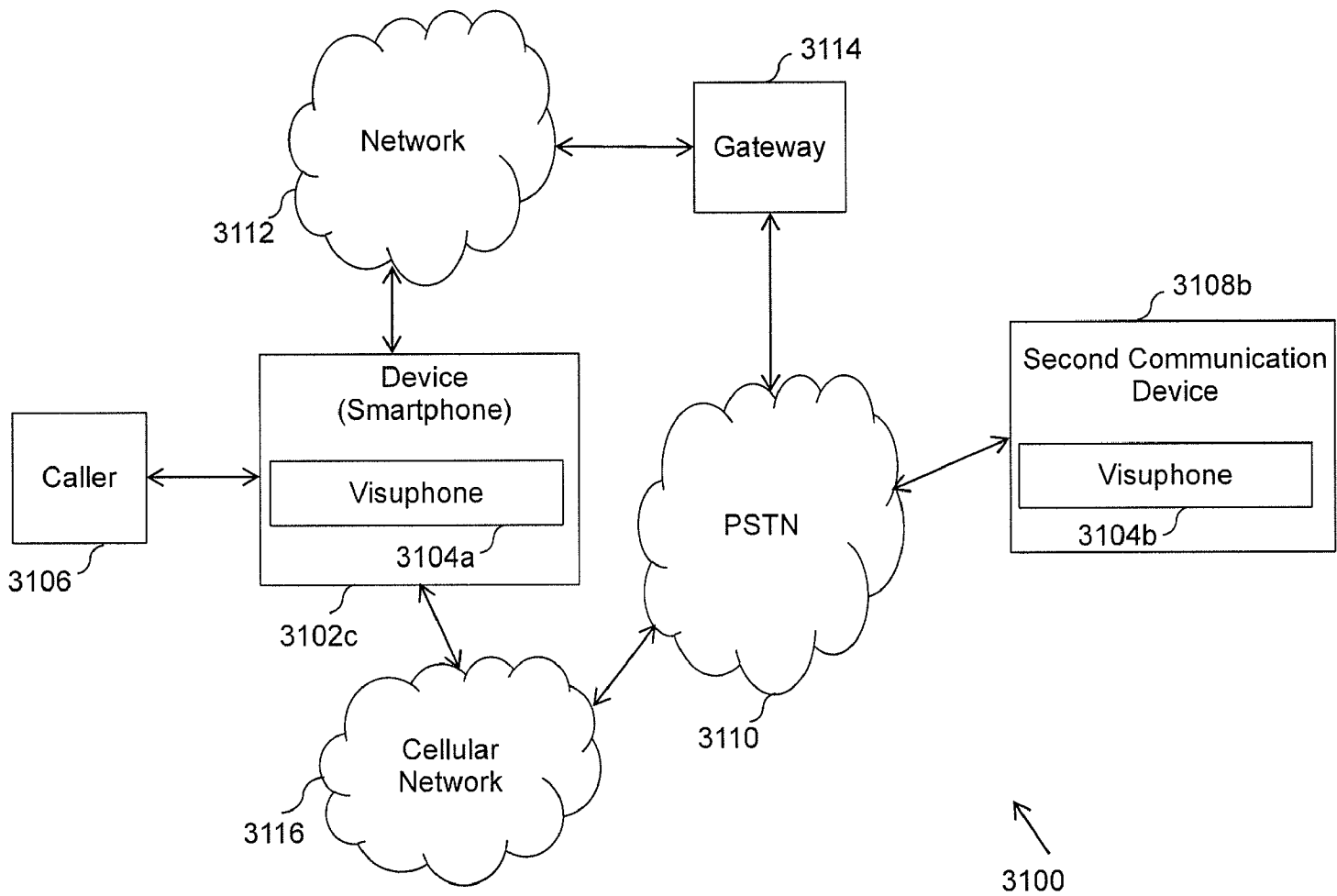

FIG. 31D

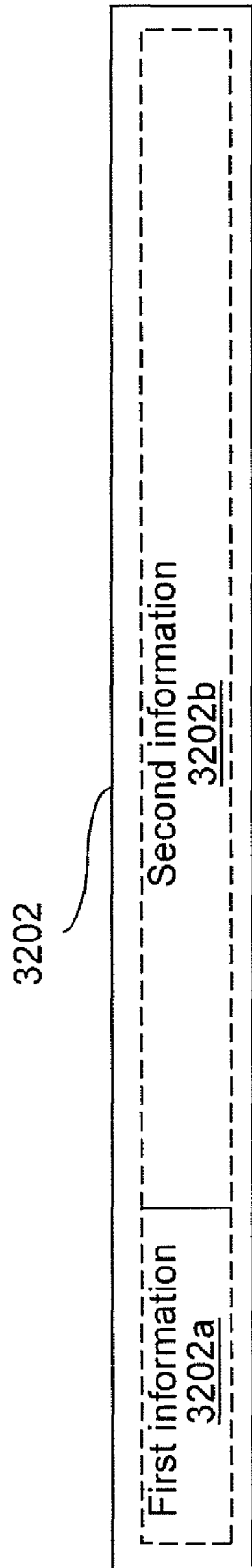

FIG. 32

Packet Version <u>3302</u>	Traffic Class <u>3304</u>	Flow Label <u>3306</u>	
Payload Length <u>3308</u>	Next Header <u>3310</u>		Hop Limit <u>3312</u>
Source Address <u>3314</u>			
Destination Address <u>3316</u>			

3202a

FIG. 33

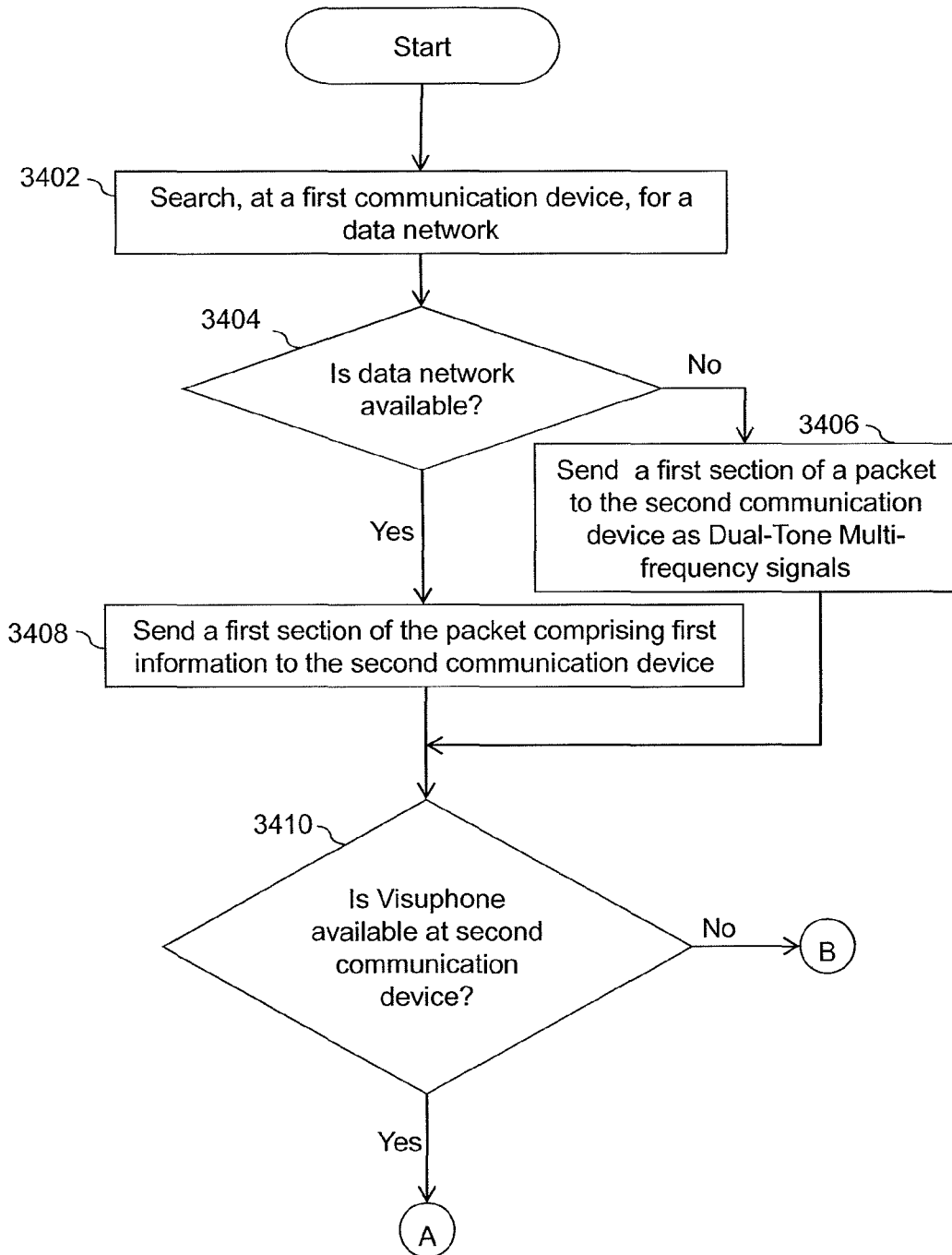

FIG. 34A

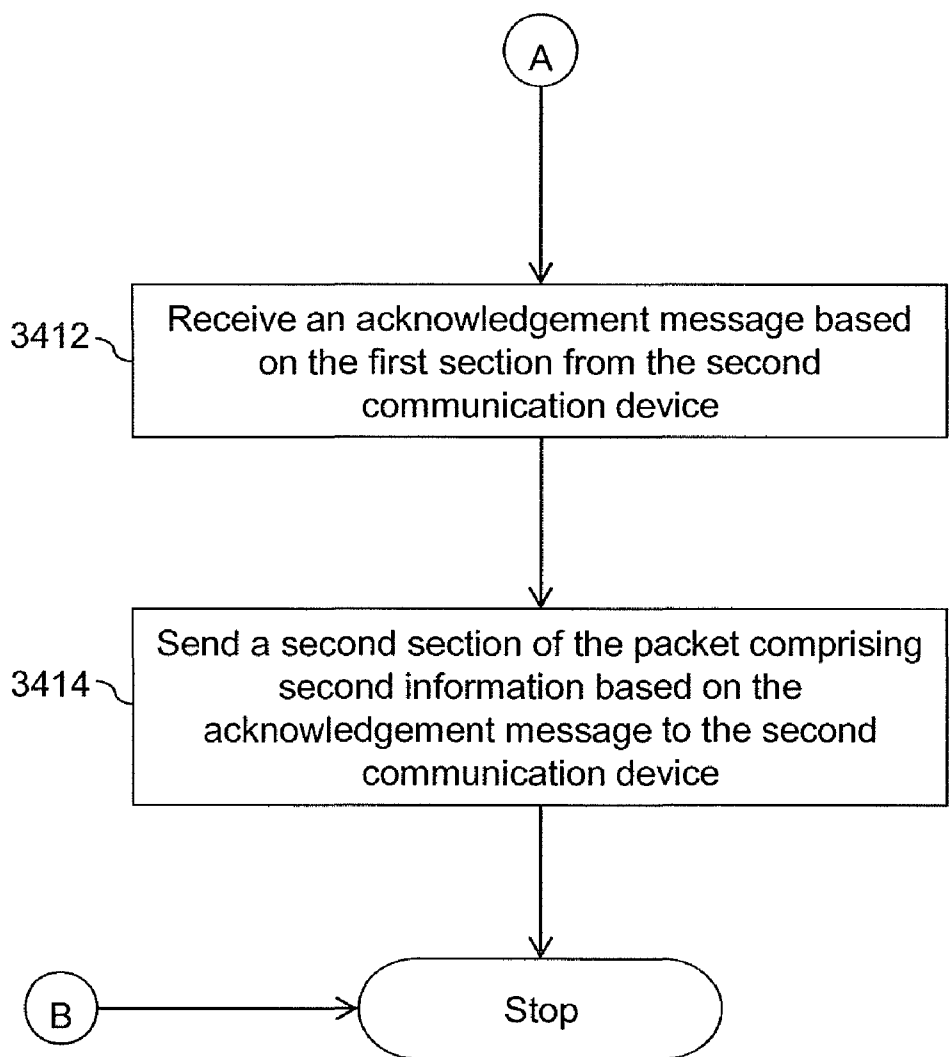

FIG. 34B

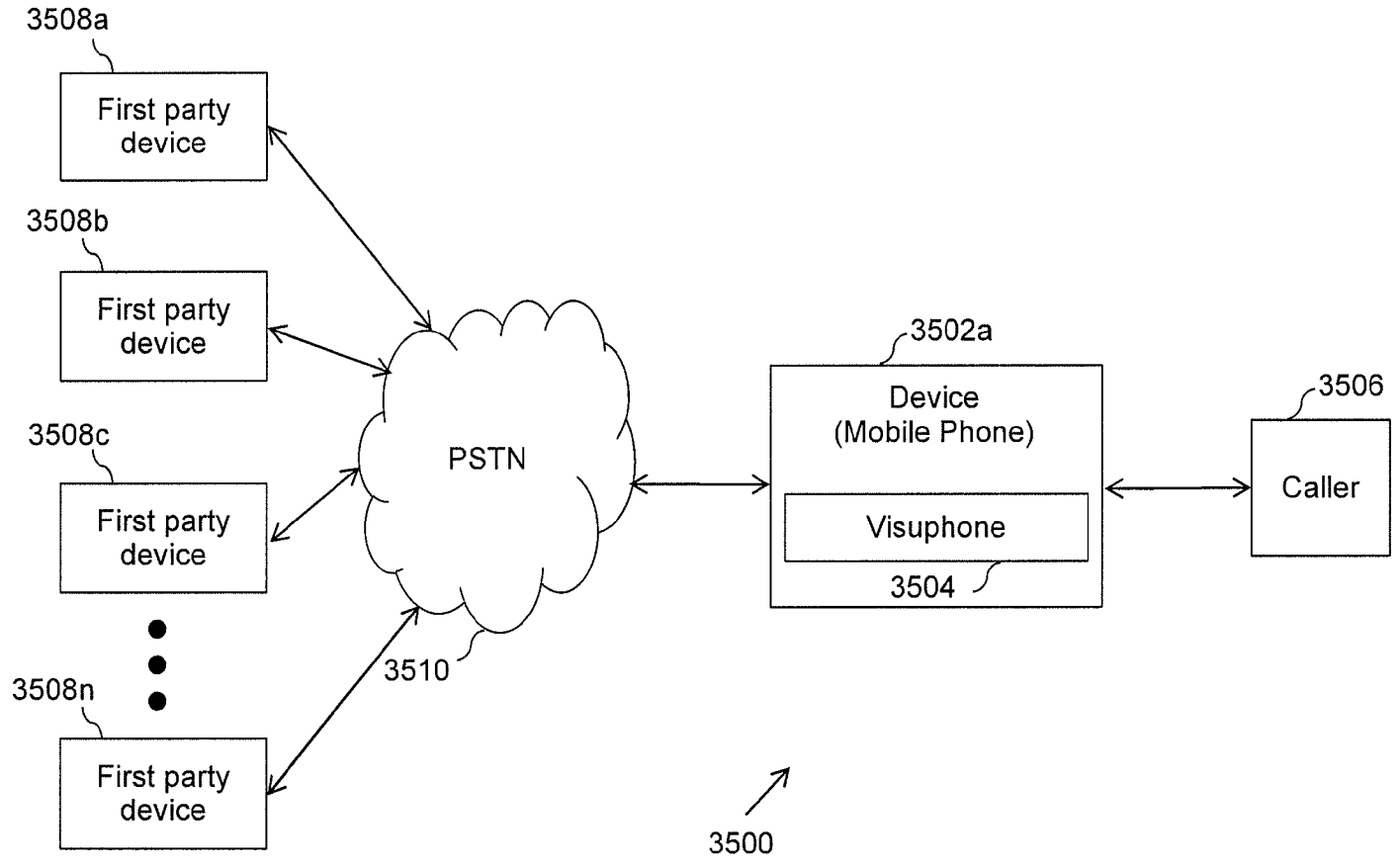

FIG. 35A

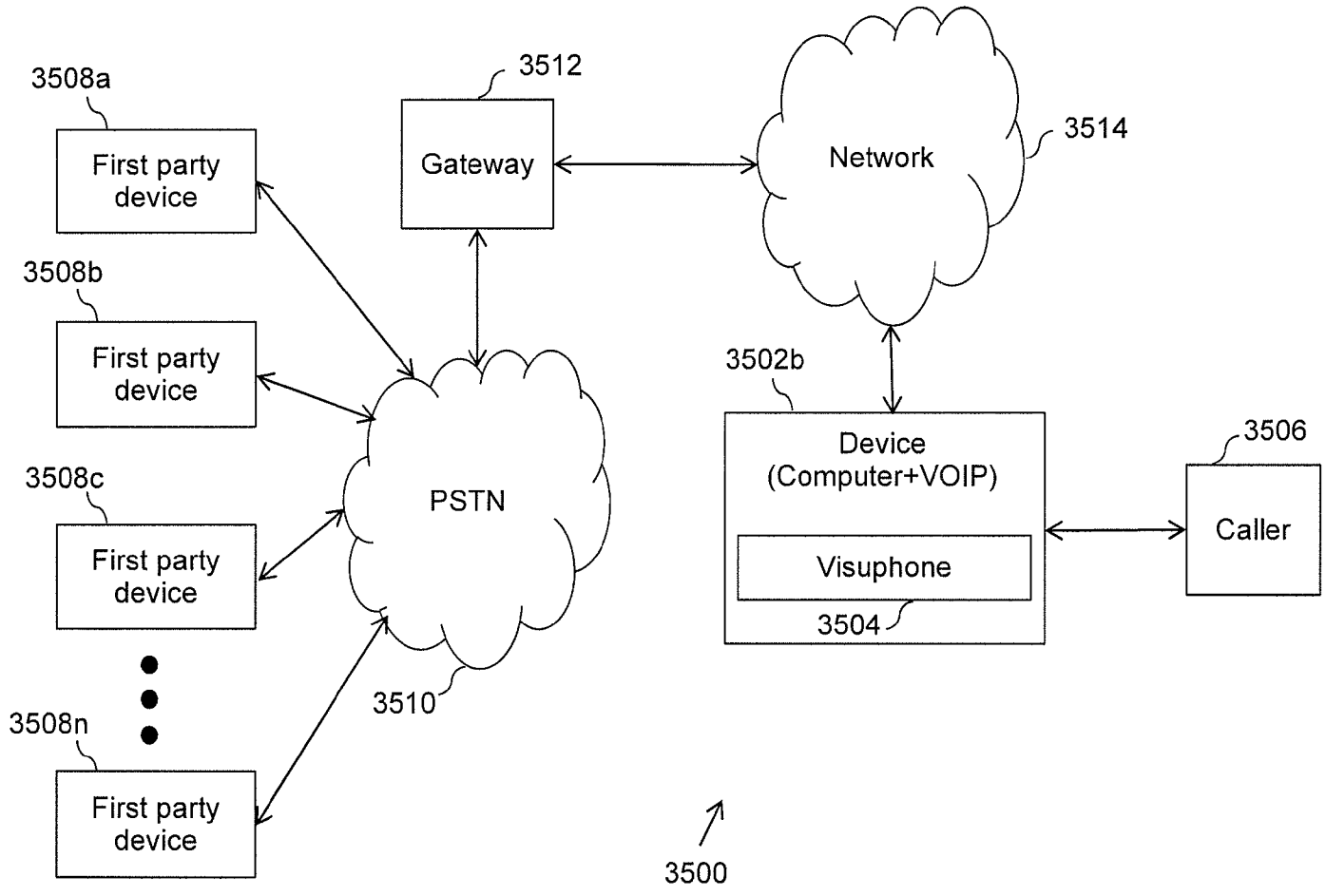

FIG. 35B

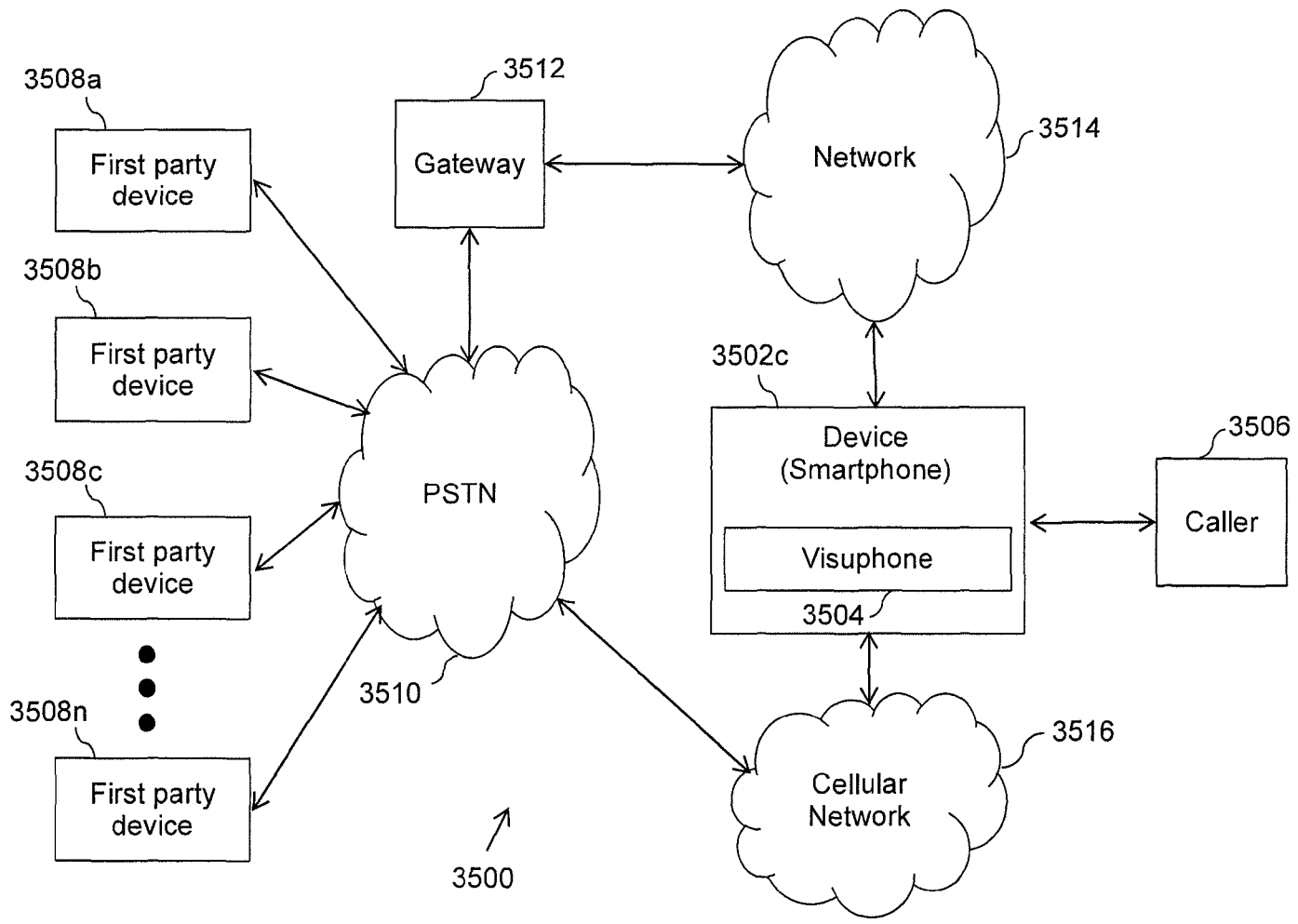

FIG. 35C

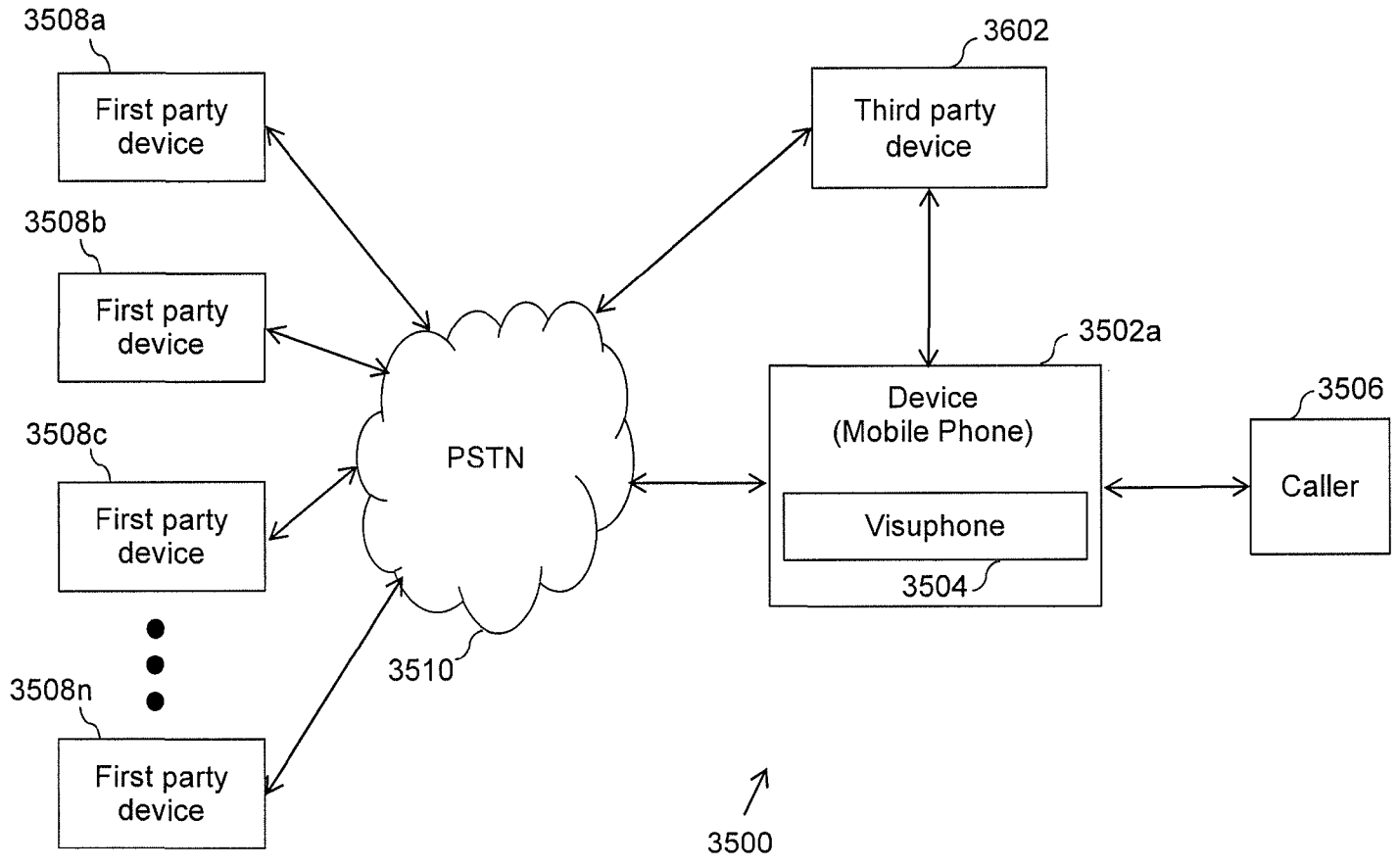

FIG. 36

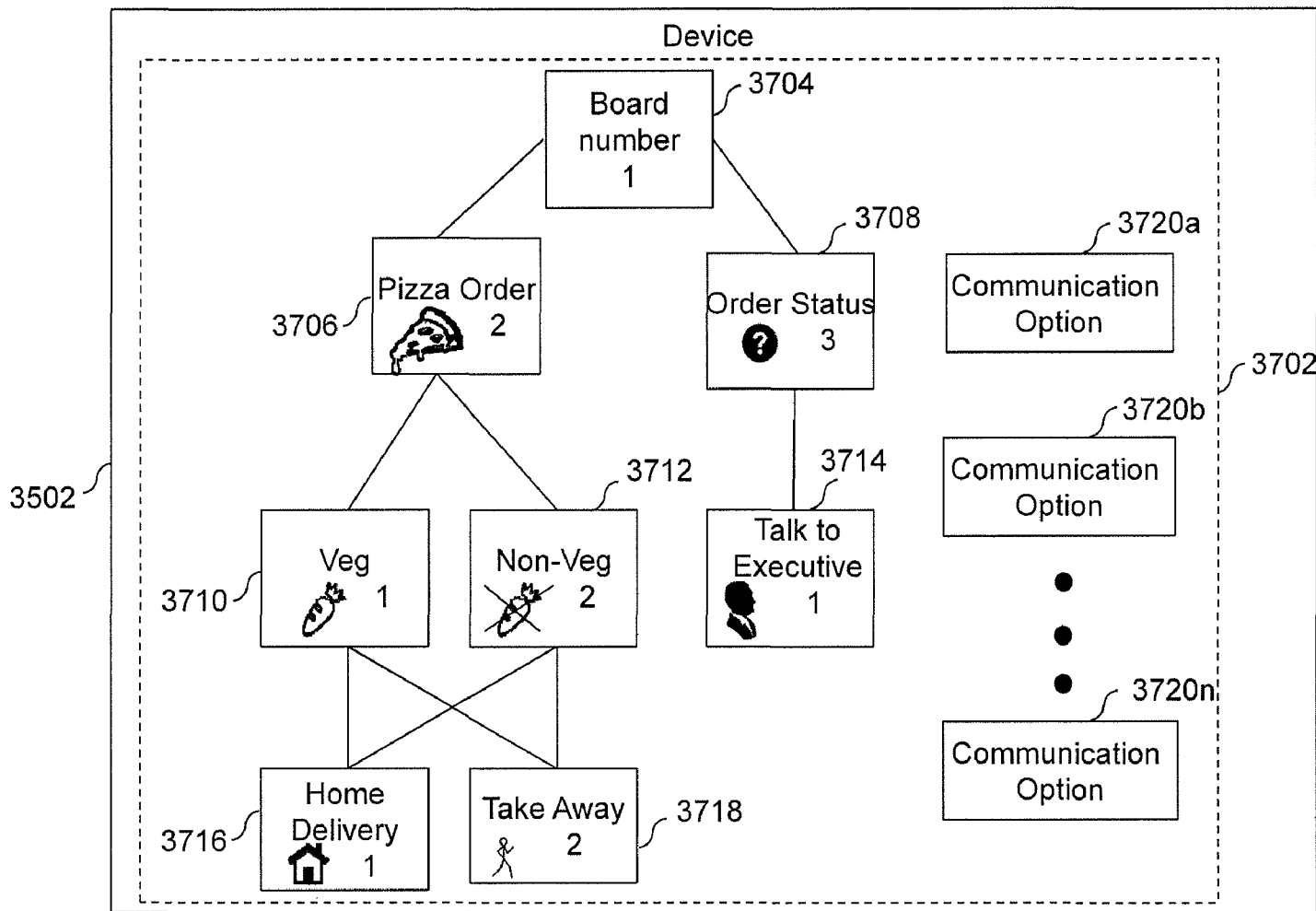

FIG. 37

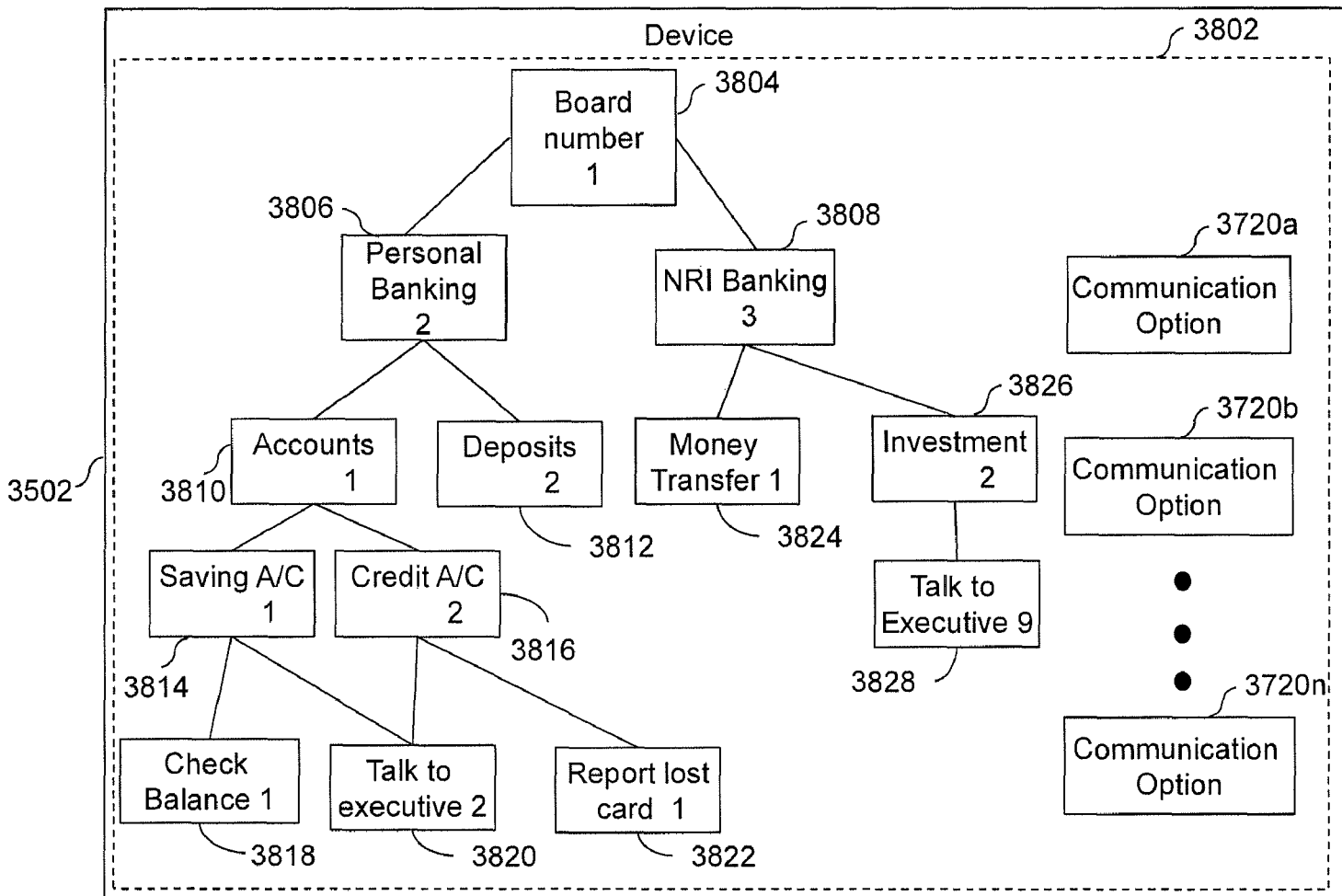

FIG. 38

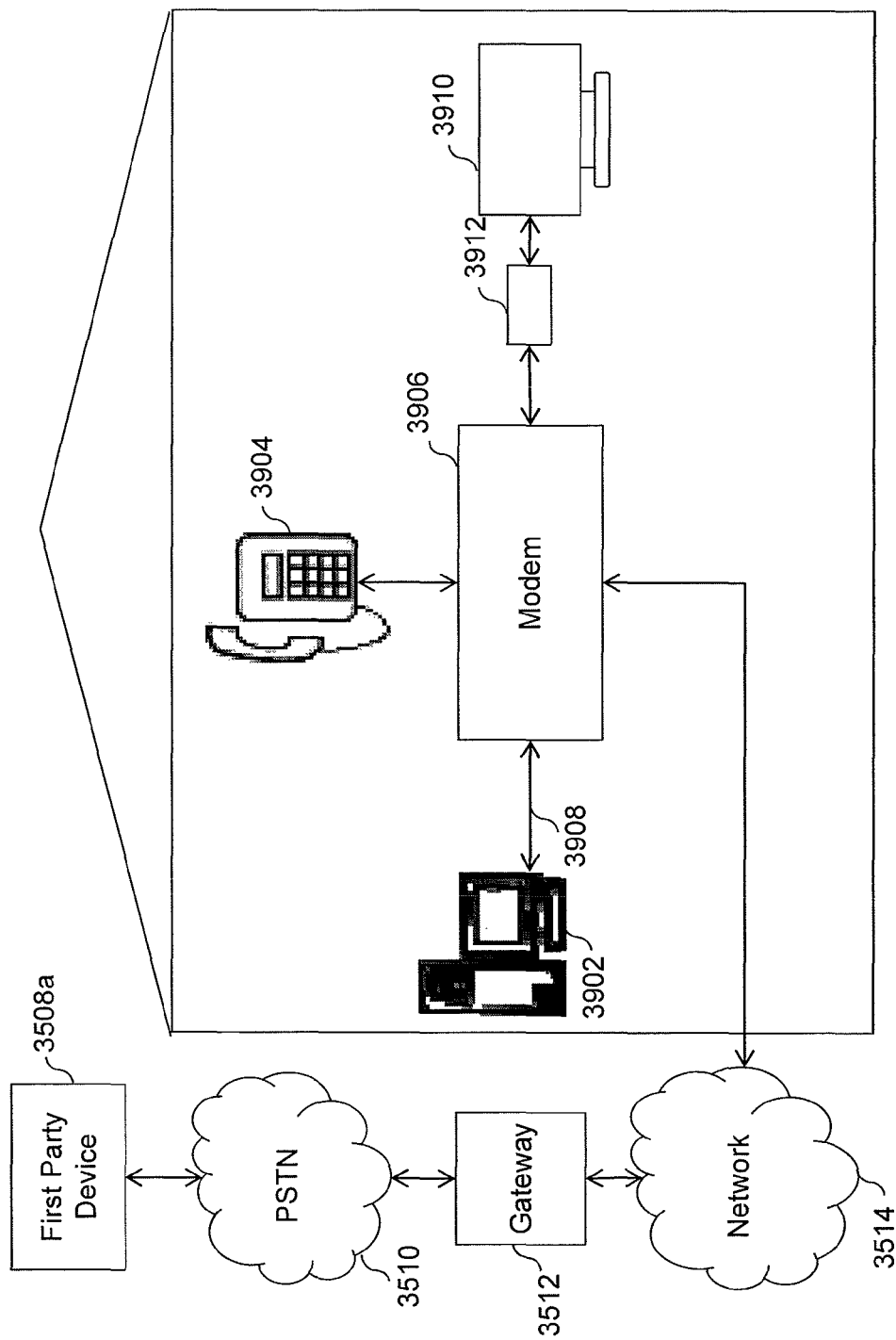

FIG. 39

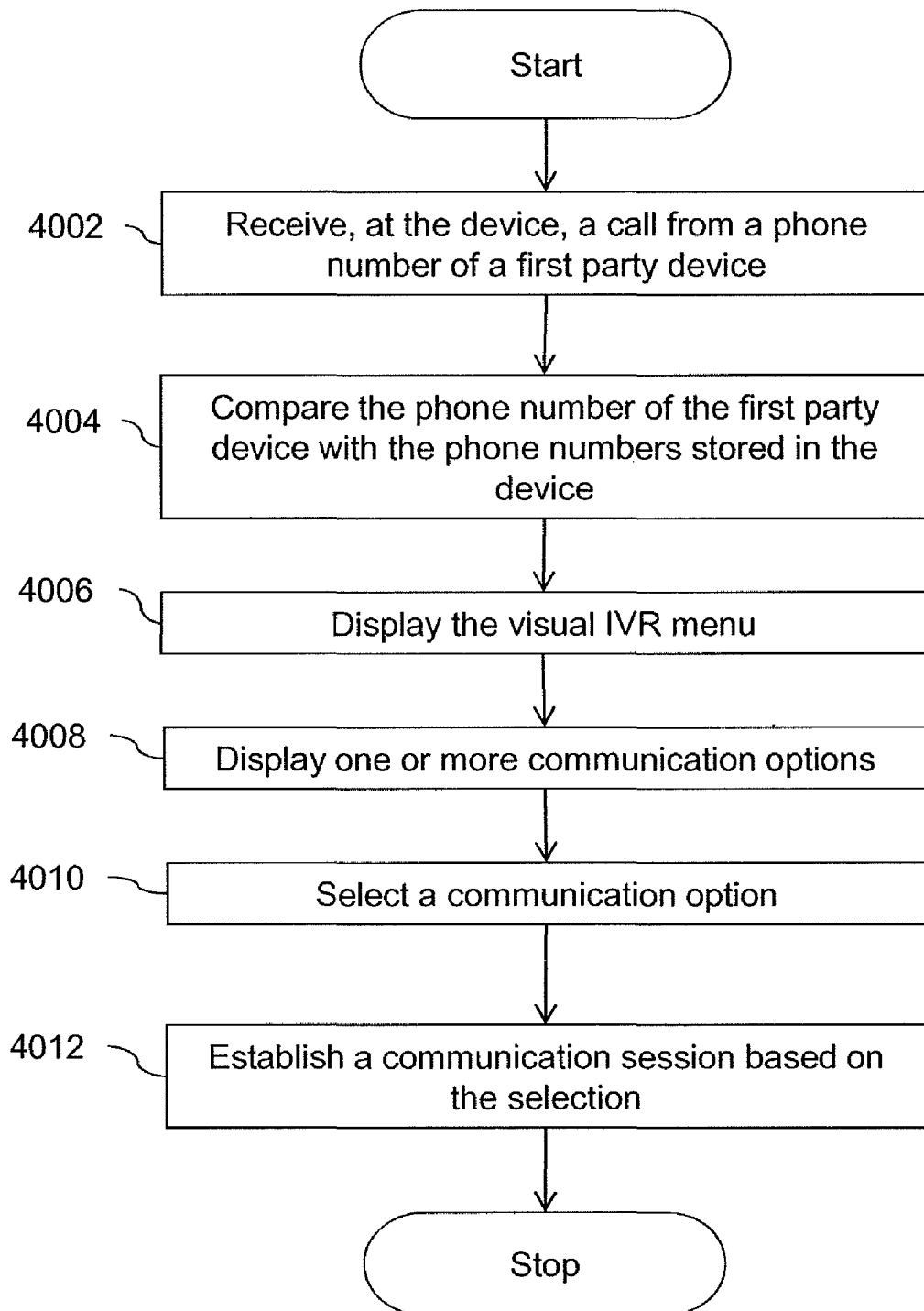

FIG. 40

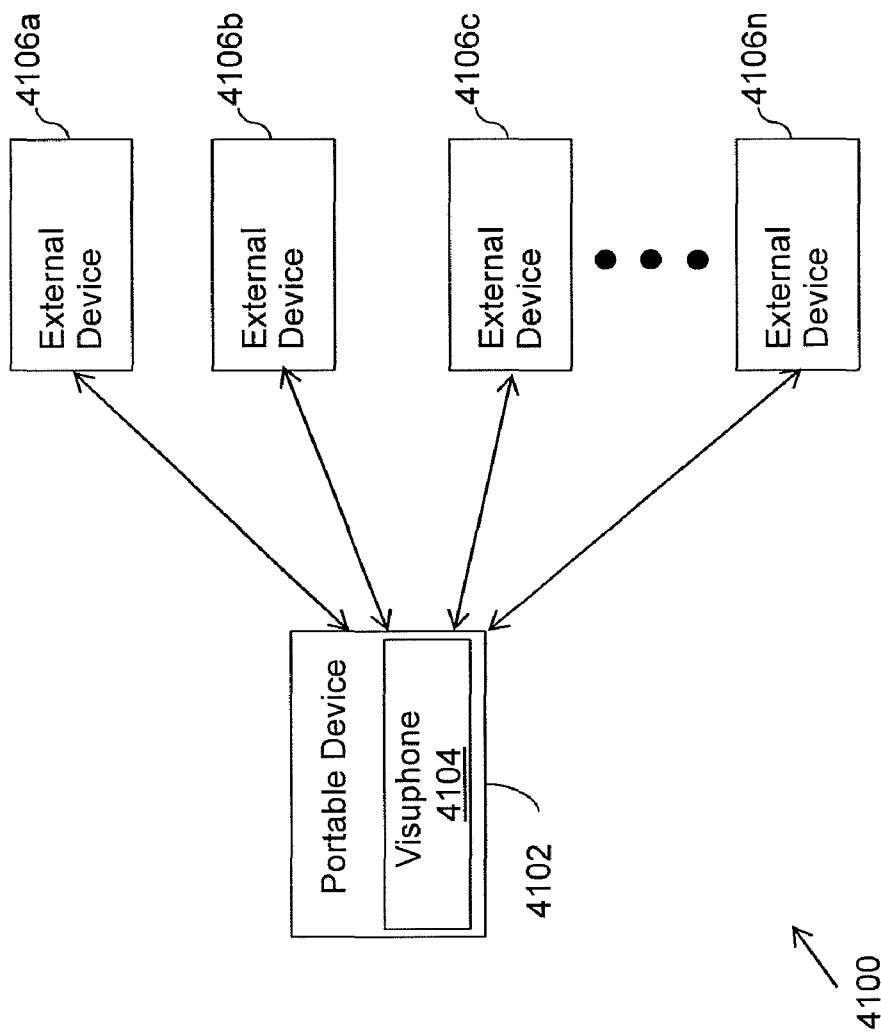

FIG. 41

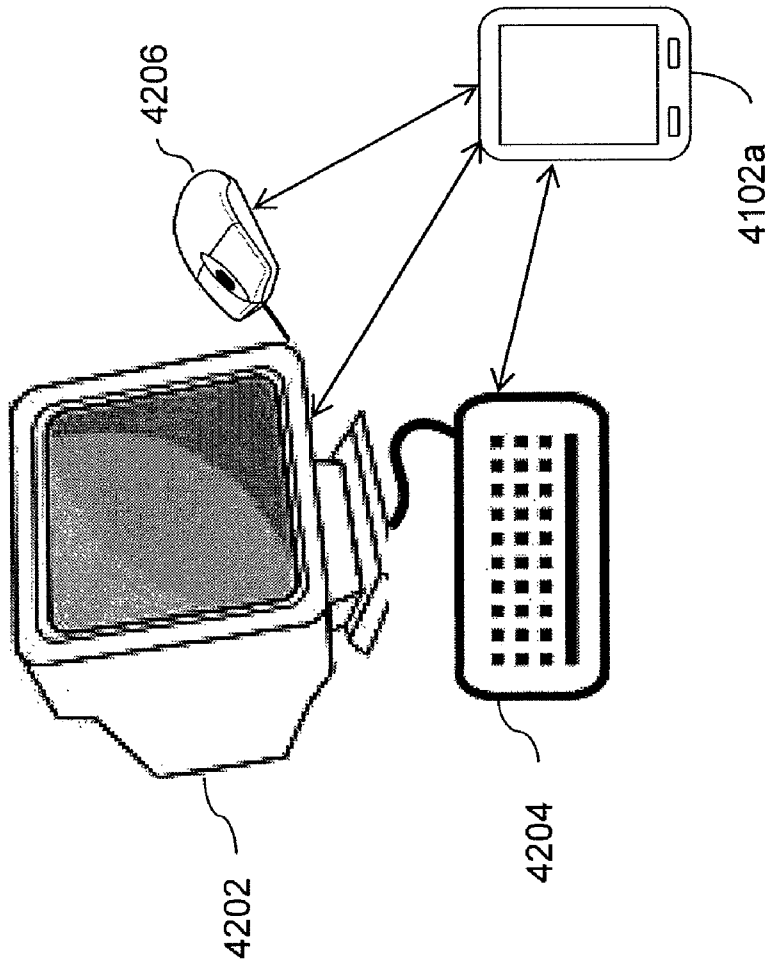

FIG. 42

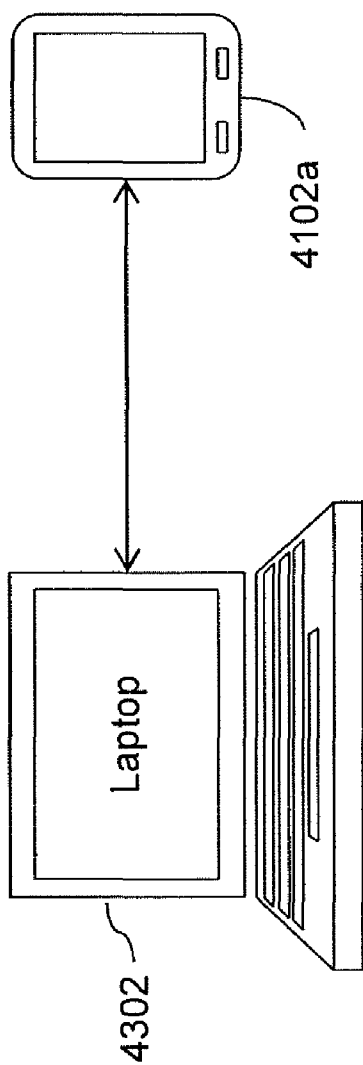

FIG. 43

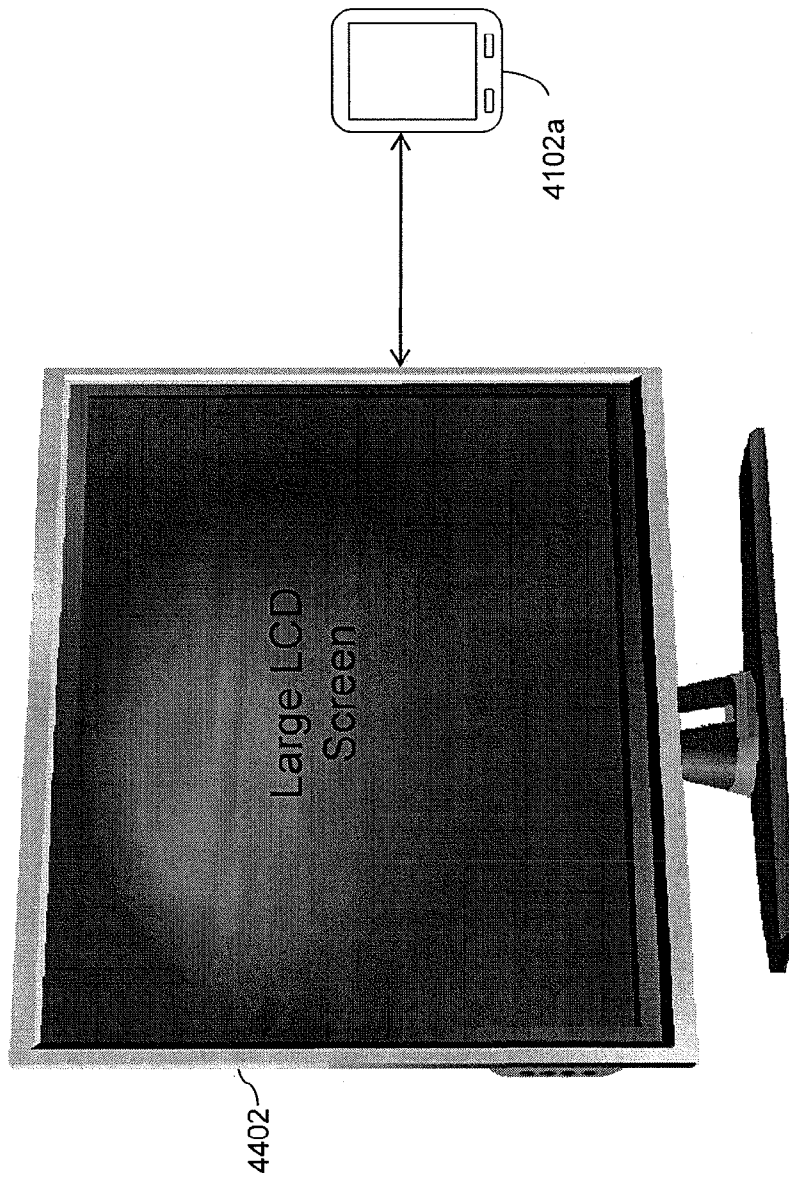

FIG. 44

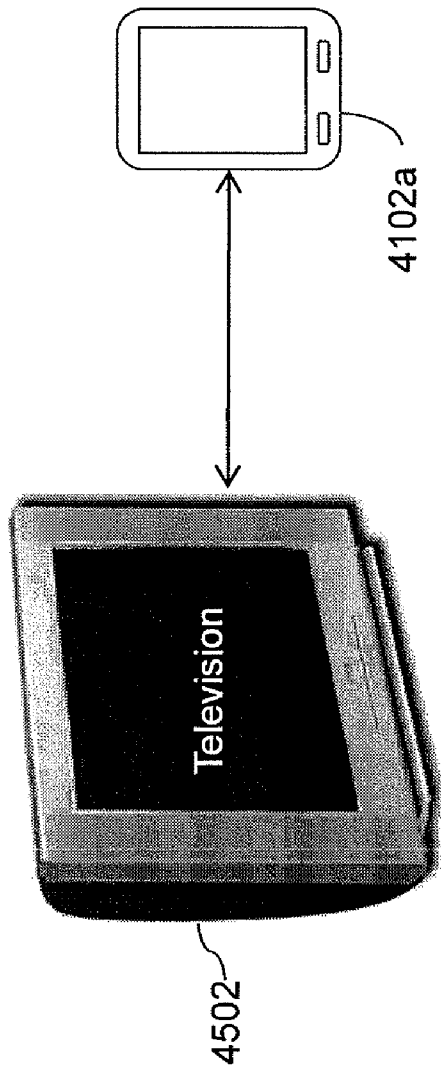

FIG. 45

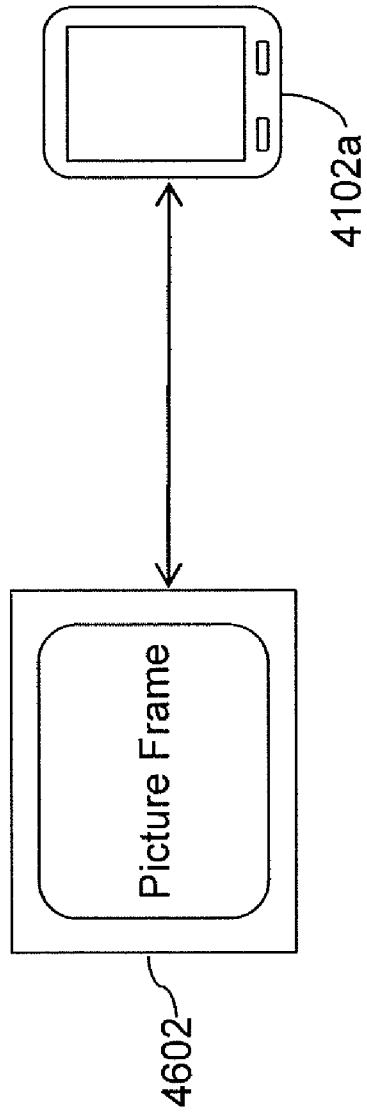

FIG. 46

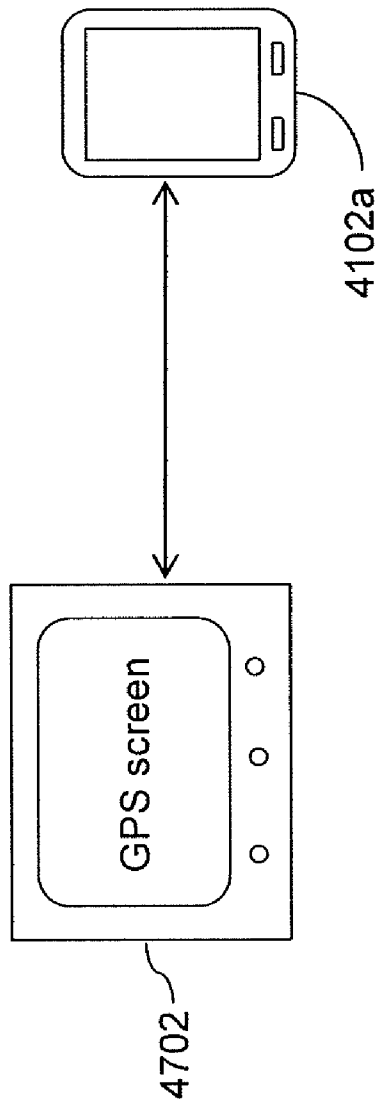

FIG. 47

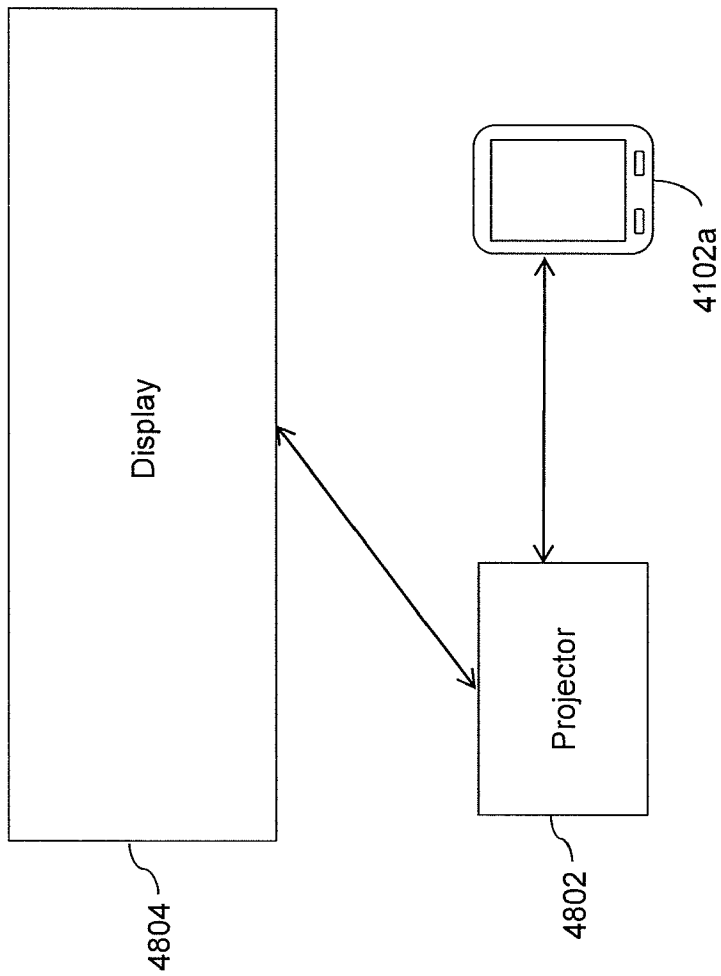

FIG. 48

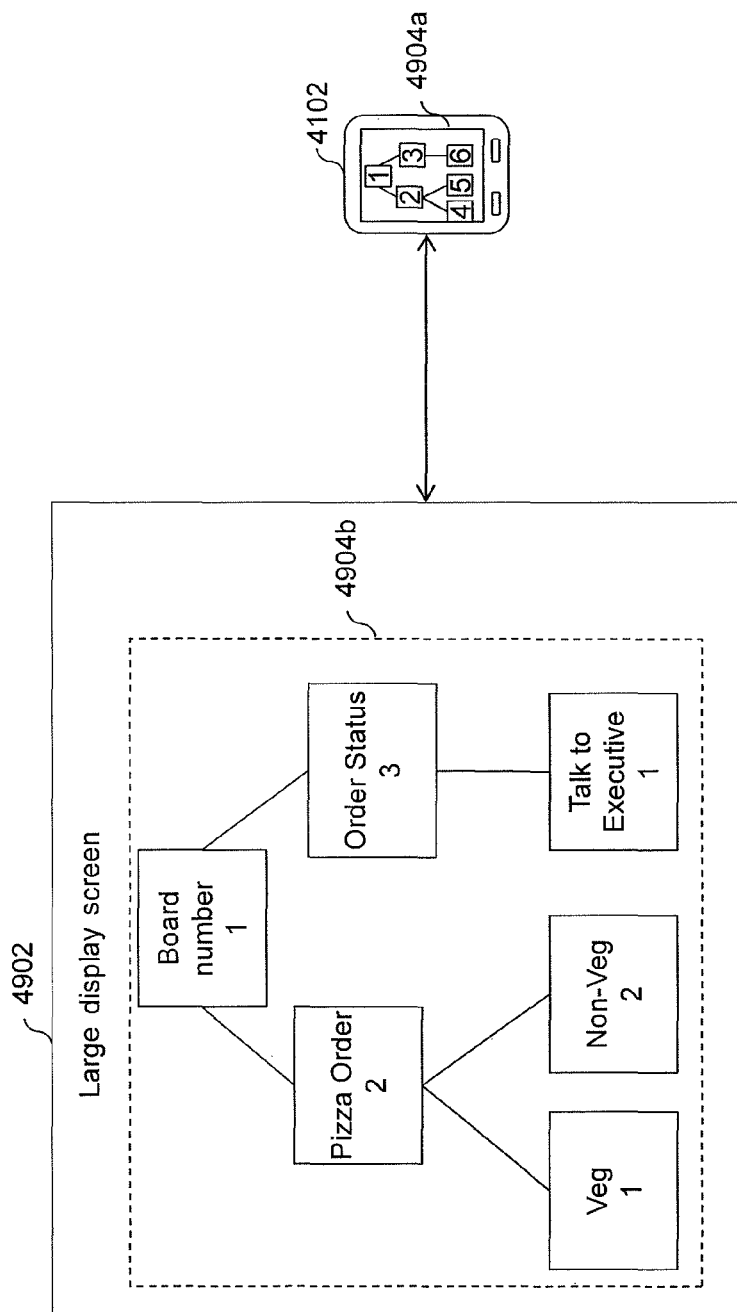

FIG. 49

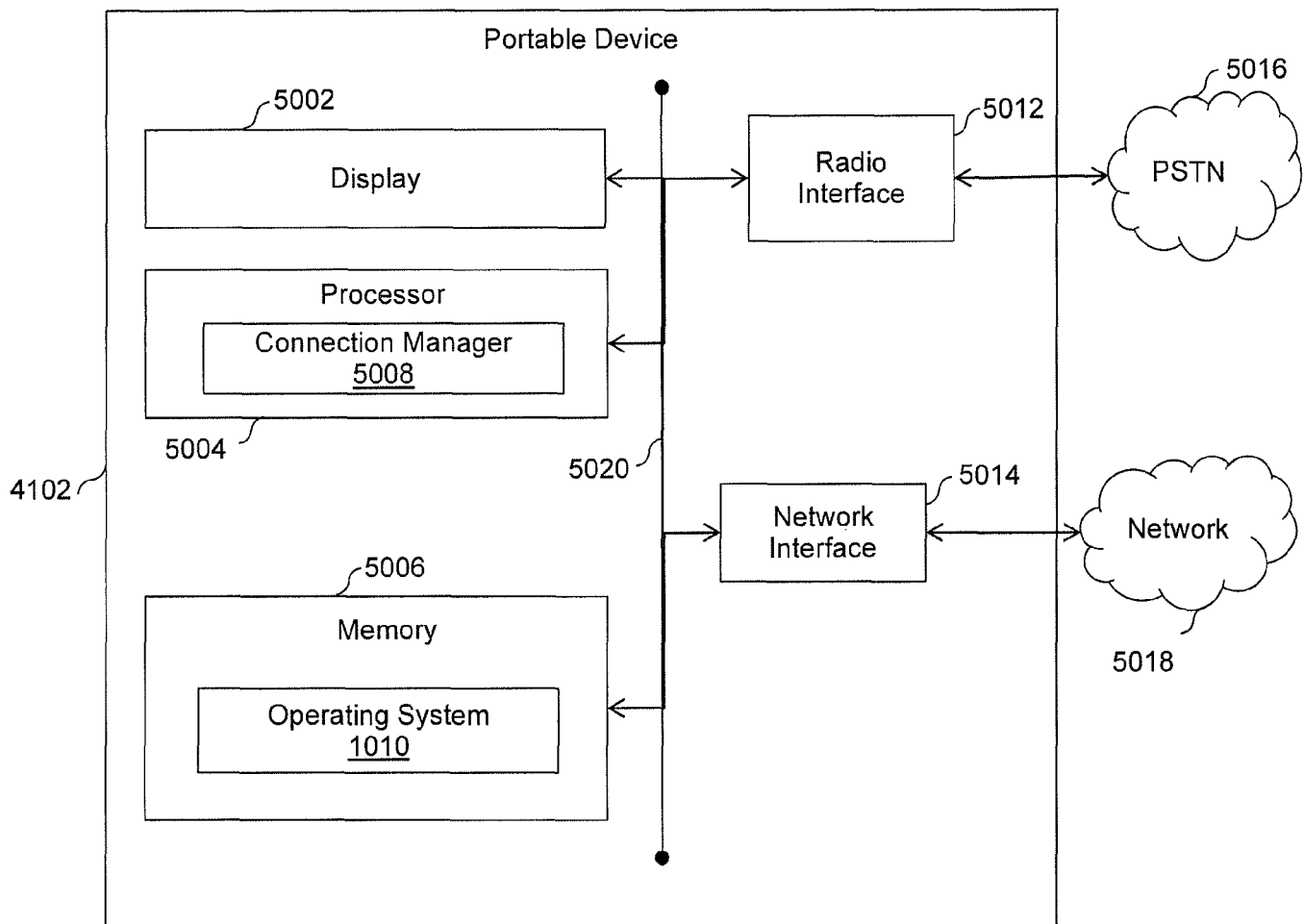

FIG. 50

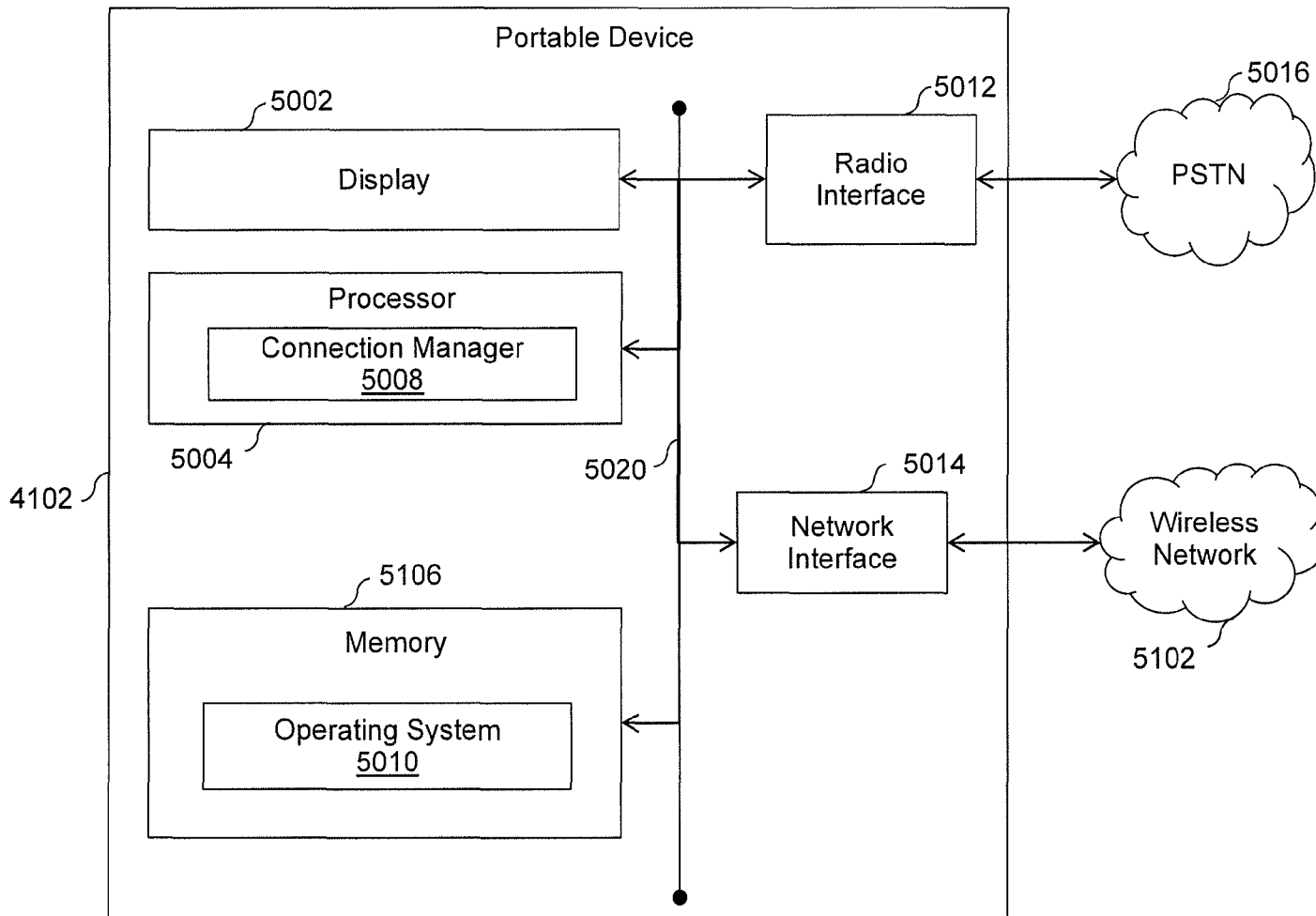

FIG. 51

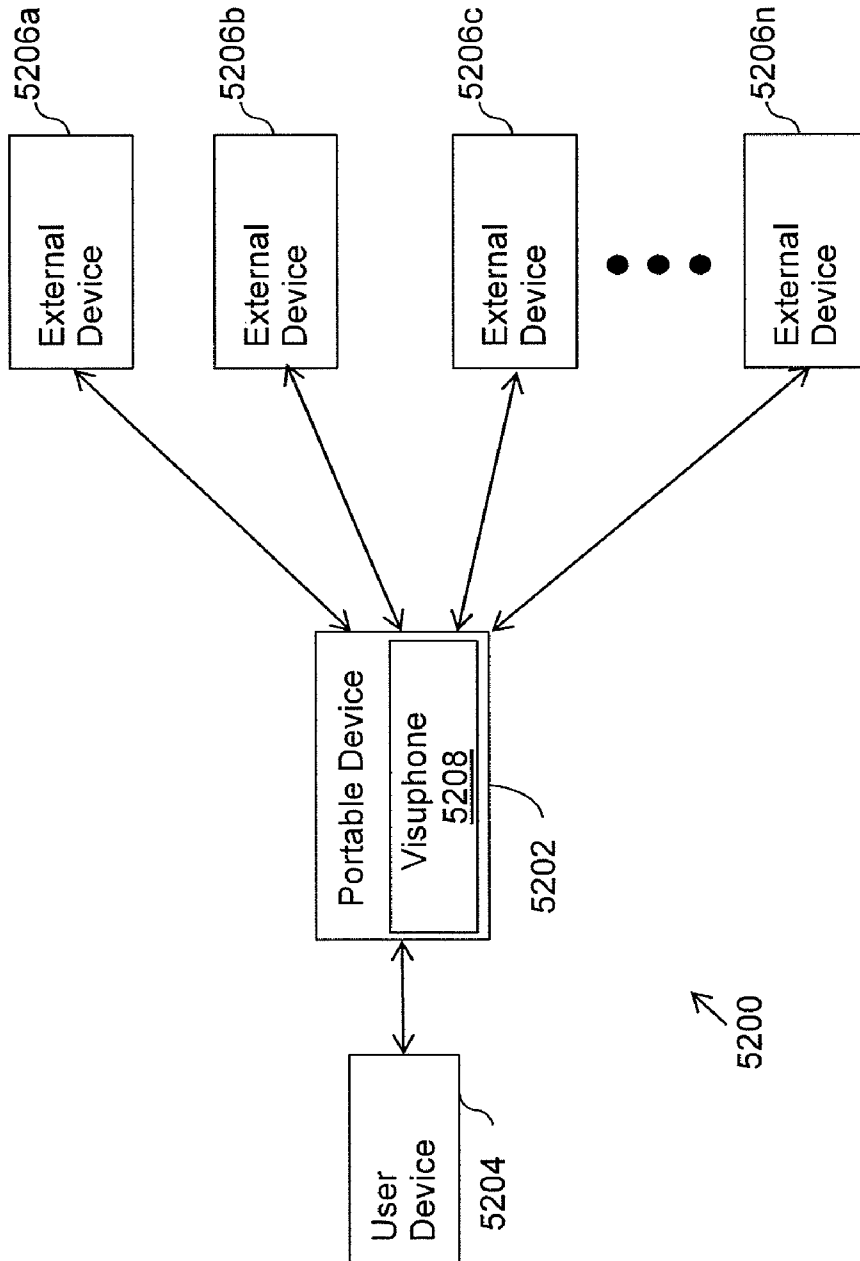

FIG. 52

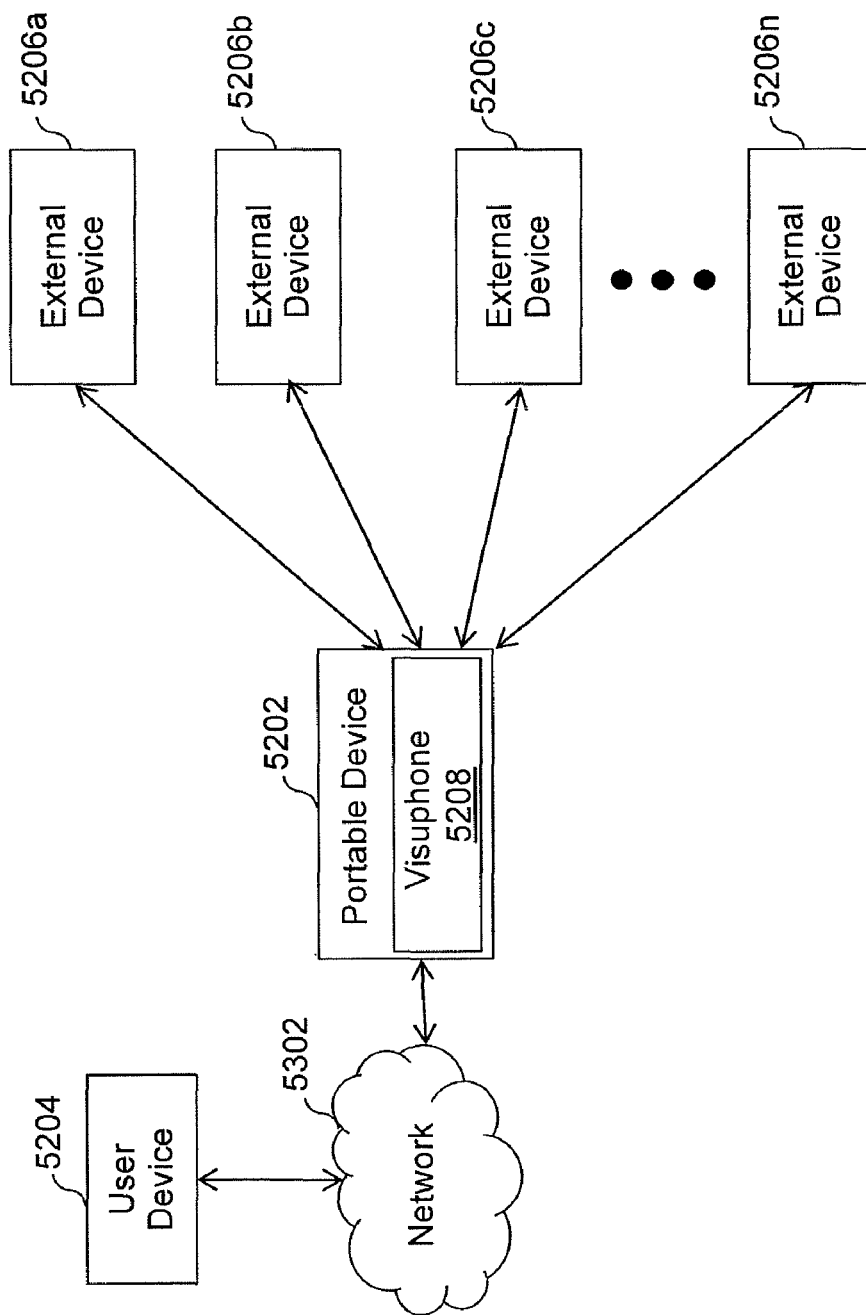

FIG. 53

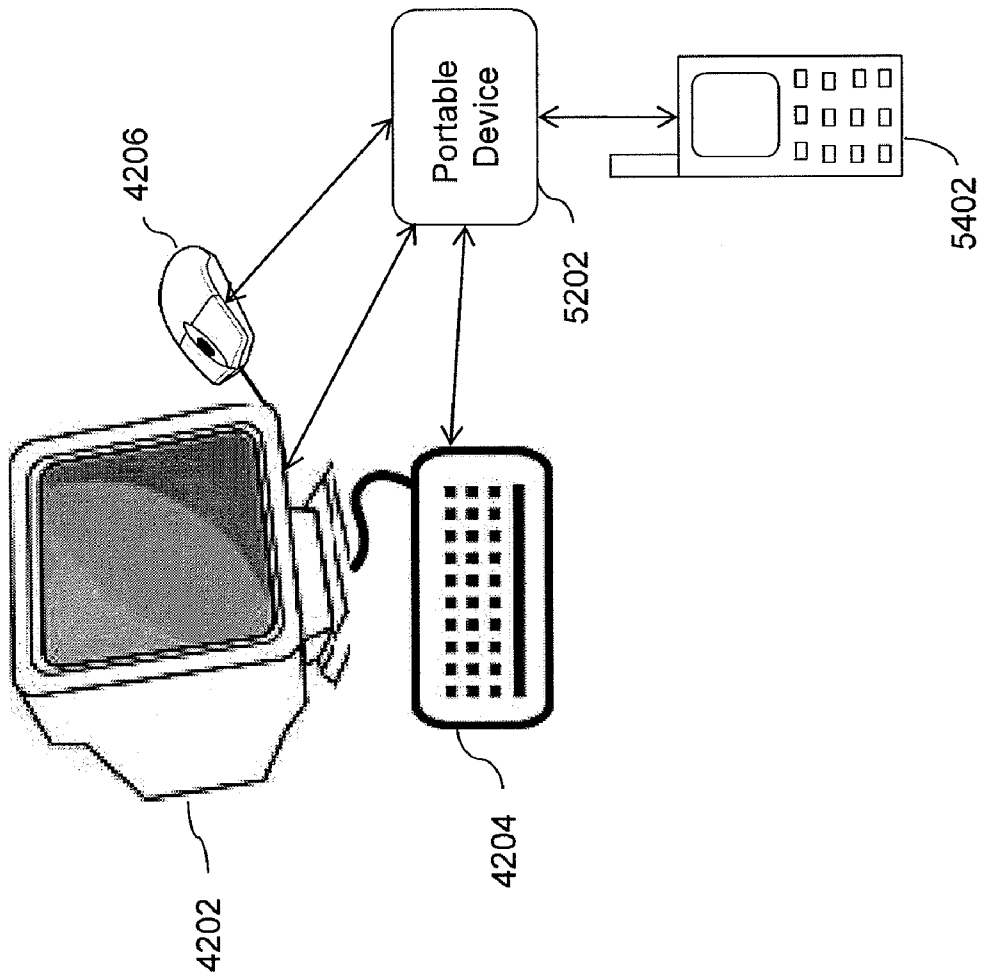

FIG. 54

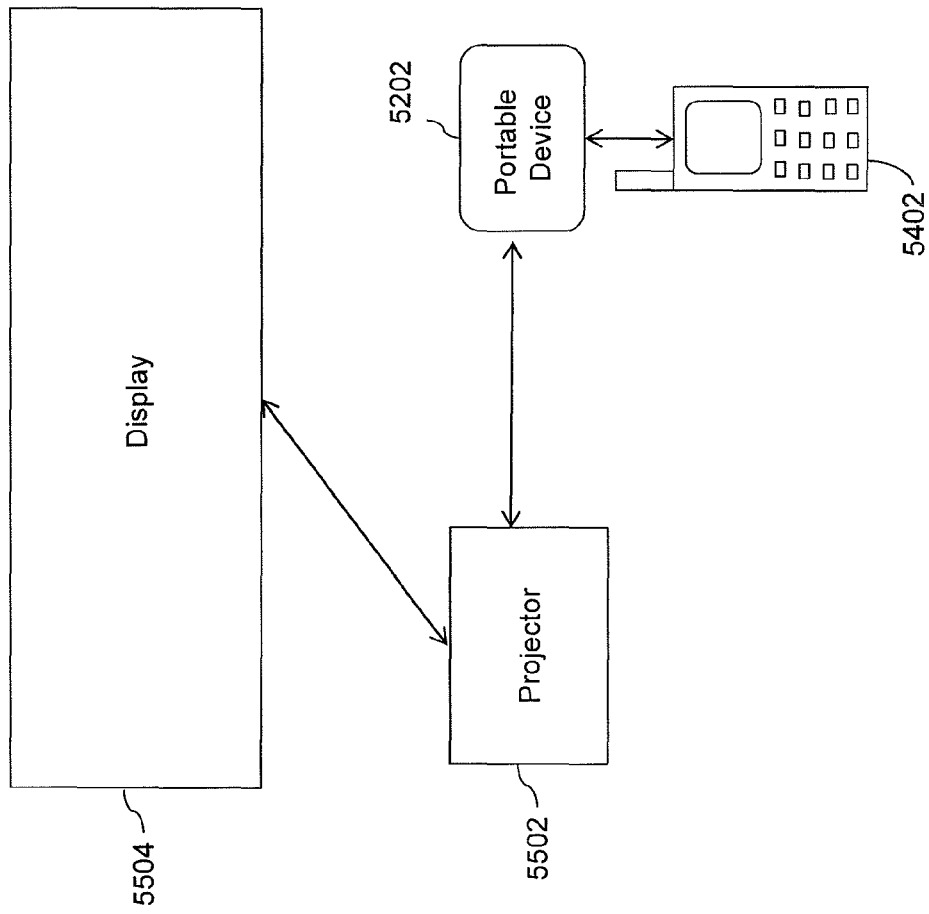

FIG. 55

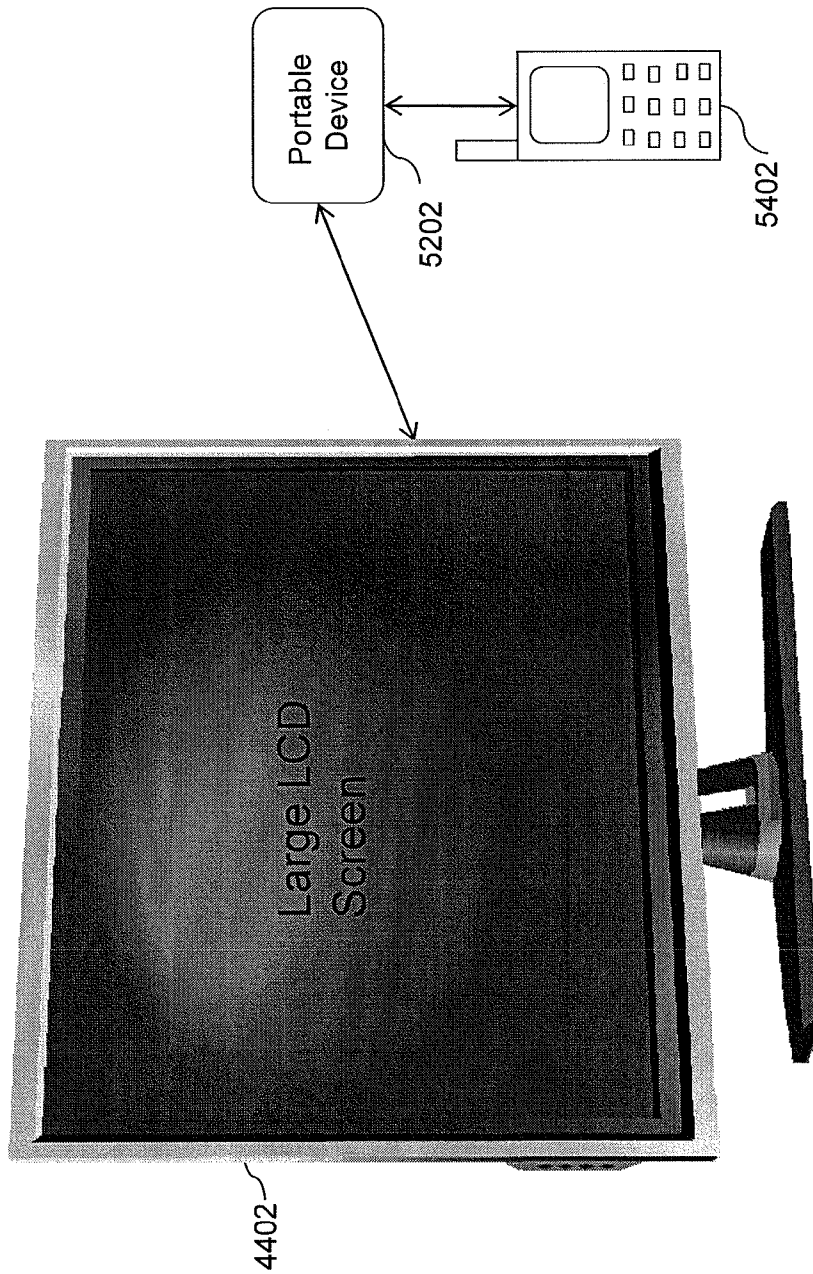

FIG. 56

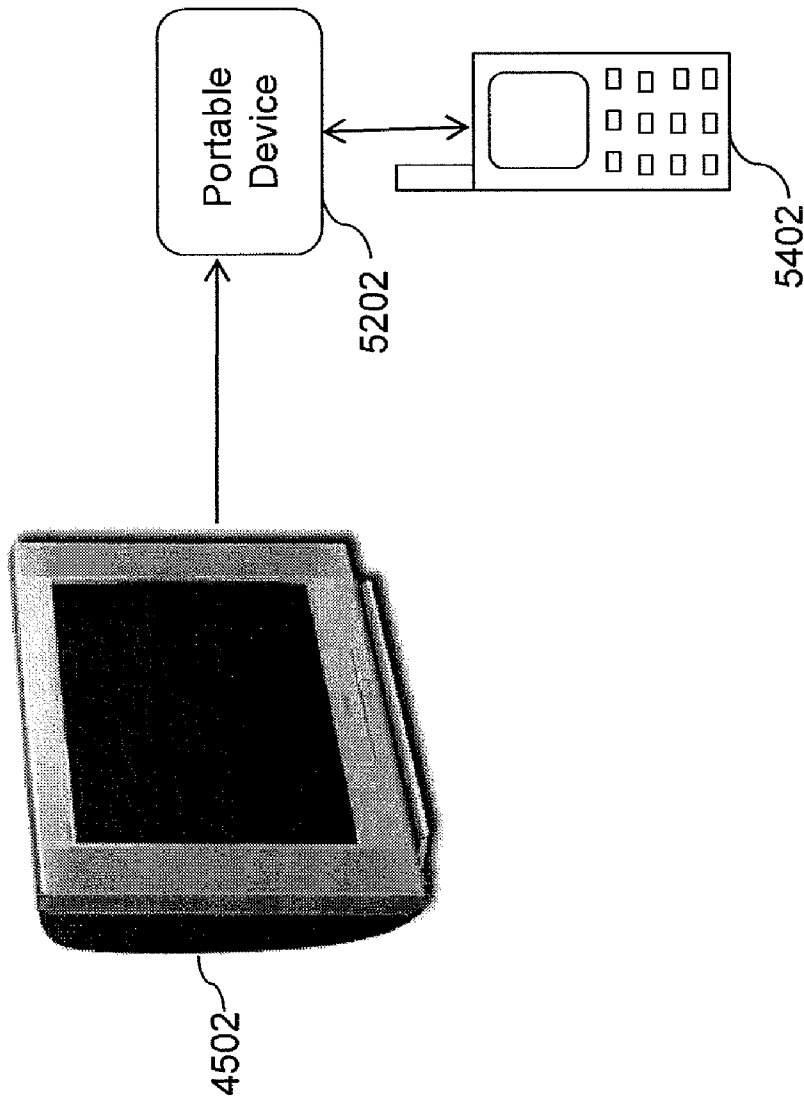

FIG. 57

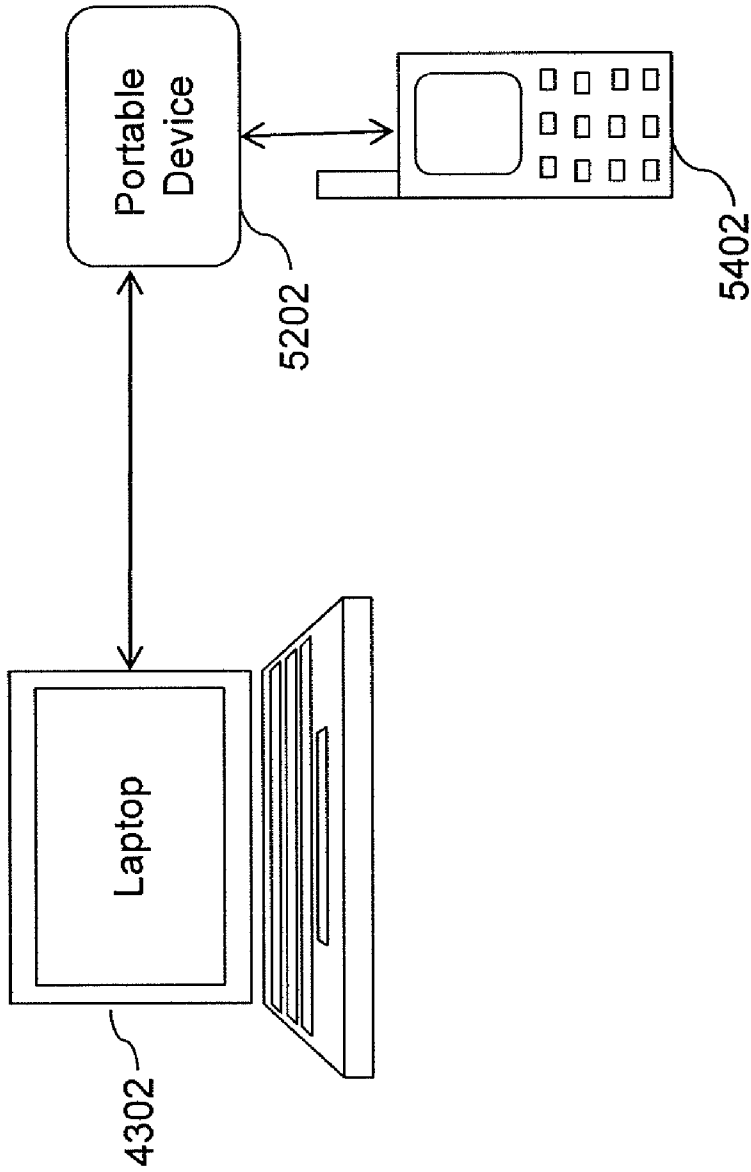

FIG. 58

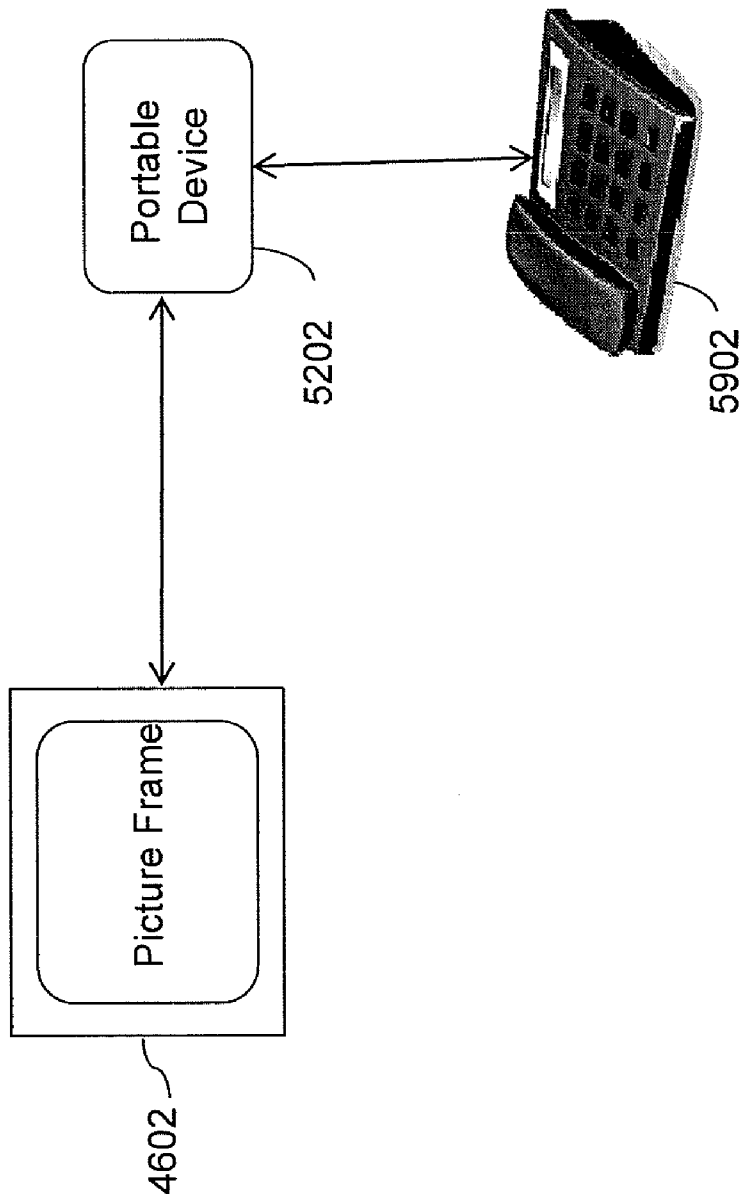

FIG. 59

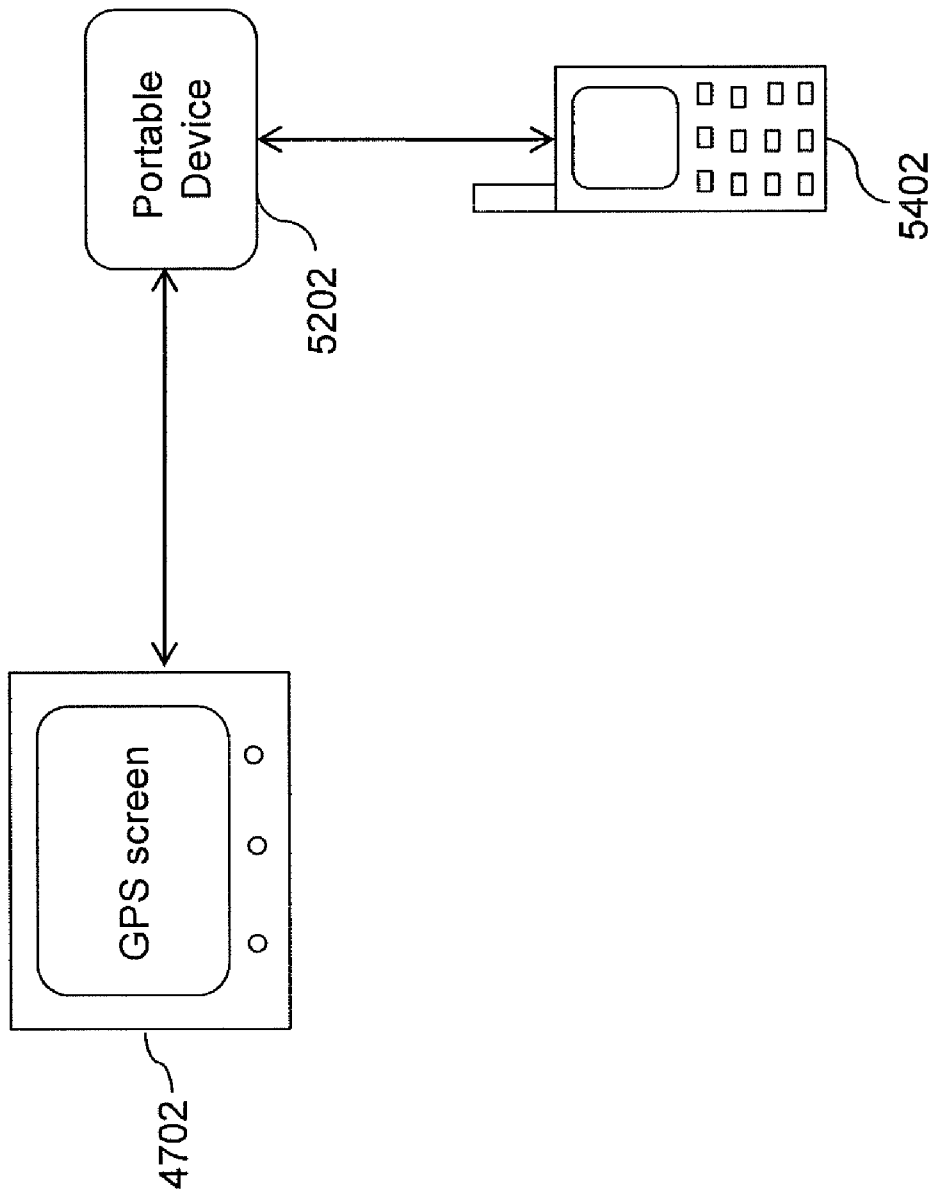

FIG. 60

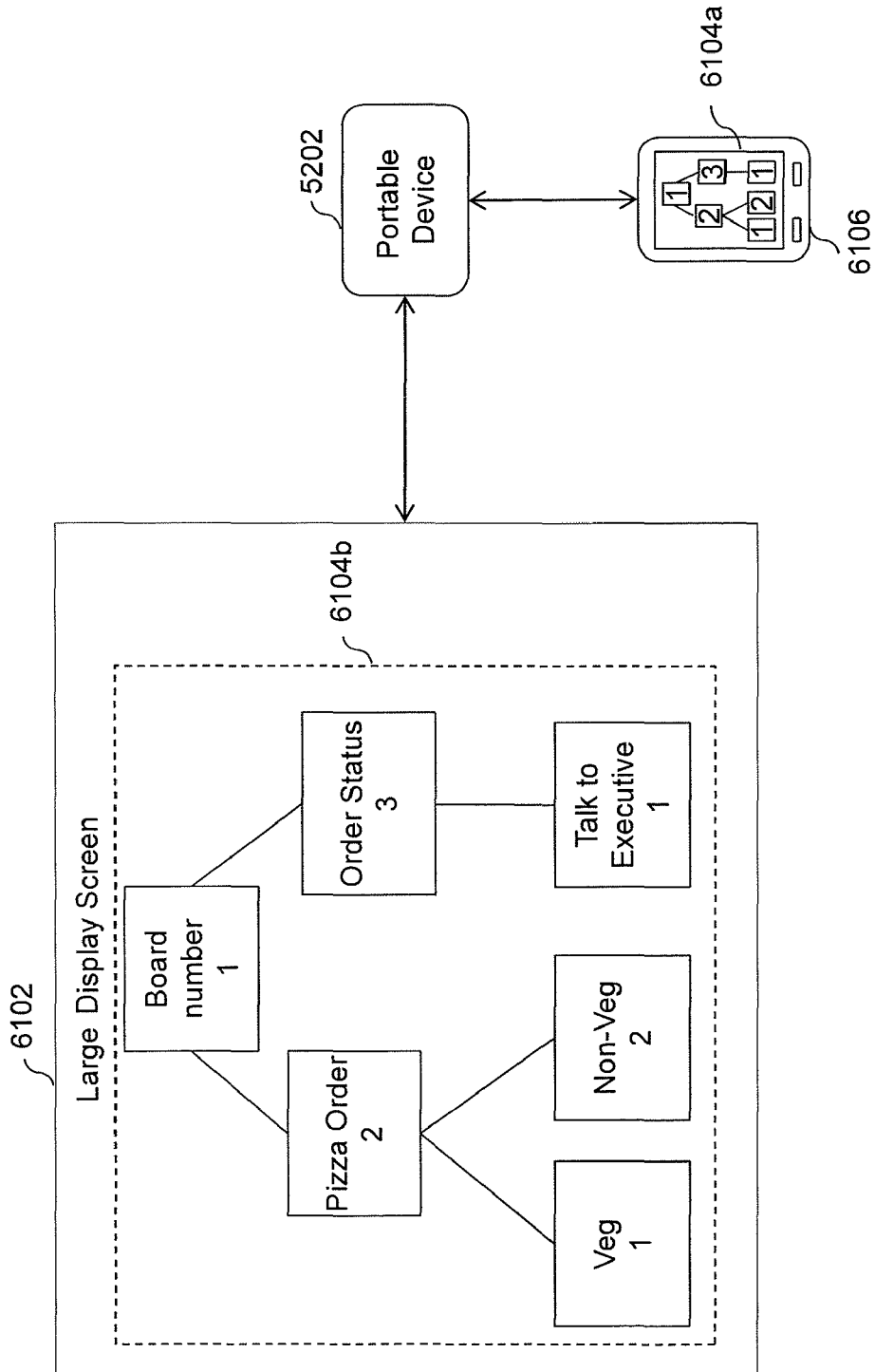

FIG. 61

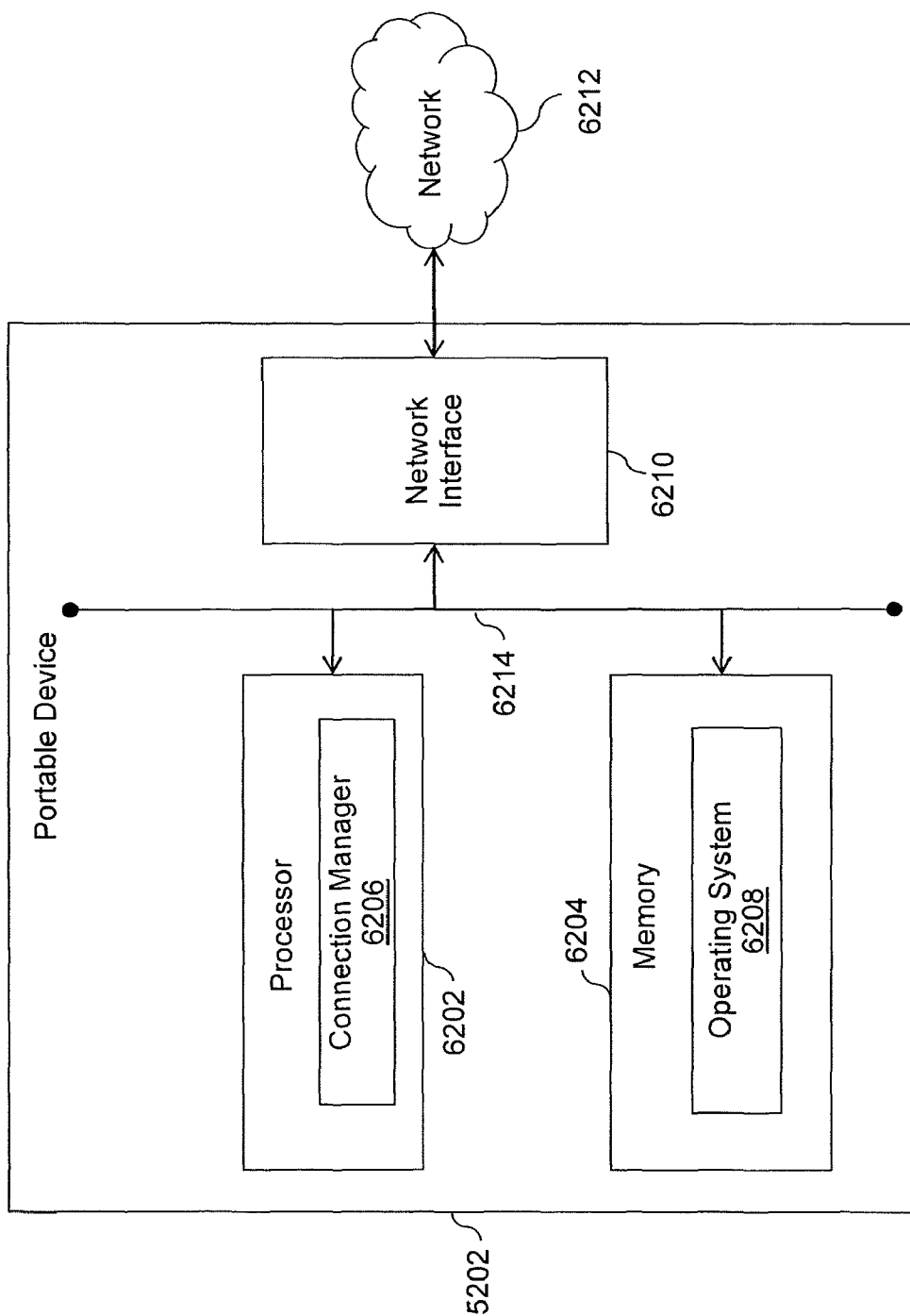

FIG. 62

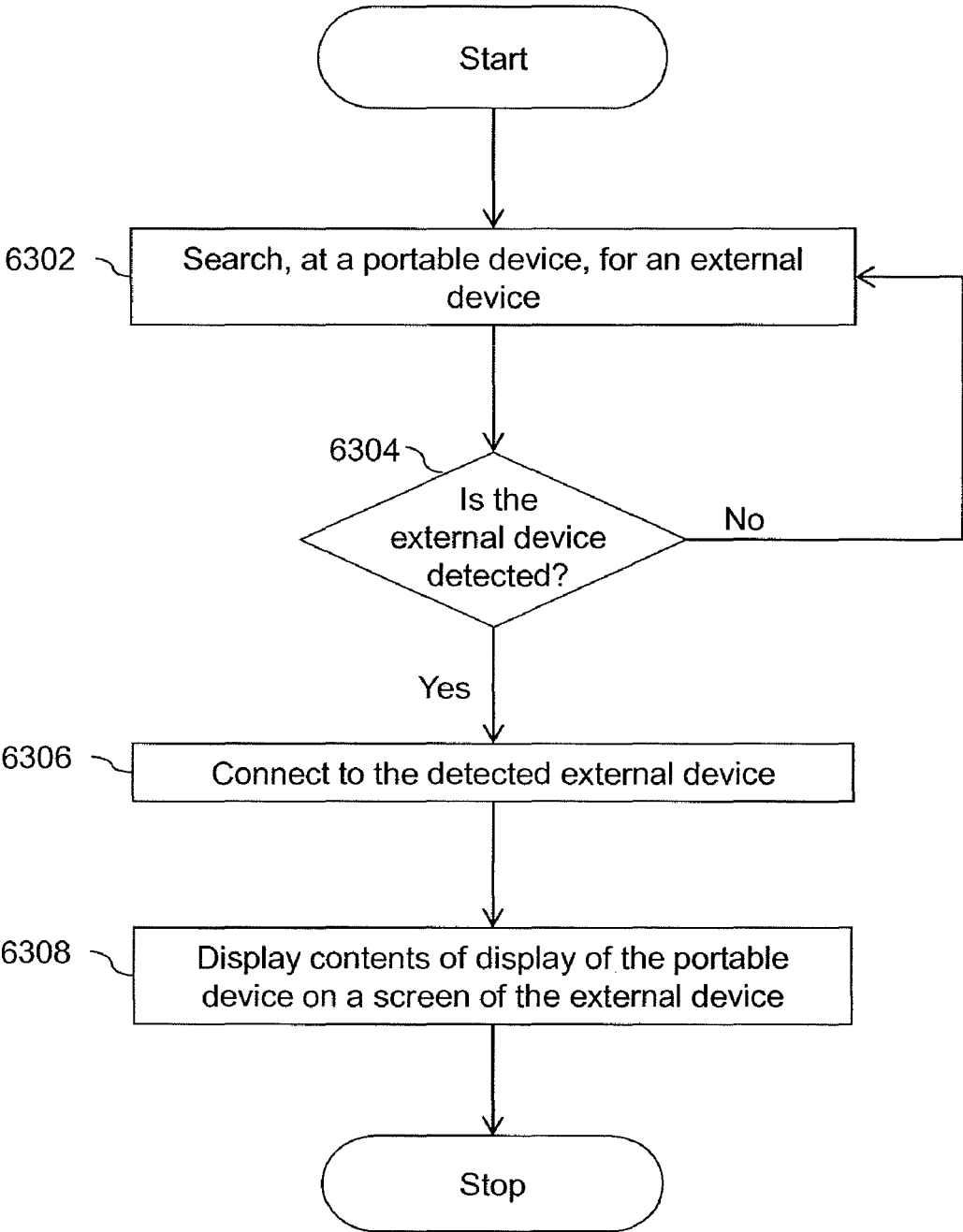

FIG. 63

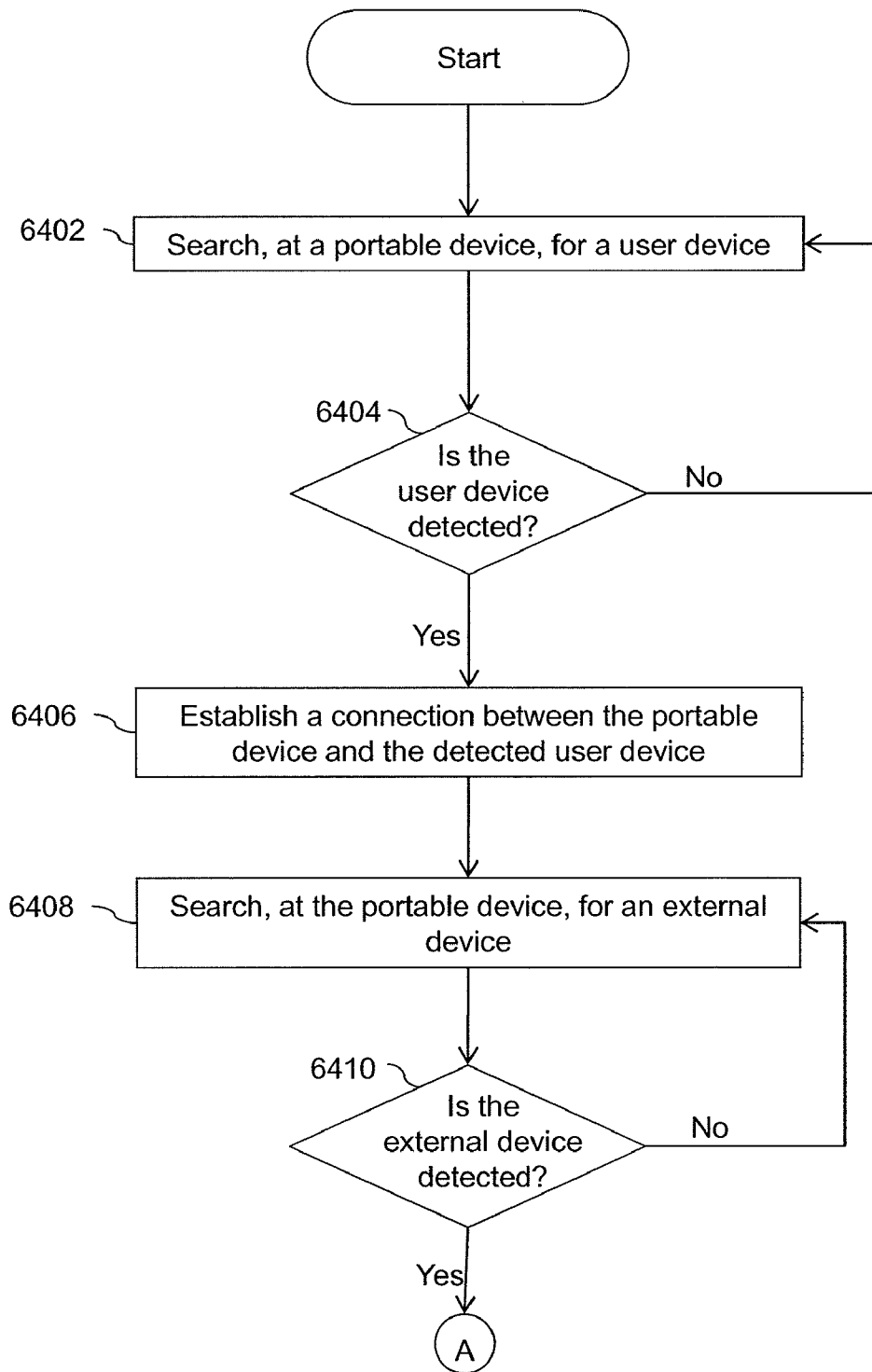

FIG. 64A

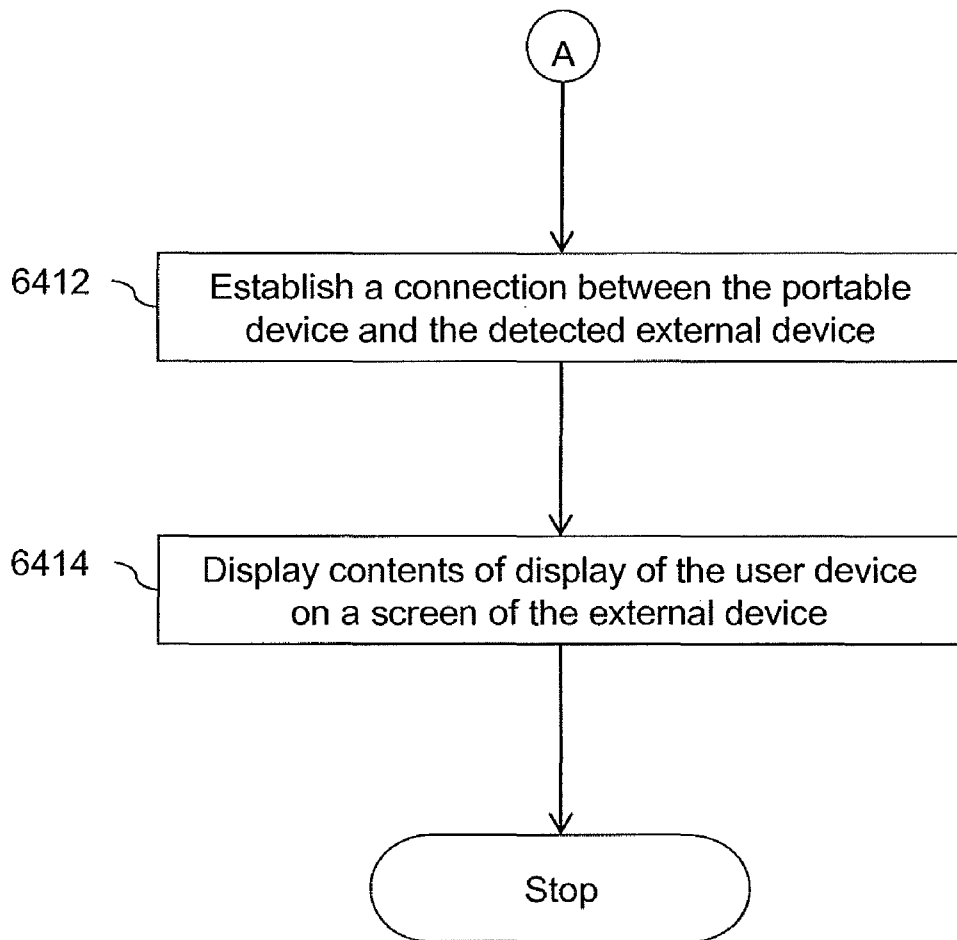

FIG. 64B

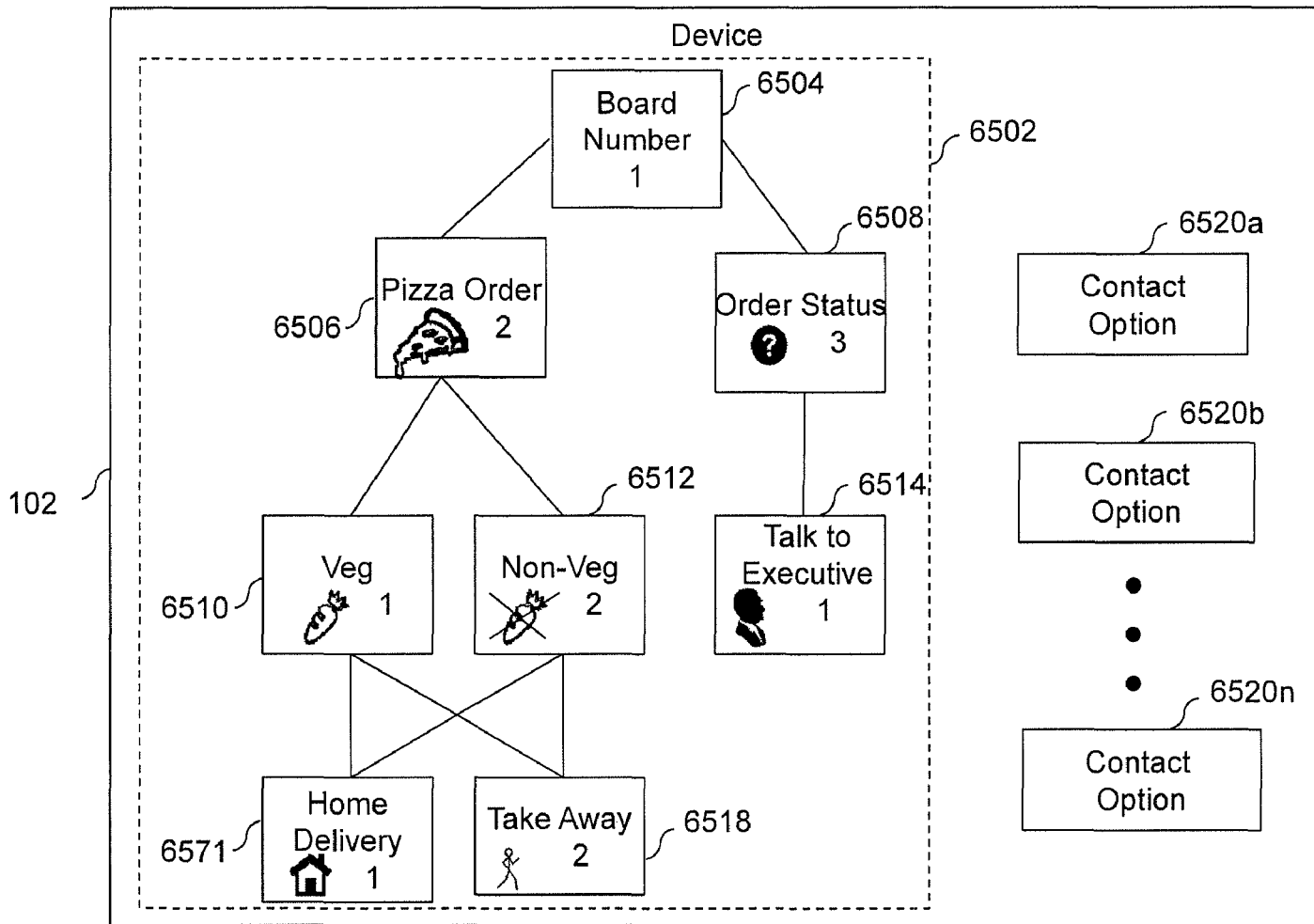

FIG.65

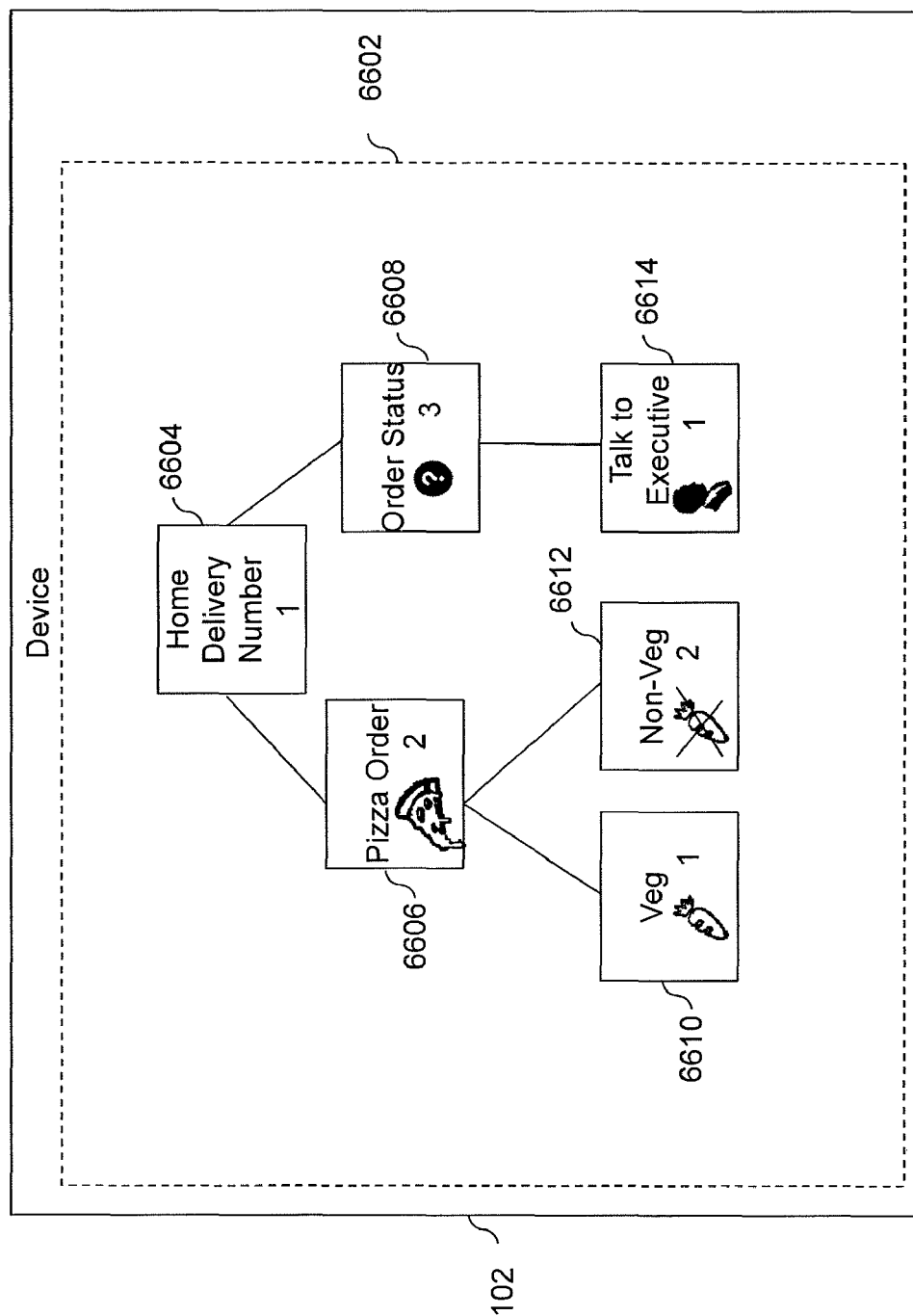

FIG. 66

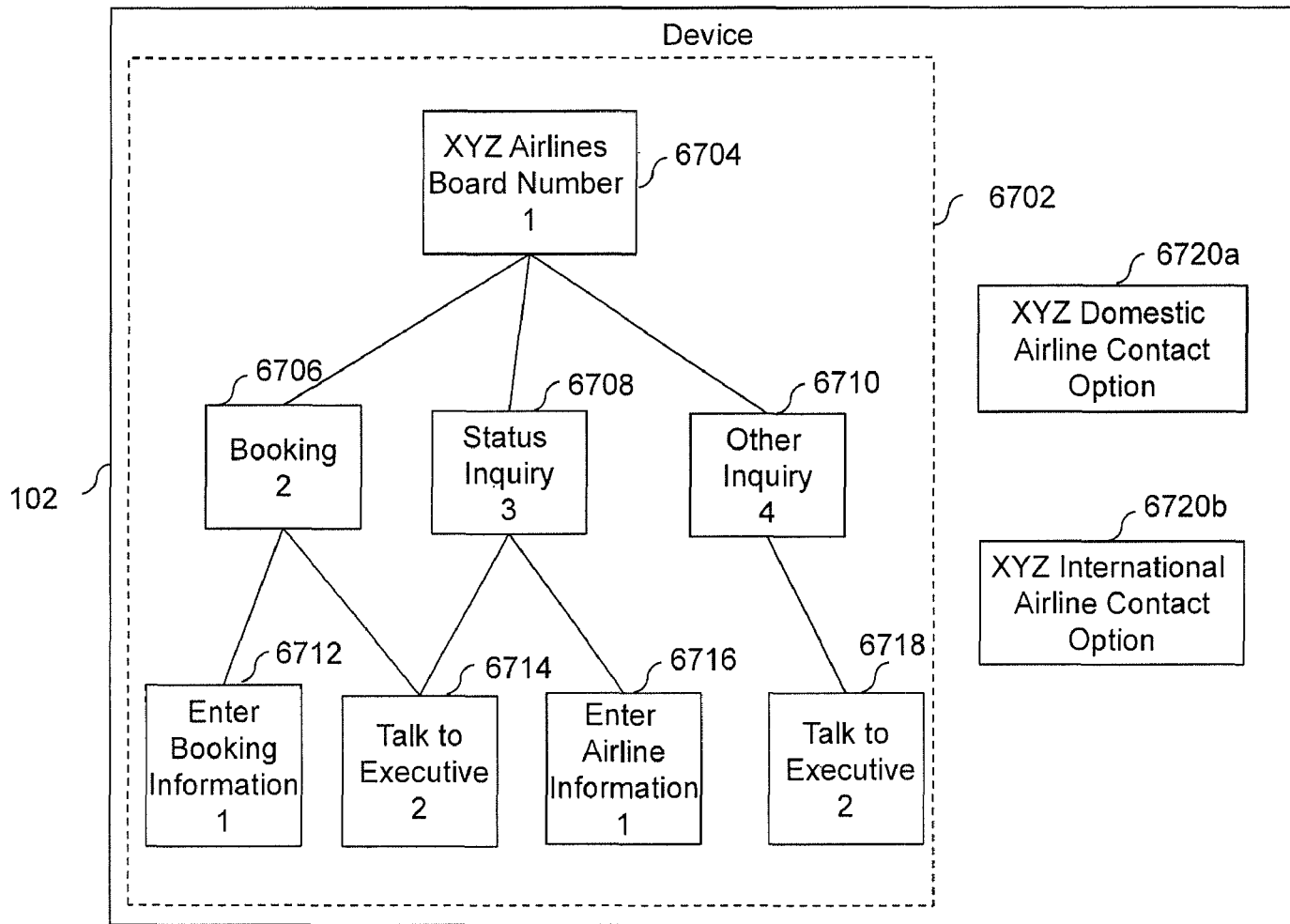

FIG.67

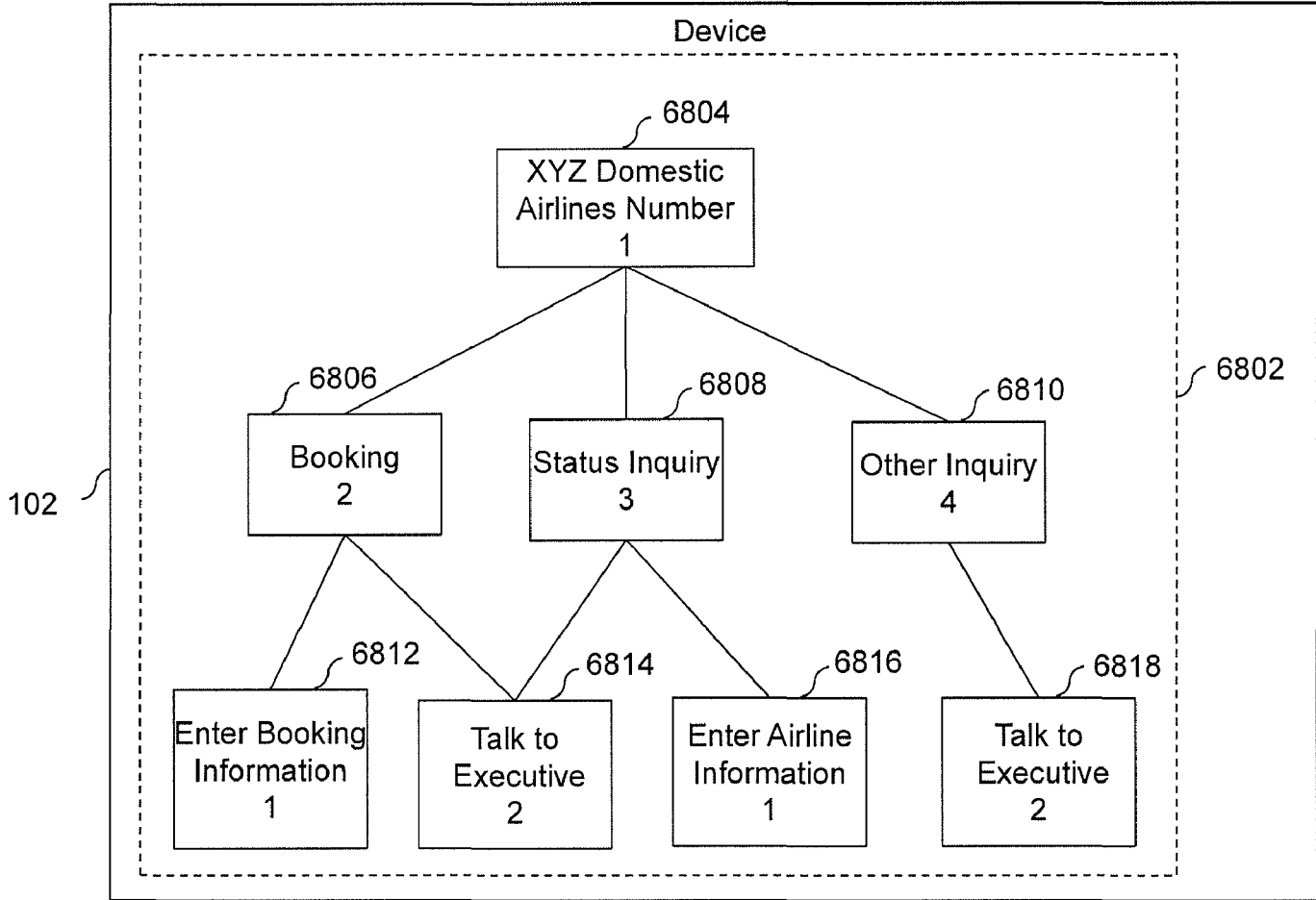

FIG.68

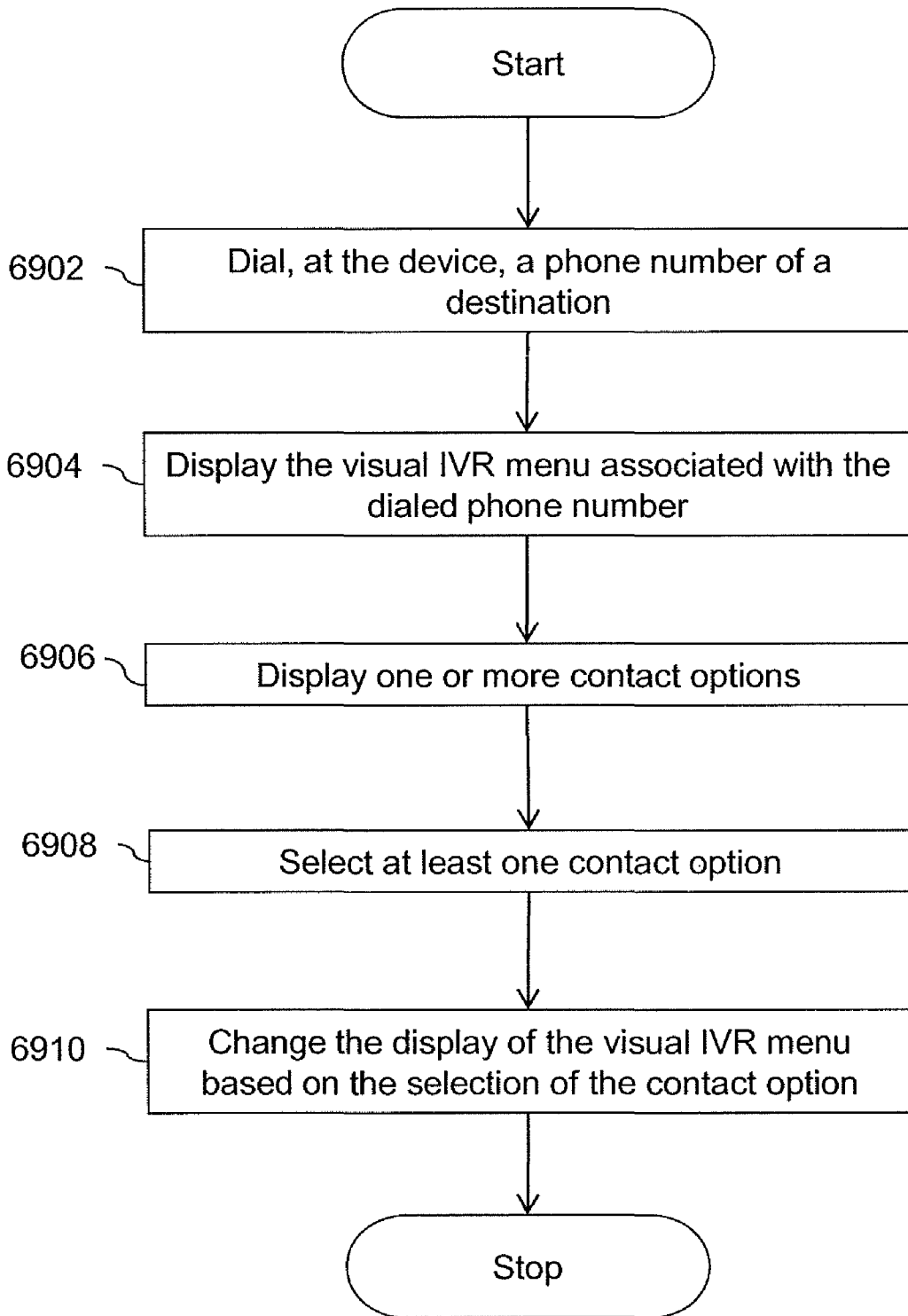

FIG. 69

1

SYSTEMS AND METHODS FOR VISUAL PRESENTATION AND SELECTION OF IVR MENU

CROSS-REFERENCE TO RELATED APPLICATIONS

This application is a continuation of U.S. patent application Ser. No. 13/186,984, filed Jul. 20, 2011, the entire contents of which are incorporated herein in their entirety by reference.

FIELD OF THE INVENTION

The invention relates to Interactive Voice Response (IVR) system and more specifically the invention relates to visual selection of IVR option from a caller device.

BACKGROUND OF THE INVENTION

Interactive Voice Response (IVR) technology is generally used to detect voice and key inputs from a caller. The advent of Interactive Voice Response (IVR) systems has reduced operating costs for many types of businesses for providing services. Generally, the IVR systems allow a user to interact with an audio or visual response system. The IVR systems can provide prompts to a user and receive touch tone and/or spoken responses on the prompts from the user. Through such IVR dialogue the system collects sufficient information about the user to direct the call to the most appropriate resource, information processing system or the like.

Generally, when the caller calls a destination, such as a bank, an automated audio IVR menu is played. The audio IVR menu can contain instructions to provide instant services such as account balance inquiry when the destination is a bank. Further, audio menu can provide options for the caller to connect to a desired end inside the destination. For example, the menu may direct the caller to press various keys on a telephone to connect to a particular department or agent. The audio IVR menu is designed specific to a destination. Therefore, each destination or organization may have different audio IVR menus. Further, the IVR menu in an organization can be based on the type of departments, type of services, customer care executives or agents and so forth. For example, an IVR menu of a bank may include options related to the account details of the caller, while an IVR menu of a pizzeria may contain options to order or select a pizza.

Typically, the caller calling the destination may have to listen and follow instructions on the menu to get a desired response or a function performed. Therefore, the process can be time consuming. Moreover, in case the caller provides an incorrect input, the complete process may have to be repeated. Furthermore, the IVR menu for an organization may be updated or changed regularly. For example, extension numbers inside an organization may be changed and correspondingly, the extension numbers associated with the IVR menu may be updated. As a result, a frequent caller may not be able to reach a desired end by remembering a combination of numbers. Furthermore, the dialed destination may not include the information desired by the user. In such a case, the user may have to call the destination again for retrieving the desired information. Therefore, the user may become frustrated with the IVR systems.

Usually, the IVR menus are same for all the users. Therefore, the customer has to listen them carefully to select the appropriate option. The user may have to wait for long time for receiving information while interacting with the IVR sys-

2

tems. Moreover, sometimes the requested information might not be available at the time when the user calls the destination. Therefore, the user may have to either wait for long time or call again later. For example, the user may desire to talk to a customer care executive of the destination, who is busy at the time of the call. Therefore, the call of the user may be put on hold or he may be asked to call later.

Some prior art try to address this problem by providing visual form of IVR. These prior arts display the IVR menu graphically on a caller device. U.S. Pat. No. 7,215,743 assigned to International Business Machines Corporation and a published U.S. Patent Application with Ser. No. 11/957,605, filed Dec. 17, 2007 and assigned to Motorola Inc., provides the IVR menu of the destination in a visual form to the caller. The caller can select the options from the IVR menu without listening to the complete audio IVR menu. However, the IVR menu displayed on the caller device is stored on an IVR server at the destination end. As a result, the visual IVR menu is specific to the destination and only the IVR of the destination dialed is displayed. These techniques therefore, require each destination to set-up hardware, software and other facilities to be deployed for providing visual IVR servers.

A U.S. Pat. No. 7,460,652, assigned to AT&T Intellectual Property I, L.P., discloses techniques for call routing and communication with a call originator. The call may be received at an automated call handling system. Thereafter, the call is evaluated based on a set of business rules and routed to an interactive voice response unit based on the evaluation. Further, the interactive voice response unit automatically schedules and sends an email to the originator of the call. However, the scheduling of the email is performed after establishing a communication with the automated call handling system. Moreover, the scheduling is performed at the automated call handling system.

Another existing technique as disclosed in U.S. Pat. No. 6,560,320 assigned to International Business Machines Corporation enables an operator of the IVR to send customized signals to the caller for generating and displaying graphical elements on the device of the caller. Thereafter, the caller can respond by selecting options through touch-screen interface of the device. Dual Tone Multi frequency (DTMF) signals of the IVR. However, this technique requires a specifically configured device to interpret the codes sent as Dual Tone Multi frequency (DTMF) signals for generating the graphics. Moreover, an operator is required to present the graphics to the caller. Furthermore, specialized software and hardware are required at the operator to design and generate DTMF codes. Therefore, the technique faces various practical limitations.

Generally, the IVR menus of the organizations are in form of audible menu. Moreover, there are a large number of organizations that use IVR menus. Therefore, converting the audible menus to visual IVR menus can be time consuming. An existing technique, as disclosed in U.S. Pat. No. 6,920,425 assigned to Nortel Networks Limited, discloses an automated script to convert the audible menu scripts to visual IVR menu scripts. However, the audible menu scripts must be available in a particular format to enable the conversion. Furthermore, the audio menu scripts must be available or downloadable for the program to function. As a result, only the audio menu scripts that are available can be converted to visual IVR menu scripts. Furthermore, the device of the caller must be designed or programmed to understand the visual IVR menu scripts.

Various organizations encourage the customers to call them for information on their products or services, or for helping existing customers. Generally, a contact number is provided by the organizations on their website as a button.

Therefore, when the customer presses the button a form is displayed. The customer then enters his contact number where an executive from the organization may call. However, this may be time consuming for the customer. Moreover, the customer may be not being able to talk to another executive during the call in case the on-line executive is not able to satisfy the customer. U.S. Patent Application with Ser. No. 12/049,021, filed Mar. 14, 2008 and assigned to Harprit Singh, provides methods and systems for displaying an IVR menu, when the caller clicks a link on a webpage provided by the organization. However, the customer is still required to request the webpage with embedded information from a server of the organization. Moreover, the methods and systems are limited to the organizations that provide the required webpage to the customers. Other technologies include U.S. Patent Application with Ser. No. 11/877,952 filed Oct. 24, 2007 and assigned to International Business Machine Corporation.

The effectiveness of providing the IVR in visual form is discussed in a technical paper titled, 'The Benefits of Augmenting Telephone Voice Menu Navigation with Visual Browsing and Search' by Min Yin et al. The paper discusses a setup where visual content of the IVR is sent from a service provider to a computer connected to a mobile phone. However, the technique discussed in the paper is limited to the visual content provided by the service provider's end, after the connection is established. Moreover, the providers are required to individually set up the hardware and services for providing visual content.

As discussed above the existing technologies have various limitations. Hence, techniques are desired for providing enhanced telephony.

SUMMARY

An enhanced telephone system is provided. The telephone system comprises a database that comprises one or more phone numbers and one or more menus corresponding to the phone numbers, wherein the menus comprise one or more options for selection. The telephone system comprises means for comparing a dialed number to the phone numbers in the database; means for displaying a menu based on a result of the comparison; means for enabling selection of the one or more options from the displayed menu; and means for establishing a connection with a destination of the dialed number based on the selection of the one or more options.

An enhanced telephone system is provided. The telephone system comprises a database comprising one or more phone numbers and one or more menus corresponding to the phone numbers, wherein the menus comprises one or more options for selection; means for comparing the a received number of a received call to the phone numbers in the database; means for displaying a menu based on a result of the comparison; and means for enabling selection of the one or more options from the displayed menu.

Further, a method for providing enhanced telephony is provided. The method comprising identifying a number dialed from a telephone system; comparing the dialed number to one or more phone numbers stored in a database, wherein the database comprises one or more menus corresponding to the phone numbers, and wherein the menus comprises one or more options for selection; and displaying on the telephone system a menu from the database based on a result of the comparison.

A caller may dial or select a phone number from a device of a destination. The phone number is detected by a Visuphone implemented on the device to display a visual IVR menu

corresponding to the audible IVR menu of the destination. Visuphone may be hardware, an application stored as a software or firmware on the device, or a combination thereof. Visuphone may include a database of visual IVR menus corresponding to audible IVR menus for various destinations. Thereafter, the caller may interact with the visual IVR menu displayed on the device to establish a connection with the destination. Furthermore, Visuphone may detect and launch a VOIP application for establishing the connection. Moreover, Visuphone may provide pre-recorded or computer synthesized audio responses on behalf of the caller to the destination.

An aspect of the invention is to generate a database of visual IVR menus. The database generation could be done by successive calling the IVR and combined with voice recognition. Calling the IVR systems can be done manually by operators that will listen to options of the IVR and enter these options into the database. In this manual mode, the operator will dial IVR numbers from a list and for each of them will follow all the options in several levels and in each level, enter the menu entries into the database. This can be done to many different IVR phone numbers, by one or multiple operators. The voice menu can be recorded to for analyzing in a different process or a different time.

Another aspect of the invention is to generate a database of visual IVR menus by a computer system. Combination of hardware and software that is connected to phone system and automatically dials the IVR phone numbers, record the different options of the voice menu, analyze the voice menu and generate and enter the different entries into the database. The system will generate the voice tone that simulates the relevant touchtone of a phone number pressed. This process will be done in several levels until covering all the entries in all the levels of the specific IVR system. This process is done for all the IVR phone number in the list.

Additional alternative is to access the IVR internal database and download the menu. This approach requires the collaboration with the IVR maker and at least permission from the IVR owner. Having both a system could be build to access IVR using their maintenance port, which is often connected to the Internet. Accordingly, the system would access the IVR and once authorized by the IVR owner it will download the internal file representing the IVR menu, which could be called the IVR customization record. The downloaded file would then be converted to visual IVR menu by utility that could be design according to the format, which could be provided by the IVR maker.

Another aspect of the invention is to provide to a caller using a device a visual IVR menu corresponding to an audible IVR menu of a destination.

Another aspect of the invention is to enable the caller to directly interact with the visual IVR menu without listening to the audible IVR menu of the destination.

Another aspect of the invention is to provide the visual IVR menu to the caller before establishing a connection of the device with the destination.

Another aspect of the invention is to provide advertisements related to the destination or function of the destination dialed by the caller.

Yet another aspect of the invention is to provide a visual IVR menu of a destination according to the location of the communication device of a caller and/or a location of the dialed destination phone number.

Embodiments of the invention provide an enhanced communication device. The enhanced communication device comprises a processor and a memory coupled to the processor. The memory comprises a database including one or more

5

destination phone numbers and at least one property associated with the destination phone numbers. Further, the memory comprises instructions executable by the processor for identifying a dialed phone number of a destination, determining a location code associated with a current location of the communication device, comparing the dialed phone number to one or more destination phone numbers stored in a database, and displaying at least one property associated with the one or more destination phone numbers based on the comparison.

Embodiments of the invention provide an enhanced communication device. The enhanced communication device comprises a database including one or more destination phone numbers and at least one property associated with the destination phone numbers. Further, the enhanced communication device comprises means for identifying a dialed phone number of a destination, means for determining a location code associated with a current location of the communication device, means for comparing the dialed phone number to one or more destination phone numbers stored in a database, and means for displaying at least one property associated with the one or more destination phone numbers based on the comparison.

Embodiments of the invention provide a method for providing enhanced telephony. The method includes identifying a phone number of a destination dialed from a communication device; determining a location code associated with a current location of the communication device; and comparing the dialed phone number to one or more destination phone numbers stored in a database. The database may include at least one property associated with the destination phone numbers. Further, the method includes displaying the at least one property associated with the one or more destination phone numbers based on the comparison.

Embodiments of the invention provide an enhanced device. The enhanced device comprises a processor and a memory coupled to the processor. The memory comprises a database including one or more destination phone numbers and at least one property associated with the destination phone numbers. Further, the memory comprises instructions executable by the processor for identifying a dialed phone number of a destination, determining a location code associated with a current location of the device, comparing the dialed phone number to one or more destination phone numbers stored in a database, and displaying at least one property associated with the one or more destination phone numbers based on the comparison.

Embodiments of the invention provide an enhanced device. The enhanced device comprises a database including one or more destination phone numbers and at least one property associated with the destination phone numbers. Further, the enhanced device comprises means for identifying a dialed phone number of a destination, means for determining a location code associated with a current location of the device, means for comparing the dialed phone number to one or more destination phone numbers stored in a database, and means for displaying at least one property associated with the one or more destination phone numbers based on the comparison.

Embodiments of the invention provide a method for providing enhanced telephony. The method includes identifying a phone number of a destination dialed from a device; determining a location code associated with a current location of the device; and comparing the dialed phone number to one or more destination phone numbers stored in a database. The database may include at least one property associated with the destination phone numbers. Further, the method includes displaying the at least one property associated with the one or more destination phone numbers based on the comparison.

6

Embodiments of the invention provide a device comprising a database comprising a plurality of visual IVR menus associated with a plurality of destinations. The device further comprises means for dialing a phone number of a destination, means for comparing the dialed phone number with phone numbers stored in the database, and means for displaying a form based on the comparison, wherein the form comprises one or more data request fields corresponding to a visual IVR menu associated with the dialed destination.

Embodiments of the invention provide a device comprising a processor. Further, the device comprises a memory comprising a database. The database comprises a plurality of visual IVR menus associated with a plurality of destinations. Further, the memory comprises instructions executable by the processor for dialing a phone number of a destination, comparing the dialed phone number with phone numbers stored in the database, and displaying a form based on the comparison, wherein the form comprises one or more data request fields corresponding to a visual IVR menu associated with the dialed destination.

Further, a method for providing enhanced telephony is disclosed. The method comprises dialing, at a device, a phone number of a destination. The device comprises a plurality of visual IVR menus associated with a plurality of destinations. Further, the method comprises comparing the dialed phone number with phone numbers stored in the device. Furthermore, the method comprises displaying, at the device, a form based on the comparison, wherein the form comprises one or more data request fields corresponding to a visual IVR menu associated with the dialed destination.

Embodiments of the invention provide a device for scheduling a call to a destination based on predefined calling information. The device comprises a database comprising at least one visual IVR menu associated with each of a plurality of destinations. The device also comprises means for dialing a phone number of a destination of the plurality of destinations based on the predefined calling information, wherein the predefined calling information is selected from a visual IVR menu associated with the destination; means for receiving information from the dialed destination based on the predefined calling information; and means for displaying the received information.

Embodiments of the invention disclose a method for providing scheduling a call to a destination based on predefined calling information. The method comprises dialing a phone number of a destination of a plurality of destinations based on the predefined calling information, wherein the predefined calling information is selected from a visual IVR menu associated with the destination. Further, the method comprises receiving information from the dialed destination based on the predefined calling information. Furthermore, the method comprises displaying the received information.

Embodiments of the present invention provide a device. The device comprises a processor. Further, the device comprises a memory coupled to the processor. The memory comprises a database comprising at least one IVR menu associated with at least one IVR system. Further, the memory comprises instructions executable by the processor for sending a first section of a data packet to a second communication device. The first section comprising first information is sent based on a visual IVR menu associated with the second communication device. Further, the memory comprises instructions executable by the processor for receiving an acknowledgement message from the second communication device based on the first section of the data packet. Furthermore, the memory includes instructions executable by the processor for sending a second section of the data packet to the second

communication device based on the acknowledgement message. The second section comprises second information.

Embodiments of the present invention provide a method for communicating among a plurality of communication devices. The method comprises sending, by a device, a first section of a data packet to a second communication device. The first section comprising first information is sent based on a visual Interactive Voice Response (IVR) menu associated with at least one IVR system. Further, the method comprises receiving, at the device, an acknowledgement message from the second communication device based on the first section of the data packet. Furthermore, the method comprises sending, by the device, a second section of the data packet to the second communication device based on the acknowledgement message. The second section comprises second information.

Embodiments of the invention provide a method for establishing a communication session in a communication network. The method comprises dialing, by a device, a phone number of a second communication device. The second communication device comprises an IVR system. Further, the method comprises detecting, by the device, a data network. Furthermore, the method comprises sending, by the device, a first section of a data packet to the dialed second communication device when the data network is detected. The first section comprises first information.

Embodiments of the invention provide a communication device comprising a database comprising a plurality of visual Interactive Voice Response (IVR) menus associated with a plurality of destinations. The communication device further comprises means for dialing a phone number of a destination, means for comparing the dialed phone number with phone numbers stored in the database, and means for displaying a form based on the comparison, wherein the form comprises one or more data request fields corresponding to a visual IVR menu associated with the dialed destination.

A method for providing enhanced telephony is disclosed. The method comprises dialing, at a communication device, a phone number of a destination. The communication device comprises a plurality of visual IVR menus associated with a plurality of destinations. Further, the method comprises comparing the dialed phone number with phone numbers stored in the communication device. Furthermore, the method comprises displaying, at the communication device, a form based on the comparison, wherein the form comprises one or more data request fields corresponding to a visual IVR menu associated with the dialed destination.

An aspect of the invention is to provide updates to the visual IVR menus stored in the device.

An aspect of the invention is to provide the visual IVR menu when the call is forwarded from one destination to another.

Another aspect of the present invention is to provide a method for displaying, at a device, a visual IVR menu associated with a phone number of a calling device. Further, the method displays one or more communication options at the device.

Another aspect of the invention is to enable a user at the device to interact with the visual IVR menu of the calling first party device without listening to the audible IVR menu of the first party device.

Yet another aspect of the invention is to enable a portable device or device to connect to an external device with better display capabilities.

Further aspect of the invention is to provide the visual IVR menu of a first party device to a user of a device before establishing a communication session between the device and the first party device.

Additional aspect of the invention is an automatic learning of caller choice and uses that for assisting the caller in his future calls.

BRIEF DESCRIPTION OF THE DRAWINGS

Having thus described the invention in general terms, reference will now be made to the accompanying drawings, which are not necessarily drawn to scale, and wherein:

FIG. 1A illustrates an exemplary environment where various embodiments of the invention may function;

FIG. 1B illustrates another exemplary environment where various embodiments of the invention may function;

FIG. 1C illustrates yet another exemplary environment where various embodiments of the invention may function;

FIG. 2A illustrates an exemplary audible Interactive Voice Response (IVR) menu at a destination, in accordance with an embodiment of the invention;

FIG. 2B illustrates an exemplary visual IVR menu at a device corresponding to the audible IVR menu of the destination, in accordance with an embodiment of the invention;

FIG. 2C illustrate an exemplary visual IVR menu that display graphics for each option, in accordance with an embodiment of the invention;

FIG. 2D illustrate an exemplary visual IVR menu that display tooltip when a cursor is hovering an option for more than certain time without action, in accordance with an embodiment of the invention;

FIGS. 3A and 3B illustrates exemplary components of the device for implementing a Visuphone, in accordance with an embodiment of the invention;

FIG. 4 illustrates an exemplary display of the visual IVR menu on the device, in accordance with an embodiment of the invention;

FIG. 5 illustrates exemplary components of the device for implementing the Visuphone, in accordance with another embodiment of the invention;

FIG. 6 illustrates an exemplary display of the visual IVR menu on the device, in accordance with another embodiment of the invention;

FIG. 7 illustrates a webpage displayed on the device that may be used to initiate a connection to the destination, in accordance with an embodiment of the invention;

FIG. 8 illustrates an exemplary software architecture of Visuphone, in accordance with an embodiment of the invention;

FIG. 9 illustrates exemplary components of the Visuphone, in accordance with an embodiment of the invention;

FIG. 10 illustrates an exemplary remote server for storing information required by the Visuphone, in accordance with an embodiment of the invention;

FIG. 11 illustrates presentation of a visual IVR menu in case of call forwarding, in accordance with an embodiment of the invention;

FIG. 12 illustrates the presentation of the visual IVR menu when a phone connection is associated with a wide band internet 'smart' modem;

FIG. 13 illustrates the presentation of the visual IVR menu when a telephone connection is established through an external telephone service by using a computer;

FIGS. 14A, 14B, and 14C illustrate a Visu-add-on that provides the features and functionality of the Visuphone;

FIGS. 15A, 15B, and 15C, and 15D illustrate a flowchart diagram for presentation, selection and update of visual IVR menus, in accordance with an embodiment of the invention;

FIG. 16 illustrates exemplary components of a device for implementing a database construction system, in accordance with an embodiment of the invention;

FIGS. 17A, 17B, and 17C illustrate exemplary components of the database construction system, in accordance with an embodiment of the invention;

FIG. 18 illustrates a flowchart diagram for creating a database for visual IVR menus, in accordance with an embodiment of the invention;

FIG. 19 illustrates an exemplary set of IVR categories;

FIG. 20A illustrates an exemplary information process stored in a database;

FIG. 20B illustrates an exemplary web form generated for the information process of FIG. 20A;

FIG. 21 illustrates an exemplary display of representations of destinations on the device, in accordance with an embodiment of the invention;

FIG. 22 illustrates an exemplary visual IVR menu of the selected destination with added graphics at a device, in accordance with an embodiment of the invention;

FIGS. 23A, 23B, and 23C illustrate a flowchart diagram for providing representation of destinations based on position, in accordance with an embodiment of the invention;

FIG. 24 illustrates flowchart for presenting advertisement along with the visual IVR menu on the device, in accordance with an embodiment of the invention;

FIG. 25A illustrates an exemplary information process for an IVR menu stored in records database, in accordance with an embodiment of the invention;

FIG. 25B illustrates an exemplary web form generated for the information process of FIG. 25A, in accordance with an embodiment of the invention;

FIG. 26 illustrates a flowchart for submitting personal information of a caller by Visuphone, in accordance with an embodiment of the invention;

FIG. 27 illustrates an exemplary representation of a visual IVR menu associated with the dialed phone number of the destination along with a scheduling mode option, in accordance with an embodiment of the invention;

FIG. 28 illustrates another exemplary representation of a visual IVR menu associated with the dialed phone number of the destination along with a scheduling mode option, in accordance with an embodiment of the invention;

FIG. 29 illustrates an exemplary display at the device after switching to a scheduling mode, in accordance with an embodiment of the invention;

FIGS. 30A and 30B illustrates a flowchart for providing enhanced telephony by presenting a scheduling mode option to the caller, in accordance with an embodiment of the invention;

FIGS. 31A, 31B, 31C and 31D illustrates exemplary environments where communication device may exchange one or more messages/data packets for establishing communication session, in accordance with various embodiments of the invention;

FIG. 32 illustrates an exemplary packet sent from a device to a second communication device, in accordance with an embodiment of the invention;

FIG. 33 illustrates an exemplary structure of a first section of the packet sent to the second communication device, in accordance with an embodiment of the invention;

FIGS. 34A and 34B illustrates a flowchart for communicating among a plurality of communication devices, in accordance with an embodiment of the invention;

FIGS. 35A, 35B, and 35C illustrates an exemplary communication network where a call is received at a device from a first party device, in accordance with various embodiments of the invention function;

FIG. 36 illustrates yet another exemplary communication network in which an IVR is displayed when a call is received at a device, in accordance with an embodiment of the invention;

FIG. 37 illustrates an exemplary visual IVR menu along with one or more communication options at a device, in accordance with an embodiment of the invention;

FIG. 38 illustrates another exemplary visual IVR menu along with one or more communication options at a device, in accordance with an embodiment of the invention;

FIG. 39 illustrates the presentation of the visual IVR menu when a phone connection is associated with a wide band internet 'smart' modem;

FIG. 40 illustrates a flowchart for providing enhanced telephony when a call is received, in accordance with an embodiment of the invention;

FIG. 41 illustrates an environment where a device may be connected to an external device, according to an embodiment of the invention;

FIG. 42 illustrates exemplary functioning of the device (portable device) in the environment of FIG. 41, in accordance with an embodiment of the invention;

FIG. 43 illustrates exemplary functioning of the portable device such as a smart phone connected to a laptop in the environment of FIG. 41, in accordance with another embodiment of

FIG. 44 illustrates exemplary functioning of the portable device connected to a large display screen in the environment of FIG. 41, in accordance with another embodiment of the invention;

FIG. 45 illustrates exemplary functioning of the portable device such as the smart phone connected to a television screen in the environment of FIG. 41, in accordance with another embodiment of the invention;

FIG. 46 illustrates exemplary functioning of the portable device connected to a picture frame in the environment of FIG. 41, in accordance with another embodiment of the invention;

FIG. 47 illustrates exemplary functioning of the portable device connected to a Global Positioning System (GPS) navigation system in the environment of FIG. 41, in accordance with another embodiment of the invention;

FIG. 48 illustrates exemplary functioning of the portable device such as the smart phone connected to a projector in the environment of FIG. 41, in accordance with another embodiment of the invention;

FIG. 49 illustrates exemplary display of an Interactive Voice Response (IVR) menu on a large display screen connected to a portable device such as the smart phone, in accordance with an embodiment of the invention;

FIG. 50 illustrates block diagram of the portable device, in accordance with an embodiment of the invention;

FIG. 51 illustrates another block diagram of the portable device, in accordance with an embodiment of the invention;

FIG. 52 illustrates an environment where a portable device may be connected to a user device, in accordance with an embodiment of the invention;

FIG. 53 illustrates an environment where a portable device may be connected to a user device, in accordance with another embodiment of the invention;

FIG. 54 illustrates exemplary functioning of the portable device connected to a mobile phone in the environment of FIG. 52 or FIG. 53, in accordance with an embodiment of the invention;

FIG. 55 illustrates exemplary functioning of the portable device connected to a mobile phone and a projector in the environment of FIG. 52 or FIG. 53, in accordance with another embodiment of the invention;

FIG. 56 illustrates another exemplary functioning of the portable device connected to a mobile phone and a large screen in the environment of FIG. 52 or FIG. 53, in accordance with another embodiment of the invention;

FIG. 57 illustrates another exemplary functioning of the portable device connected to a mobile phone and a television in the environment of FIG. 52 or FIG. 53, in accordance with another embodiment of the invention;

FIG. 58 illustrates exemplary functioning of the portable device connected to a mobile phone and a laptop in the environment of FIG. 52 or FIG. 53, in accordance with another embodiment of the invention;

FIG. 59 illustrates another exemplary functioning of the portable device connected to a picture frame and a wired telephone in the environment of FIG. 52 or FIG. 53, in accordance with another embodiment of the invention;

FIG. 60 illustrates exemplary functioning of the portable device connected to a mobile phone and a GPS navigation system in the environment of FIG. 52 or FIG. 53, in accordance with another embodiment of the invention;

FIG. 61 illustrates an exemplary display of an Interactive Voice Response menu (IVR) on a large display screen connected to a portable device and a user device such as smart phone, in accordance with an embodiment of the invention;

FIG. 62 illustrates a block diagram of portable device 5202, in accordance with an embodiment of the invention;

FIG. 63 is a flowchart illustrating the functioning of portable device 4102, in accordance with an embodiment of the invention;

FIGS. 64A and 64B illustrates a flowchart for implementing the portable device in the environment of FIG. 52 and FIG. 53, in accordance with an embodiment of the invention;

FIG. 65 illustrates an exemplary functioning of Visuphone for displaying one or more contact options at a device, in accordance with an embodiment of the invention;

FIG. 66 illustrates change of display at user device 102, when a user selects a contact option, in accordance with an embodiment of the invention;

FIG. 67 illustrates an exemplary functioning of Visuphone for displaying one or more contact options at a device, in accordance with another embodiment of the invention;

FIG. 68 illustrates change in display at device 102 based on selection of a contact option by a user of device 102, in accordance with an embodiment of the invention; and

FIG. 69 illustrates a flow diagram illustrating an exemplary functioning of the Visuphone for displaying one or more contact options at a device, in accordance with an embodiment of the invention.

DETAILED DESCRIPTION OF THE INVENTION

Illustrative embodiments of the invention now will be described more fully hereinafter with reference to the accompanying drawings, in which some, but not all embodiments of the invention are shown. Indeed, the invention may be embodied in many different forms and should not be construed as limited to the embodiments set forth herein; rather, these

embodiments are provided so that this disclosure will satisfy applicable legal requirements. Like numbers refer to like elements throughout.

FIG. 1A illustrates an exemplary environment where various embodiments of the invention may function. A device 102a can be used by a caller 106 for connecting to destinations 108a-n. Device 102a can be a telecommunication device that can connect directly to a Public Switched Telephone Network (PSTN) 110. A person skilled in the art will appreciate, that device 102a can also connect to a private telephone exchange. Examples of device 102a include, but not limited to, a mobile phone, a Smartphone, a telephone, or any other device capable of voice or data communication. Each of destinations 108a-n may include one or more Interactive Voice Response (IVR) menus. Further, each of destinations 108a-n may have one or more associated phone numbers. When caller 106 dials a phone number of a destination and connects to any destination from destinations 108a-n, an audible IVR menu may be played to caller 106. Each of destinations 108a-n can have different and more than one audible IVR menus. For example, IVR menus of bank may be completely different from that of a hospital. Typically, the audible IVR menu provided by destinations 108a-n comprises audible options or instructions. Caller 106 may be required to select various options from the audible IVR menu to obtain the required information or resource or service from the dialed destination. Various types of destinations 108a-n that implement the audible IVR menu include, for example, banks, hotels, fast-food outlets, utility services providers, corporate offices, and so forth.

In an embodiment, device 102a includes a Visuphone 104 that can display a visual IVR menu on device 102a corresponding to the audible IVR menu based on a phone number of the destination to be connected. Visuphone 104 may be hardware, an application stored as software, a firmware on device 102a, or a combination thereof. Thereafter, caller 106 can select the options of the audible IVR menu from the visual display without the requirement to listen to the audible instructions. Further, Visuphone 104 may display one or more options based on the dialed destination. Exemplary audible IVR menu at destination 108a and a corresponding visual IVR menu are explained in detail in conjunction with FIGS. 2A and 2B.

In an embodiment of the invention, device 102a can request for updates from a server through a communication network. The server may maintain the updated information of destinations and their associated properties. This may happen in a case when requested information is not available on the dialed destination. The communication network can include more than one device. Examples of the communication network include, but are not limited to, the Network, PSTN, Local Area Network (LAN), Wide Area Network (WAN), and so forth.

FIG. 1B illustrates another exemplary environment where various embodiments of the invention may function. As shown, device 102b can be a device that can be connected directly to a network 112. Examples of device 102b include, but are not limited to, a personal computer, a laptop, a mobile phone, a smart-phone, a fixed line telephone, Voice Over Internet Protocol (VOIP) phone or other devices capable of voice or data communication. Device 102b may include various applications or computer programs that enable caller 106 to use device 102b for connecting to any of destinations 108a-n through PSTN 110 over network 112. For example, the applications may be VOIP applications, such as but not limited to, Skype, Magic Jack, Google Talk and so forth. A gateway 116 can be used to interconnect PSTN 110 and

13

network 112. Network 112 may include any wired or wireless network. Examples of network 112 include, but are not limited to, a Local Area Network (LAN), a Wide Area Network (WAN), a Wi-Fi network, and so forth. As discussed with reference to FIG. 1A, destinations 108a-n can present the audible IVR to caller 106. Device 102b includes Visuphone 104b that displays a visual IVR menu on device 102b corresponding to the audible IVR menu based on a phone number of the destination to be connected. Further, Visuphone 104 may display one or more options for communication on device 102b.

FIG. 1C illustrates yet another exemplary environment where various embodiments of the invention may function. As shown, device 102c can be connected to PSTN 110 through network 112 or through the cellular network 111. Various service providers provide multiple or overlapping services to customers. For example, cable television service provider may also provide phone and Internet service, optical Internet provider may also provide phone or television services, WiMax service providers that provide phone service, and so forth. Network 112 may be any service provider that provides such services, for example, but not limited to, cell phone services, wireless services, Internet services, cable television services, or various combinations of the above or other type of services. As discussed with reference to FIG. 1A, destinations 108a-n presents the audible IVR to caller 106. Device 102c includes Visuphone 104 that displays a visual IVR menu on device 102b corresponding to the audible IVR menu based on a phone number of the destination to be connected. Further, Visuphone 104 may display other communication options to caller 106.

In an embodiment of the invention, Visuphone 104 may call the dialed destination based on the predefined calling information automatically. In an embodiment, Visuphone 104 may keep on calling to the dialed destination until the requested information is received. In an embodiment, the dialed destination may request the information requested by Visuphone 104 of device 102c (or 102a or 102b), from a server of the communication network. Thereafter, the dialed destination may send the information received from the server to Visuphone 104 of device 102c. Further, Visuphone 104 may save and/or display the received information at device 102c.

FIG. 2A illustrates an exemplary audible IVR menu 222a at destination 108a, in accordance with an embodiment of an invention. A person skilled in the art will appreciate that audible IVR menu 222a is an exemplary graphical representation of the audible instructions presented by destination 108a for the sake of explanation and is not an actual graphical display. For explanation, assuming that destination 108a is a pizzeria that provides home delivery and takes away services. Caller 106 connects to destination 108a by dialing a board phone number 202a. Subsequently, various options of audible IVR menu 222a are played to caller 106. The various options include an option 204a that plays an audible instruction, "press 2 for pizza order", an option 206a that plays an audible instruction, "press 3 for order status", an option 220a that plays an audible instruction, "press 0 for main menu". Caller 106 can select an option by pressing from device 102, a button corresponding to the instructions in the audible IVR menu. Subsequently, the selected options are transmitted to the destination and the menu is advanced if there are any further options. Alternatively the display can present the next layer of menu options to give the caller better view of the option domain and allow even faster interface between caller and the IVR.

14

For example, selection of option 204a presents an option 208a that plays an audible instruction, "press 1 for veg" and an option 210a that plays an audible instruction, "press 2 for non-veg" is played. Similarly, selecting option 208a or 210a presents or option 214a that plays an audible instruction, "press 1 for home delivery", an option 216a that plays an audible instruction, "press 2 for take away". Similarly, selection of option 206a presents an option 212a that plays an audible instruction, "press 1 to talk to an executive".

Options 204a, 206a, 208a, 210a, 212a, 214a, and 216a are part of a main menu 218a. Main menu 218a can be repeated by selecting option 220a by caller 106. Caller 106 may repeat main menu 218a for example, in case of a mistake in selection. Therefore, caller 106 directly interacting with audible IVR menu 222a may be required to listen to all or various audible options before executing a desired action. However, the interaction is simplified by Visuphone 104, that presents a visual IVR menu 222b to caller 106 corresponding to audible IVR menu 222a, as explained with reference to FIG. 2B.

Further, each of destinations 108a-n may have more than one audio IVR menus. Therefore, different visual IVR menus corresponding to one or more audio IVR menus can be available for each of destinations 108a-n. In an embodiment, device 102 may include more than one visual IVR menus for each destination of destinations 108a-n based on the time. Herein after device 102 collectively refers to device 102a, 102b and 102c. Therefore, different visual IVR menus corresponding to a destination 108 might be presented to caller 106 depending on the time of dialing to destination 108.

In an exemplary scenario, in a hotel, the food items in a daytime menu card may be different from a night menu card. Accordingly, the options in the visual IVR menu may differ. Therefore, the visual IVR menus for daytime and night can be different for the hotel. When caller 106 dials the phone number of the hotel in daytime, a daytime visual IVR menu can be displayed at device 102a, and if caller 106 calls at night, a different menu can be displayed at device 102a. Therefore, a visual IVR menu of the hotel displayed at the calling device for a call made at noon may be different then the visual IVR menu displayed for another call made at evening.

FIG. 2B illustrates an exemplary visual IVR menu 222b corresponding to an audible IVR menu 222a, in accordance with an embodiment of the invention. Visual IVR menu 222b may be displayed on a screen of device 102b that may connect to destination 108a through network 112 and PSTN 110. In an embodiment, visual IVR menu 222b can be displayed before a connection is established with destination 108a. A person skilled in the art will appreciate that device 102b is illustrated for the sake of explanation, and similar visual IVR menu 222b can be displayed on device 102a that connects to destination 108a directly through PSTN 110. Visual IVR menu 222b includes various nodes corresponding to the options of an audible IVR menu of destination 108a. The various nodes of visual IVR menu 222b include a node 202b for connecting to board number 202a of destination 108a. Similarly, nodes 204b, 206b, 208b, 210b, 212b, 216b corresponds to option 204a, 206a, 208a, 210a, 212a, 216a respectively. A node corresponding to option 220a may not be required in visual IVR menu 222b, as the complete menu is visible and caller 106 may not be required to repeat audible IVR menu 222a. Therefore, when caller 106 selects a node from visual IVR menu 222b, Visuphone 104 automatically transmits the desired action corresponding to the options in audible IVR menu 222a to dialed destination 108a. For example, assuming that caller 106 calls destination 108a to order a veg pizza for home delivery. In this case, caller 106 directly selects nodes 208b and 214b from a touch screen of device 102a,

15

corresponding to veg pizza and home delivery from visual IVR menu **222b**. Alternatively, caller **106** directly selects nodes **204b**, **208b** and **214b** by pressing corresponding keys '2', '1', and from a keypad or screen of device **102a** without a need to listen to the complete audible IVR menu. Visuphone **104** accordingly transmits the signals to audible IVR menu **222a**. In this case, the signals required by audible IVR menu **222a** may be the Dual Tone Multi-Frequency (DTMF) tones of '2', '2', and '1' for options **204a**, **208a**, and **214a**. Moreover, caller **106** may not be required to select all the options. For example, when caller **106** wants to order a veg-pizza for take away. Then, only the nodes **208b** and **216b** may be required to be selected, and node **204b** is automatically understood by Visuphone **104b**. Furthermore, a node that is necessary for a transaction is automatically highlighted. For example, if caller **106** only selects node **216b** for take away, then node **208b** for a veg-pizza or node **210b** for non-veg are highlighted for selection. In an embodiment of the invention, caller **106** may select nodes irrespective of the sequence presented in the audible IVR menu. For example, node **214b** for home delivery may be selected before node **208b** of veg-pizza. Visuphone **104** automatically generates a sequence of the selections made by caller **106** and transmits it to the destination. Furthermore, Visuphone **104** stores the selections and the numbers dialed by the caller during the call in association with the destination phone number. In an embodiment, Visuphone **104** may enable callers to search or bookmark options in a menu with a large number of options. For example, callers can search for a node **214b** from the menu by typing 'home delivery'. As a result, navigation of a complete visual IVR menu may not be required.

In an embodiment of the invention, visual IVR menu **222b** is displayed to caller **106** when a call is received at device **102** from a destination of destinations **108a-n**. For example, a service provider may call to provide information about new services or account of caller **106**. Further, caller **106** may be required to select various options based on his preferences. Visuphone **104b** may detect the received number and correspondingly display a visual IVR menu to the caller. Further, the calling destination may push or send the visual IVR menu associated with the destination to device **102a** (**102b** or **102c**). The process of displaying visual IVR menu when a call is received at the device is explained in detail in FIG. **35** to FIG. **40**.

FIG. **2C** illustrates an exemplary visual IVR menu **222c** with added graphics for the nodes. It is well known that graphics are easier to learn and are faster to recognize than words. Therefore, graphics are used in various computerized device interfaces. The exemplary graphics as shown with reference to FIG. **2C** are icons. Various other types of graphics can be displayed for example, animated icons, icons that highlight or animate when the node is highlighted, and so forth.

In an embodiment, the graphics may be displayed for each node or a few nodes based on the usability of visual IVR menu **222c**. For example, for the node **208** an icon of a vegetable may be displayed to designate a vegetarian pizza, and an icon of house for the node **214c** of home delivery may be displayed. In an embodiment of the invention, visual IVR menu **222c** can be customized to display only the text, only the icons or both. Furthermore, caller **106** can suggest or use various icons based on his preferences.

FIG. **2D** illustrate an exemplary tooltip that is displayed when a cursor is hovered over an option in the visual IVR menu. As shown, a tooltip box **222** is displayed when a cursor **226** is hovered on option **204c** or **206c**. Similarly, a Tooltip box **224** may be displayed containing the next menu text with

16

or without it's available options **210c**, **208c** in case the caller decides to select the option over which cursor **226** is hovered, for example option **204c**.

In an embodiment of the invention, Visuphone **104b** may provide a standard menu per group of similar audible IVR or destinations. With reference to FIG. **2B**, an example of a menu at a pizza provider is discussed. Generally, every pizza provider may have its specific audible IVR menu. However, caller **106** may prefer to use a single standard visual IVR menu for all pizza providers. Therefore, learning a single visual IVR menu will be useful for engaging various providers. In such a case, the database may include a standard menu per class of compatible providers. Visuphone **104** may offer caller **106** an option to use the standard domain menu. Therefore, when caller **106** makes a selection on the standard menu, Visuphone **104** may translate the selection to the specific audible IVR menu selection and send the proper dialing tones (or DTMF) to that specific audible IVR. Furthermore, the standard menus may be published. Therefore, various providers may modify their own menus to help their customers. Additional aspect of the standard menu is the use of icons as discussed with reference to FIG. **2C**. The icons may represent standard choice across various domains. For example, if a specific icon may represent sales, then the same icon may be used for sales of airlines tickets when the destination is an airline company or sales of telephone service when the destination is a telephone company. In an embodiment of the invention, the caller may customize the icons or graphics displayed on the menu.

FIG. **3** illustrates exemplary components of device **102a** for implementing Visuphone **104**. Device **102a** includes a system bus **324** to connect the various components. Structures of system bus **324** include several types of bus structures including a memory bus or memory controller, a peripheral bus, or a local bus using any of a variety of bus architectures. As discussed with reference to FIG. **1A**, device **102a** can be a device such as computer, a smart-phone and so forth. Device **102a** can connect to PSTN **110** through a gateway **326**, which is connected to network **112** through a network interface **314**. Input/Output (IO) interface **316** of device **102a** may be configured to connect external or peripheral devices such as a memory card **318**, a keyboard **320a**, a mouse **320b** and a Universal Serial Bus (USB) device **322**. Although not shown, various other devices can be connected through IO interface **316** to device **102a**. In an embodiment of the invention, device **102a** may be connected to a hub that provides various services such as voice communication, Internet access, television services, and so forth. For example, the hub may be a Home Gateway device that acts as a hub between the home environment and the Broadband Network.

Device **102a** includes a display **302** to output graphical information to caller **106**. In an embodiment of the invention, display **302** may includes a touch sensitive screen. Therefore, caller **106** can provide inputs to device **102a** by touching display **302** or by point and click using the 'mouse'. Memory **306** of device **102a** stores various programs, data and/or instructions that can be executed by a Central Processing Unit (CPU) **304**. Examples of memory **306** include, but are not limited to, a Random Access Memory (RAM), a Read Only Memory (ROM), a hard disk, and so forth. A person skilled in the art will appreciate that other types of computer-readable media which can store data that is accessible by a computer, such as magnetic cassettes, flash memory cards, digital video disks, and the like, may also be used by device **102a**. Memory **306** may include Operating System (OS) (not shown) for device **102a** to function. Further, memory **306** may include other applications **310** that enable the caller to communicate

with destinations. Examples of other applications **310** include, but are not limited to, Skype, Google Talk, Magic Jack, and so forth. Other applications **310** may be stored as software or firmware on device **102a**.

Further, memory **306** includes Visuphone **104** for presenting a visual IVR menu corresponding to the audible IVR menu of destination as discussed with reference to FIGS. 2A, 2B and 2C. Visuphone **104** may be an application stored as a software or firmware on device **102a**. The visual IVR menus are stored in a visual menu database **308** in memory **306** of device **102a**. Visuphone **104** searches visual menu database **308** for visual IVR menus corresponding to a phone number of destinations **108a-n** dialed by caller **106**. In an embodiment, Visuphone **104** searches visual menu database **308** for visual IVR menus corresponding to a phone number of a calling destination. Subsequently, if the visual IVR menu for the phone number is available in the database, then the visual IVR menu is displayed on display **302**. Further, Visuphone **104** may be implemented as a plug-in to other applications **310**. Therefore, when a phone number is dialed from other applications **310**, Visuphone **104** detects the dialing of the number and automatically displays the visual IVR menu corresponding to the phone number. Thereafter, the caller can interact with the visual IVR menu, without listening to the complete audible IVR menu of destinations.

With reference to FIG. 4, an exemplary display of a visual IVR menu **406** on device **102c** is illustrated. The caller may dial a phone number **402** corresponding to a destination using keypad **320**. Keypad **320** may be a physical keypad or a virtual keypad displayed on a touch screen display **412**. Subsequently, visual IVR menu **406** corresponding to phone number **402** is searched and displayed on a display **412**.

In an exemplary instance, if caller dials a phone number of an IVR destination, then a visual IVR menu corresponding to audible IVR menu of the dialed destination is displayed on display **412**. Similarly, if the caller receives a call from a phone number of destination, then a visual IVR menu corresponding to audible IVR menu of destination is displayed on display **412**. Thereafter, caller can interact with the visual IVR menu to select options from the audible IVR menu. Visual IVR menu **406** may be displayed before actual connection of device **102c** to destinations. Therefore, caller can select a desired action from visual IVR menu **406** before connecting to destinations. In an embodiment of the invention, visual IVR menu **406** may be provided in real-time to caller. In an embodiment of the invention, visual IVR menu **406** is provided a messaging service such as a Short Messaging Service (SMS). Therefore, destinations may provide customized visual IVR menu **406** to caller **106**. Visual IVR menu **406** may be customized based on the profile of caller. In an embodiment of the invention, the profile may be generated based on access pattern of caller or the data capture by a hub connected to device **102c**.

Caller can interact with visual IVR menu **406** by pressing a desired button from keypad **320**. For example, caller can press a '5' key from keypad **320** to select a node **5** in visual IVR menu **406**. Further, caller can directly select the node **5** of visual IVR menu **406** from display **412**, in case of a touch sensitive screen. Depending on the complexity or size of destinations, visual IVR menu **406** may have various nodes. Moreover, display area of display **412** may be limited or small. As a result, all the nodes of visual IVR menu **406** may not be displayed together on display **412**. In such a case, Visuphone **104** is configured to allow caller to navigate by scrolling horizontally and/or vertically to view nodes on visual IVR menu **406**. Further, Visuphone **104** may detect the capability of device **102a** before displaying the visual IVR

menu. For example, in case device **102a** is a basic mobile phone with limited functionality of the display screen. Therefore, Visuphone **104** may display the visual IVR menu in form of a simple list. Similarly, a list may be displayed in case of fixed line telephones. Moreover, in case device **102c** includes a high capability screen, such as but not limited to an iPhone, then the visual IVR menu is displayed in form of graphics.

Subsequently, after caller selects a desired action from visual IVR menu **406**, a connection is established between device **102c** and destinations based on the selected option. In one embodiment, Visuphone **104** is configured to detect and present an application or computer program available on device **102c**.

In an embodiment, Visuphone **104** may be configured to display an advertisement **408**. Advertisement **408** may correspond to the type of services provided by the dialed destinations. For example, if destination dialed is a pizzeria, then advertisement **408** may include promotions or offers about a new pizza. Moreover, advertisement **408** may include promotions or offers from a third party or a competitor of the destination. Further, Visuphone **104** may be coupled to an advertising database. The advertising database may include advertisements related to the phone numbers of the destinations. The advertising database may be stored at device **102c**, the destinations, service providers or other third party servers. Further, the advertisements may be provided based on a profile of caller. For example, assuming that the caller calls a bank holding his saving account. Therefore, the advertisement displayed to the caller may be based on the location, address, account balance, type and volume of transactions, loans, purchases and so forth.

Visuphone **104** may be configured to connect to an intended destination, when caller selects advertisement **408**. Further, Visuphone **104** may display visual IVR menu **406** of the intended destination. In an embodiment, Visuphone **104** may store the interactions of caller with visual IVR menus. For example, Visuphone **104** may automatically learn the numbers dialed or options selected from the menu. Moreover, the learned numbers or choices are associated with the dialed phone number of the destination. Therefore, the caller is assisted in his future calls. For example, when caller calls the destination again, then the actions that were performed in the last interaction are presented prominently to caller; or a previous sequence may be automatically performed. Further, the actions that are frequently performed are presented prominently to the caller. For example, if caller dials a bank frequently to enquire about his account balance, then the options for selecting his account balance may be highlighted.

In an embodiment, Visuphone **104** may display a visual IVR menu associated with the dialed destination. In an embodiment, Visuphone **104** may display a mode option on a screen of device **102**. The mode option may be selected by a caller such as caller **106** for switching the mode of device **102**. Based on the selected mode of device **102**, one or more input or output options may be displayed on the screen. Example of the one or more input or output options include, but are not limited to, a date of making a call, a time of making a call, a predefined time interval for repeating a call, and so forth.

In an embodiment of the invention, the mode option is a scheduling mode option. Caller **106** may switch device **102** to a scheduling mode by selecting the mode option. In an embodiment, when device **102** is in scheduling mode, Visuphone **104** may save the inputs from caller **106**. In an embodiment, Visuphone **104** may save the options of the displayed visual IVR menu selected by caller **106**. In the scheduling mode, Visuphone **104** may display one or more input options on the screen to enter a call schedule including a date and a

time information. In an embodiment, Visuphone **104** may further ask caller **106** to enter other important information required for dialing the phone number of the destination automatically at a later time. Thereafter, caller **106** may enter the date and time information for dialing the phone number of the destination. Furthermore, Visuphone **104** may call a phone number of a destination of destinations **108a-n** automatically based on the predefined calling information. The predefined calling information can be entered by caller **106**. The predefined calling information may include the selection information and the call schedule. The selection information may include one or more options of the displayed visual IVR menu associated with the dialed destination, selected by caller **106**.

In an embodiment of the invention, Visuphone **104** may establish a communication with the dialed destination based on the predefined calling information. Further, Visuphone **104** may request information from the dialed destination based on the predefined calling information. Furthermore, Visuphone **104** may receive the requested information from the dialed destination based on the predefined calling information. In an embodiment, caller **106** may also interact with the dialed destination after establishment of the communication. Furthermore, Visuphone **104** may save the received information at device **102**. In an embodiment, Visuphone **104** may convert the format of the received information from a first format to a second format. In an embodiment, the first format of the received information may be an audio format. Examples of the audio format include, but are not limited to, WAV, Real Audio, Musical Instrument Digital Interface (MIDI), Windows Media Audio (WMA), MP3, Ogg, and so forth. In an embodiment, the second format may be a text format such as a Unicode text, Rich Text format, HyperText Markup Language (HTML) or any other format compatible with device **102a**. In an embodiment, Visuphone **104** may display the received information at device **102a**.

FIG. **5** illustrates exemplary components of device **102b** for implementing Visuphone **104**, in accordance with another embodiment of the invention. Device **102b** includes a system bus **526** to connect the various components. Examples of system bus **526** include several types of bus structures such as, but not limited to, a memory bus or memory controller, a peripheral bus, or a local bus using any of a variety of bus architectures. As discussed with reference to FIG. **1B**, device **102b** can be a computing device such as, but not limited to, a personal computer, a laptop, a mobile phone, a smart-phone, and so forth. Device **102b** can connect to network **112** through a network interface **514**. Further, device **102b** can connect to PSTN **110** through gateway **116** and network **112** through network interface **514**. Input/Output (IO) interface **516** of device **102b** may be configured to connect external or peripheral devices such as a mouse **518**, a keyboard **520**, a speaker **522**, microphone **523**, and a camera **524**. Although not shown, various other devices such as hard disk, a Universal Serial Bus (USB) device or others can be connected through IO interface **516** to device **102b**. A person skilled in the art will appreciate that although not described, various other types of devices capable of voice and/or data communication can be connected to device **102b**.

Device **102b** includes a display interface **502** to connect to a display **512**. Display interface **502** can be for example, a video adapter. Display **512** outputs graphical information to caller. In an embodiment of the invention, display **512** includes a touch sensitive screen. Therefore, caller **106** can provide inputs to device **102b** by touching display **512** or by pointing with the mouse and click. Memory **506** of device **102b** stores various programs, data and/or instructions that

can be executed by Central Processing Unit (CPU) **504**. Examples of memory **506** include, but are not limited to, a Random Access Memory (RAM), a Read Only Memory (ROM), a hard disk, and so forth. A person skilled in the art will appreciate that other types of computer-readable media which can store data that is accessible by a computer, such as magnetic cassettes, flash memory cards, digital video disks, and the like, may also be used by device **102b**. Memory **506** may include Operating System (OS) (not shown) for device **102b** to function. Further, memory **506** may include other applications **510** that enable caller **106** to communicate with destinations **108a-n**. Examples of other applications **510** include, but are not limited to, Skype, Google Talk, Magic Jack, and so forth. Other applications **510** may be stored as software or firmware on device **102b**. Further, memory **506** includes Visuphone **104** for searching and presenting a visual IVR menu corresponding to the audible IVR menu of a destination as discussed with reference to FIGS. **2A** and **2B**. Visuphone **104** may be an application stored as a software or firmware on device **102b**. The visual IVR menus are stored in visual menu database **308** in memory **506** of device **102b**. Visuphone **104** searches visual menu database **308** for visual IVR menu corresponding to a phone number of a destination dialed by caller **106**. Subsequently, the visual IVR menu is presented on display **512** for selection of options by caller **106**. Further, Visuphone **104** may be implemented as plug-in to other applications **510**. Therefore, when a phone number is dialed from other applications **510**, Visuphone **104** detects the dialing and automatically searches and displays the visual IVR menu corresponding to the dialed phone number. Thereafter, caller **106** can interact with the visual IVR menu, without listening to the audible IVR menu of destinations **108a-n**.

FIG. **6** illustrates an exemplary display of a visual IVR menu **604** on device **102b**, in accordance with an embodiment of an invention. Caller **106** may dial a phone number **610** from a VOIP application **608** on device **102b**. Phone number **610** may correspond to any of destinations **108a-n**. In an embodiment, caller selects a pre-stored phone number from the application **608**. Subsequently, visual IVR menu **604** corresponding to a dialed destination is displayed on display **512**. In an embodiment, display **512** may comprise a touch sensitive screen. Therefore, caller **106** can interact with device **102b** directly through display **512**.

In an exemplary instance, if caller **106** dials a phone number of destination, then a visual IVR menu corresponding to audible IVR menu of destination is displayed. Thereafter, caller **106** can interact with the visual IVR menu to select options and to transmit inputs for the audible IVR menu of the corresponding destination. Visual IVR menu **604** could be displayed before actual connection of device **102b** to destinations. Therefore, caller **106** can select a desired option from visual IVR menu **604** before establishing a connection to the dialed destination. Depending on the complexity or size of the destinations, visual IVR menu **604** may have various nodes. For example, an organization with 50 departments may have more menu options or nodes than that of an organization with 10 departments. Further, the display area of display **512** may be limited. As a result, all the nodes of visual IVR menu **604** may not be displayed together on display **512**. In such a case, Visuphone **104** is configured to allow caller **106** to navigate by scrolling horizontally and/or vertically to view nodes on visual IVR menu **604**. Moreover, caller **106** can search for a desired option from the visual IVR menu.

Subsequently, after caller **106** selects a desired option from visual IVR menu **604**, a connection is established between device **102b** and a destination based on the selected action. In one embodiment, Visuphone **104** is configured to detect and

present applications suitable to caller **106** for initiating the connection. For example, Visuphone **104** may detect more than one VOIP applications present in device **102b** and present them to caller **106** on display **512**. Thereafter, caller **106** can select an application to be used or initiate the connection in a default configuration. The default configuration can be for example, VOIP application **608** on which phone number **610** was dialed. In another embodiment, caller **610** may select a phone number displayed in applications such as a browser, messenger, or a mail client. Subsequently, Visuphone **104** detects and presents applications suitable to caller **106** for initiating the connection. Furthermore, Visuphone **104** is configured to display visual IVR menu **604** for the phone number selected from the applications. Further, one or more options such as file, edit, new, and so forth may be displayed in field **602** as shown.

In an embodiment, Visuphone **104** is further configured to display an advertisement **606**. Advertisement **606** may correspond to the type of services provided by destinations. For example, if the destination is a bank, then advertisement **606** may include promotions or offers about new loans or schemes. Moreover, advertisement **606** may include promotions or offers from a third party or a competitor of destination. Visuphone **104** may be configured to connect to intended destination, when caller selects advertisement **606**. Further, Visuphone **104** displays visual IVR menu **606** of the intended destination. In an embodiment, Visuphone **104** stores the interactions of caller with visual IVR menus after a call to an IVR was made. Therefore, when caller calls the same destination again, then the options that were selected in the last interaction are presented prominently. Further, the options that are frequently selected can be presented prominently. For example, if caller dials a bank frequently to check his account balance, then the options for selecting his account balance may be highlighted. Additionally the information such his account number can be brought up to save effort for the caller who can than just OK for that 'auto fill' to be dialed out to the IVR at the proper time.

As illustrated in FIG. 7, device **102b** may include a web browser **702** to display web pages from the Internet and/or other computer networks. Various websites provide a phone number on the web pages as a click-to-talk button. The clickable button can provide, for example, a contact number of executives of the organization. The clickable button may be programmed to display a phone number of the organization and/or display a caller a form to provide his contact details, so that an executive from the organization can call back the caller. Visuphone **104** is configured to detect a connect button **706** on a webpage **704**. Connect button **706** may be used by Visuphone **104** to initiate a connection to a destination **108**.

Thereafter, Visuphone **104** can detect and launch a VOIP application on device **102b**. In an embodiment, in case more than one application is available on device **102**, Visuphone **104** selects a VOIP application preferred by caller. Moreover, Visuphone **104** may be configured to automatically login into the VOIP application. In an embodiment, caller **106** stores the login details for the VOIP application in Visuphone **104**. Further, Visuphone **104** displays a visual IVR menu corresponding to audible IVR menu of the destination connected once click on connect **706** tab. Therefore, caller **106** can connect to the destination from web browser **702** automatically and may not be required to dial the phone number or provide call-back information.

In an embodiment of the invention, Visuphone **104** may include a VOIP plug-in that monitors the outgoing calls made from the VOIP application. Therefore, the VOIP plug-in may search each dialed number in visual menu database **308**. In

case, the dialed number is found in visual menu database **308** and is associated with an IVR, then the VOIP plug-in may display the visual IVR menu corresponding to the audible IVR menu of the dialed number.

Another embodiment of the invention allows the caller to select the visual IVR menu using car display like GPS display. Hands-free cell phone system is used in many cars as a separated device or as an integrated system in the car. These devices allow the caller to talk with the cell phone without holding the cell phone in his hands. Some devices are using the car speakers for the phone call. In many cases, the hands-free system can use a display screen in the car like GPS screen or other display. Following voice menu while driving might not be the optimal way to use hands-free cell phone system. In some cases, selecting an option from a visual IVR menu is preferred. While driving or stopping in red light, it might be easier to use larger display like the GPS display in the car. The display can present the visual IVR menu and the caller can select the option from the menu. The computing engine to support the visual IVR menu could be embedded in the car GPS system or in another controller that have access to the car display. Once the system recognizes a destination of a call to be an IVR it will access the database pull out the menu and display. Accordingly all the other Visuphone features could be incorporated.

FIG. 8 illustrates exemplary software architecture **800** of Visuphone **104**, in accordance with an embodiment of the invention. A hardware layer **802** includes various hardware of device. For example, but not limited to, a mouse, a keyboard, a speaker, a microphone, a camera, a USB device, a display, and so forth. The drivers or files required for proper functioning or installation of the hardware of device are provided by a drivers layer **804**. Moreover, drivers layer **802** interfaces with an Operating System **806**.

Operating System **806** provides memory and environment required by Visuphone **104** and other applications **808** for functioning on device. Examples of Operating System **806** include, but are not limited to, Windows, Macintosh, Linux, Symbian, Andriod, and so forth. Visuphone **104** may be implemented as a plug-in to other applications **808**, such as Skype, Google Talk, web browser, mail client, and so forth. In an embodiment, Visuphone **104** may be implemented as a standalone application on device. Further, Visuphone **104** may be configured to execute as a background application. Therefore, caller **106** may not be required to specifically launch Visuphone **104**. Furthermore, Visuphone **104** may be implemented as a multi-threaded application. Therefore, visual IVR menus of more than one destination may be displayed simultaneously on device.

FIG. 9 illustrates exemplary components of Visuphone **104**, in accordance with an embodiment of the invention. As discussed above, Visuphone **104** may be implemented as hardware, software, or firmware on device **102**. Further, Visuphone **104** may be configured to execute as a background process on device. In an embodiment, Visuphone **104** may be configured to execute as a system service. Therefore, other processes or applications executing on the device may not block the operation of Visuphone **104**.

When caller **106** dials, selects or receives a phone number on the device, a detection module **902** of Visuphone **104** detects that a phone number has been dialed, selected or received. For example, detection module **902** may detect key presses or caller ID on device. Caller **106** may use a VOIP application on device for dialing the phone number. Moreover, caller **106** may use a mouse to a joystick to select or press icons of numbers displayed on the VOIP application. Further, detection module **902** is configured to identify the

VOIP applications available on device and used by caller. Moreover, detection module **902** may detect the position co-ordinates of the VOIP application on a display of device. For example, in case device includes the Microsoft Windows OS, then the position co-ordinates of the VOIP application can be detected from the registry of the OS. Detection module **902** may be configured to store the position of number icons relative to position co-ordinates of various VOIP applications. Therefore, based on the co-ordinates of the position of the VOIP application, detection module **902** can detect the exact position of each number icon on the display of device. For example, if the co-ordinates of a top-left edge of the VOIP application is (X,Y) on the display, and the co-ordinates of an icon for number '1' on VOIP application is (X1,Y1) relative to its top-left edge, then the exact co-ordinates of the icon for number '1' may be calculated as (X+X1, Y+Y1) on the display. A person skilled in the art will appreciate that other types of mathematical operations can be applied to calculate the co-ordinates of the icons on the display of the device.

Detection module **902** may be configured to detect the co-ordinates of the cursor on the display of device. Further, detection module may be configured to detect the action events generated by the mouse or joystick, such as a click, a double click, a drag, a select, a scroll, and so forth. Therefore, when caller selects or press a number on the VOIP application, detection module **902** may detect the number from the position of the cursor, the VOIP application and the number icon. In an embodiment, detection module **902** may be configured to store the last used co-ordinates of the VOIP application and number icons. Therefore, detection and/or calculation of the co-ordinates may not be required. Furthermore, detection module **902** may be configured to detect a connect button displayed on a web page of a browser on device as explained with reference to FIG. 7. Therefore, when caller clicks the connect button, detection module **902** identifies the phone number behind the connect button. In an embodiment, detection module **902** detects the connect button and the associated phone number by scanning the source code of the web page.

The phone number detected by detection module **902** is used by a search module **904** of Visuphone **104**. In an embodiment, detection module **902** may be configured to transfer each digit to search module **904** in real-time as clicked by caller. Search module **904** searches visual IVR menu database for visual IVR menu corresponding to the phone number. An exemplary visual IVR menu is as explained above in conjunction with FIGS. 2B and 2C. As discussed above, visual IVR menu database stores visual IVR menus corresponding to the audible IVR menus of destinations **108a-n**. Moreover, visual IVR menu database may store other information, which is explained in conjunction with FIG. 10. Search module **904** may also be configured to search for other information in visual IVR menu database. In an embodiment, search module searches visual IVR menu database in real-time based on the digits received from detection module **902**. Therefore, a visual IVR menu may be identified based on the best match of the number formed by the received digits in visual IVR menu database. As a result, caller may not be required to dial, click, press or select the complete number, which may be convenient and time saving.

The visual IVR menu identified by a search module **904** is displayed on the display of device by display module **906** of Visuphone **104**. Display module **906** identifies the position on the display where the visual IVR menu is to be displayed. In an embodiment, the visual IVR menu is displayed such that there is minimum overlap with the VOIP application from which the phone number was dialed or selected. Moreover,

display module **906** identifies the size of the visual IVR menu for display based on the characteristics of the display screen of device. Examples of characteristics of the display screen include, but are not limited to, a screen size, resolution, and so forth. Furthermore, in case the visual IVR menu is not completely displayed on the display, then display module **906** may allow caller to navigate the visual IVR menu by scrolling. Moreover, display module **906** may be configured to display other information received from search module **904**.

Caller **106** may interact with the visual IVR menu or other information displayed on device **102**. For example, caller **102** may scroll through the visual IVR menu, or select a node from the visual IVR menu. Therefore, when caller **106** selects a node from the visual IVR menu, detection module **902** detects the selected node and communicates the selection to a connection module **908**. Thereafter, connection module **908** may establish a connection between device **102** and a destination **108** based on the nodes selected by caller. Connection module **908** may be configured to detect communication systems available in device. For example, in a case, device **102** is a phone not connected to the Internet, connection module **908** may detect that only a radio connection can be made. Otherwise, a most suitable or a connection preferred by caller **106** can be made. In an embodiment, connection module **908** may allow caller **106** to select a VOIP application to establish the connection. In another embodiment, communication module **908** may launch a default VOIP application on device **102**. In yet another embodiment of the invention, connection module **908** can use a VOIP protocol stack defined by Visuphone **104** to establish the connection.

In an embodiment, a call of caller **106** may be transferred from one point in the organization to another point within the same organization or to a completely different organization (or another branch of same organization). For example, a call of caller **106** with destination **108a** may be transferred to destination **108b**. However, destinations **108a** and **108b** may have different audible IVR menus. Connection module **908** is configured to identify the transfer of call and to switch the visual IVR menu of destination **108a** with destination **108b**. The switching of visual IVR menus is explained in detail in conjunction with FIG. 11.

Some organizations such as banks may require caller **106** to present a voice input for the purpose of authentication. For example, caller **106** may be required to voice out his name or an answer to a security question specified by caller **106** to the bank. Furthermore, voice input may be required to accept or decline a transaction. Caller **106** may record and store the voice responses for such authentications or questions alternatively the system can use synthesis voice. Therefore, when connection module **908** detects that a voice authentication is required, and then voice module **910** is used. Voice module **910** provides voice inputs on behalf of caller **106** by using the responses recorded by caller **106**. Subsequently, the connection or the transaction can be processed.

As discussed in conjunction with FIGS. 4 and 6, Visuphone **104** may be configured to display advertisements on device **102**. The advertisements are managed by advertisement module **912** of Visuphone **104**. The advertisement may be selected based on the type of destinations. For example, when a dialed destination is a bank, then an advertisement related to banking may be displayed. Moreover, the advertisement can be related a third-party dealing in the same business or professional area or a competitor of the dialed destination. The displayed advertisement may be a text, audio, image or video. In one embodiment, advertisement module **912** may display the advertisements based on the connection bandwidth available at device **102**. In another embodiment, advertisement

module **912** may display the advertisements based on the pre-set preferences by caller **106**. In one embodiment, advertisement module **912** may be configured to receive the advertisements directly from the dialed destination. In another embodiment, advertisement module **912** may be configured to receive the advertisements from a remote server on a network. The remote server is explained in detail in conjunction with FIG. **10**. A selection or click by caller **106** on advertisements may be detected by detection module **902** to display a visual IVR menu of the destination for which the advertisement was displayed.

In some cases, the audible IVR menu of destination may change. For example, the extension numbers of agents in banks may be changed due to addition of new agents. A person skilled in the art will appreciate that there can be other reasons for the audible IVR menu of a destination to be edited, amended or updated. Further, new organizations may be available that use audible IVR menus. The visual IVR menus for these new organizations may not be available in visual IVR menu database stored on device. Therefore, visual IVR menu database may be required to be updated. In an embodiment, Visuphone may be updated to provide additional functionalities to caller. An update module **914** may be configured to update the visual IVR menus stored in visual IVR menu database of device. Moreover, update module **914** may be configured to update Visuphone. Update module **914** may receive the updated visual IVR menus from the remote server on the network. The remote server is explained in detail in conjunction with FIG. **10**.

Visuphone **104** may record the caller's selections or keystrokes for audible IVR menus by using customization module **916**. The keystrokes may be some personal data of the caller such as his account number, customer number, and so forth. Visuphone can provide better support to caller by presenting the recorded keystrokes so that the caller can approve and sending them without entering them every time. Customization module **916** personalizes the generic visual IVR menu by associating the keystrokes with it and storing in visual menu database **308**. Alternatively, an additional set of standard may be defined for representing caller data. In this case, only the code indicating the type of required data is added to visual menu database **308**. Visuphone **104** can than build a relatively small table in visual menu database **308**, with the various personal data codes and the actual caller data as analyzed from the caller's keystrokes during his connection with destinations of the audible IVR menus.

FIG. **10** illustrates an exemplary remote server **1002** connected to a remote repository **1004**. As shown remote server **1002** is connected to device **102** through a computer network **1006**. Further, remote server **1002** can be connected to destinations **108a-n** through computer network **1006**, a gateway **1008**, and a PSTN **1010**. A person skilled in the art will appreciate that device **102** can connect to destinations **108a-n** directly through PSTN **1010**; therefore the connection is not limited to network **1006**. Each of destinations **108a-n** may be connected to audible IVR menu repository **1012a-n**, here after referred to as destination repository **1012a-n**.

Further, device **102** includes visual menu database **308**. As discussed above, visual menu database **308** includes visual IVR menus corresponding to audible IVR menus of destinations **108a-n**. Moreover, visual menu database **308** may store other information such as profile of caller, voice response of caller, login details for a VOIP application, preferences of caller, ratings for visual IVR menus, identity of visual IVR menus, and so forth. As discussed in conjunction with FIG. **9**, Visuphone **104**, the visual IVR menus or other information stored in visual menu database **308** may require to be updated.

In an embodiment, visual menu database **308** is updated by information received from remote repository **1004**. In another embodiment of the invention, visual menu database **308** may be updated by receiving menus through Short Messaging Service (SMS). The SMS may be sent from destination **108a-n** or remote repository **1004** to device **102**. Remote repository **1004** includes visual IVR menus corresponding to audible IVR menus of destinations **108a-n**. Further, remote repository **1004** stores advertisements related to destinations **108a-n**, last updated time of the visual IVR menus, rating of visual IVR menus, and so forth.

In case, the audible IVR menu of a destination is changed, caller may not be able to connect to the destination by using Visuphone. Visuphone is configured to detect the error generated while establishing the connection. For example, caller may select a node in the visual IVR menu that may not have a corresponding option available in audible IVR menu, or a connection not be established between device **102** and the destination. The error is detected by update module **914** of Visuphone. Subsequently, update module **914** sends an error report to remote server **1002**. Remote server **1002** may check remote repository **1004** for updates related to the visual IVR menu. Thereafter, in case any updates are available, remote server **1002** may send the updates to device **102** for performing the update. In an embodiment, visual menu database **308** may be checked and updated based on a pre-defined time interval by device **102**. In an embodiment, the error report may include the error generated and an Identity (ID) or version of the visual IVR menu on which the error was generated. In case, the updates are not available in remote repository **1004**, then an update of remote repository **1004** may be required.

In an embodiment of the invention, remote repository **1004** is updated based on a pre-defined time interval. In another embodiment of the invention, the caller can rate the relevance or correctness of the visual IVR menu from device **102**. Therefore, remote repository **1004** can be updated based on a cumulative ratings received from callers and other callers of the visual IVR menu. Remote server **1002** can comprise a process of continuously scanning the IVRs **108a** to **108n** updating remote repository **1004** with changes of various IVR menus and adding addition menu records for new IVRs. Also, remote server **1002** might get a 'problem report' from device **102** if caller identify problem between the menus as it is in database **308** and the audible menu of a specific IVR. In such case a recheck process will be initiated to update remote repository **1004** and the new information can be than offered to device **102** for download an update.

In an embodiment, device **102** may send one or more messages or data packets for connection establishment with one of the destinations. Further, Visuphone **104** may detect a data network such as internet for sending data packets. The data network is a network capable of establishing data and voice communication among various communication devices (or devices). In an embodiment, when a data network is not available the one or more messages for establishing connection may be sent using Dual-Tone Multi-Frequency (DTMF) tones or messages. The process of establishing connection between device and a second communication device (or destination) is described in detail in FIGS. **31A**, **31B**, **31C**, **31D**, **32**, **33** and **34**.

In an embodiment of the invention, visual menu database **308** may include other information and parameters related to the visual IVR menus. The parameters related to the visual IVR menus enable accessing, modifying or updating of the visual IVR menus. Examples of parameters of visual IVR menus include, but are not limited to, ID or version of the

visual IVR menus, destination phone numbers, and a last update timestamp. Furthermore, visual menu database **308** may include other information such as a profile, the calling history, or preferences of the caller. The calling history of a caller may include the numbers dialed or received, most frequent numbers dialed or received, most frequent nodes selected from visual IVR menus. The profile of a caller may include, but is not limited to, the name, age, sex, address, phone number, profession, office address, recorded voice responses for visual IVR menus, or other personal and professional details of the caller.

FIG. **11** illustrates an exemplary process for presentation of the visual IVR menu when the call of caller **106** is forwarded or transferred from destination **108a** to destination **108b**, in accordance with an embodiment of the invention. Destination **108a** may have completely different audible IVR menus as compared to destination **108b**. For example, destination **108a** may be a loan department and destination **108b** may be an insurance department of a bank. Similarly, the call may be forwarded from one organization to another. For example, from one branch of a bank to another branch of same bank. Therefore, caller **106** may be required to respond to a different audible IVR menu. Visuphone **104** may be configured to detect that the call has been forwarded and subsequently display the visual IVR menu of destination **108b**.

As shown in FIG. **11**, device **102** establishes a connection with destination **108a** as depicted by arrow **1102**. The connection is established by using the visual IVR menu provided by Visuphone **104** based on destination **108a**. In an embodiment, the connection is established directly without using Visuphone **104**. Thereafter, destination **108a** may forward the call to destination **108b**, as indicated by arrow **1104**. The visual IVR menu corresponding to the audible IVR menu of destination **108b** may not be visible on device **102**, as the call was forwarded between destination **108a** and destination **108b**. In an embodiment, Visuphone **104** may not detect the forwarding of the call. In this case, device **102** may be presented with audible IVR menu of destination **108b**. Thereafter, Visuphone **104** may record the options and responses on device **104** for the audible IVR menu of destination **108b**. The recorded options and responses may be stored at remote repository **1004** for updating it. Further, the recorded options and responses may be stored visual IVR menu database of device **102**.

In an embodiment, destination **108b** sends an identity (ID) or version of the audible IVR menu to a caller as shown by arrow **1106**. The audible IVR menu ID is specific to the audible IVR menu of destination **108b**. Subsequently, display module **906** of Visuphone **104** uses the audible IVR menu ID to display the corresponding visual IVR menu. Further, a caller may select a node from the visual IVR menu corresponding to destination **108b**. Therefore, when a caller selects a node, a connection may be established with destination **108b**. In an embodiment of the invention, connection between device **102** and destination **108a** is disconnected after establishing a connection between device **102** and destination **108b**. In another embodiment of the invention, connection between device **102** and destination **108a** is maintained for complete communication session till the caller disconnects the call.

Another embodiment of the invention allow visual IVR menu for calls made from a conventional home telephone. FIG. **12** illustrate a phone **1204** connected to a Public Switched Telephone Network (PSTN) **1208** and through a gateway **1218** to the Internet network **1220**. Network **1220** may be any service provider that provides services, for example, but not limited to, telephone services, cell phone

services, wireless services, Internet services, cable television services, or various combinations of the above or other type of services.

Further, the connection to network **1220** is associated with a wide band Internet ‘smart’ modem **1206**. Phone **1204** may be a regular phone, such as a landline phone or a cordless landline phone. Modem **1206** may be a Digital Subscriber Link (DSL) modem or a cable modem that connects the home device to the Internet and/or computer network. Modem **1206** is connected to a service provider, and can provide the home devices with telephone, Internet and television services. Modem **1206** may provide both wired and wireless connections. As shown with reference to FIG. **12**, modem **1206** provides the home with the Internet through wire **1210** to a computer **1202**, or through a Wi-Fi connection. Modem **1206** comprises the ability to detect and recognize the dialing made by phone **1204**. The numbers dialed by phone **1204** to establish connection are then compared with a database, such as visual menu database **308**. Therefore, in case the dialed number corresponds to a destination with an audible IVR menu, and a corresponding visual IVR menu exists then, modem **1206** may provide the visual IVR menu on computer **1202** connected to it. Moreover, modem **1206** may use private web sites to present the visual IVR menu or just provide the dialed number to computer **1202**. Thereafter, a software tool on computer **1202** may present the visual IVR menu on the screen of computer **1202**.

Once the connection with the destination has been established, ‘smart’ modem **1206** will continue to monitor the numbers dialed or received by phone **1204** to browse or advance the visual IVR menu accordingly. Furthermore, the numbers dialed or received may be stored for future processing such as highlighting previous selections in the visual IVR menu, providing customized visual IVR menu, and so forth. The Visual IVR menu system comprising computer **1202** and Modem **1206** may incorporate additional enhancements as presented before such as automatic dialing of customer information. The automatic dialing may be achieved by using computer **1202** to initiate and execute such automatic dialing.

In another embodiment of the invention, a house television **1212** may be used to present the visual IVR menu. In various houses modem **1206** decodes television signals and transfer it to a set-top box **1216** that provide signals to television **1212**. The visual IVR menu may be presented on a channel dedicated for IVR. Therefore, when phone **1204** is used to initiate a call, modem **1206** can detect it and present the visual IVR menu corresponding to the dialed number on the designated channel of the television **1212**. Further, all the options described before can be provided now using the screen of television **1212** for the visual IVR menu. The caller selection can be done by using the simple home phone or alternatively using the TV **1212** set top box **1216** remote control. Further, television **1212** screen may be used to present the visual IVR menu in a few alternatives ways. For example, a device provided by a company named RokuInc., allows streaming of content from the Internet to television. Most set-top boxes now have an Internet connection or telephone connections. Furthermore, various devices such as some Digital Versatile Disc (DVD) players, and video game players or controllers such as Xbox or Playstation, can be connected to the Internet. Each of those devices may allow ‘smart’ modem **1206** to provide a visual IVR menu on the screens of television **1212**.

In another embodiment of the invention a telephone connection may be established through an external telephone service by using a computer, as discussed with reference to FIG. **13**. External telephone service provider **1310**, such as ‘Google Voice’, which a caller may use through the Internet

network from computer 1302. In such case, the caller can cause a telephone call to be established by indicating on service provider 1310—'Google Voice' web site a request to establish call to a designated location. Thereafter, the external service provider 1310 establishes connection 1306 by using PSTN 1308 to connect the caller telephone 1304 to a desired destination 1312. External service provider 1310 can now present the visual IVR menu as discussed above. External service provider 1310 may present the visual IVR menu on its web site and processed or advanced based on the dial choices made by the caller on his computer 1302. Furthermore, external service provider 1310 can also add various options as described before, such as but not limited to highlighting previous choices, automatic dialing of caller information and presenting related advertisements.

Another enhancement for such external service provider 1310 is to provide a 'smart' connect. In case of the 'smart' connect, the caller can designate not just destination 1312, but a specific node of visual IVR menu, such as node 212b as discussed with reference to FIG. 2B. The 'smart' connect will dial the proper selection in the visual IVR menu and connect to node 212b of the audible IVR. The 'smart' connect can even wait until the selected node 'Talk to Executive' yields the desired result of the executive answering the line and then connect the caller. Therefore, the efficiency of the IVR system does not come at the cost of inefficiency of the caller; rather both sides can become more efficient by using the 'smart' connect.

Additional alternatives to the invention are illustrated with reference to FIGS. 14A, 14B, and 14C. FIG. 14A illustrates a Visu-Add-on 1404 which can be connected to a standard home phone 1402 to provide all the features and functionalities as described above with respect to Visuphone 104. Accordingly, phone 1402 may be connected through connection 1406 to add-on 1404 that can be connected to a standard telephone connection line 1410. Add-on 1404 may comprise a processing unit, a display and a database. The database may be similar to visual menu database 308 as discussed in FIG. 3. Therefore, when phone 1402 is used to call a destination with an audible IVR menu, a corresponding visual IVR menu is presented on the display of add-on 1404. Furthermore, the display of add-on 1404 may comprise a touch sensitive screen for added convenience of a caller. Add-on 1404 may be loaded and updated by the use of removable memory devices, such as USB flash memory 1408. Alternatively, Add-on 1404 may comprise a modem to connect either by the use of the telephone connection line 1410 or by wireless means such as WiFi or Bluetooth.

FIG. 14B illustrates an embodiment, where an add-on unit 1414 is plugged into a conventional digital picture frame 1420 by using a USB port. Digital picture frames recently became quite popular as a convenient way to display family photos in digital format. In this embodiment, picture frame 1420 can display family photo until a call is made by using a phone 1412 to a destination with an audible IVR menu. Phone 1412 may be connected to picture frame 1420 through a connection 1418 and add-on 1414 may be further connected to standard telephone line connection 1422. Add-on 1414 may comprise a processor and a database. The database may be similar to visual menu database 308 as discussed in FIG. 3. Therefore, when a connection is made to a destination having an audible IVR menu, then add-on 1414 will present the visual IVR menu on picture frame 1420. Picture frame 1420 may resume presenting the photos after the completion of the call. Furthermore, the database of add-on 1414 could be updated with one of the options described before in respect to the add-on 1404 of FIG. 14A. It should be noted that various

home television provides functionality similar to picture frame 1420. Therefore, television can be used as an alternative to picture frame 1420.

FIG. 14C present another embodiment that can be applied as presented with respect to FIGS. 14A and 14B. It quite common these days to use a telephone handset 1424 that are connected by wireless means to a base station 1430 that is connected by a wire 1432 to the standard telephone lines. Add-on 1426 can comprise an internal radio circuit to detect the wireless communication. Therefore, add-on 1426 can detect the communication between handset 1424 and base station 1430 to present the visual IVR menu. As can be seen with reference to FIG. 14C, connection through wires such as wires 1406 or 1418 may not be required. Add-on 1426 may be provided by the manufacturer of the handset 1424 and the base station 1430, or by a third party. A person skilled in the art will appreciate that the functionalities of the add-on units as described in conjunction with FIGS. 14A, 14B and 14C can be combined into a single unit. Therefore, a single add-on unit may be used in various environments as discussed above.

FIGS. 15A, 15B, and 15C illustrate a flowchart diagram for presentation of the visual IVR menu, in accordance with an embodiment of the invention. Caller 106 may dial, select or receive a number to connect to a destination from device 102. The destination may include an audible IVR menu for interaction with a caller. Further, device 102 may include Visuphone 104 to present a visual IVR menu corresponding to the phone number of the destination. Therefore, a caller can directly interact with an IVR of destination through the visual IVR menu without listening to the audible IVR menu.

At step 1502, Visuphone such as of device 102 detects a phone number dialed, selected or received by caller for destination. In an embodiment of the invention, the number is clicked according to the display of device 102. The number is detected by detection module 902 of Visuphone 104. Thereafter, search module 904 searches visual menu database 308 of device 102 for the phone number, at step 1504. Search module 904 searches for visual IVR menu and other information corresponding to the phone number. Other information may include, for example, the caller profile, call history of the caller, advertisement associated with the phone number and so forth. In an embodiment of the invention, search module 904 searches visual menu database 308 in real-time. Therefore, the visual IVR menu and other information may be searched with only a few digits of the phone number.

At step 1506, it is determined by search module 904 whether the visual IVR menu and other information are available for the phone number in visual menu database 308. In case, the visual IVR menu is available, then the process continues to step 1508. In case, the visual IVR menu is not available, then device 102 may be connected to remote repository 1004 by update module 914, at step 1518 as shown with reference to FIG. 15B. Thereafter, it is checked whether the visual IVR menu is available in remote repository 1004, at step 1520. Subsequently, if the visual IVR menu is available, then visual menu database 308 is updated from the information available at remote repository 1004, at step 1522. The process then continues to step 1524.

Further, at step 1506, once it been determined by the search module 904 that the visual IVR menu for the destination is available in the visual menu database 308 an asynchrony request is sent to remote repository 1004, at step 1558. The request is sent to check whether a newer version of the menu with different content is available, at step 1560. Subsequently, if such version exists in remote repository 1004, then visual menu database 308 is updated accordingly, at step 1522. The process is then continues to step 1524.

In case, the visual IVR menu is not available in remote repository **1004**, then the process continues to step **1528**. At step **1528**, audible IVR menu selection is detected on device **102**. The audible IVR menu selection may be determined based on Dual Tone Multi Frequency (DTMF) tones or keys pressed by the caller of device **102**. Thereafter, in case a selection is detected, then the dialed number may be detected as a possible destination number. The dialed number may be provided to remote repository **1004** at step **1530**. Thereafter, the process continues to step **1526**, where remote repository **1004** is updated for information.

At step **1524**, it is determined by search module **904** if visual IVR menu is available for the dialed number in updated visual menu database **308**. In an embodiment, Visuphone detects the correctness of information based on the error received on connection to the IVR destination or behavior of the caller. In case, visual IVR menu is available, then the process continues to step **1508**. Otherwise, in case the visual IVR menu is not available, then the process continues to step **1526**, where remote repository **1004** is updated for information. In an embodiment, Visuphone **104** sends an error report to remote repository **1004** to initiate the update. The error report may include the error details of connection, behavior of the caller and other information required to update remote repository **1004**. In another embodiment, the caller may provide ratings for the correctness of the visual IVR menu and other information. Subsequently, the ratings are sent to remote repository **1004**. In an embodiment of the invention, ratings from multiple devices are received at remote repository **1004**. Thereafter, remote repository **1004** may be updated based on the ratings. In an embodiment of the invention, remote repository **1004** may be updated based on a pre-defined time interval. In another embodiment of the invention, remote repository **1004** is updated by an administrator of remote server **1102**.

At step **1508**, if the visual IVR menu is available in the visual IVR menu database, then the visual IVR menu corresponding to the audible IVR menu of destination is displayed on device **102**. In an embodiment of the invention, advertisements related to the type of destination are also displayed on device **102**. At step **1510**, inputs from the caller are detected on the visual IVR menu. In an embodiment, the inputs include the nodes of the visual IVR menu selected by the caller. In another embodiment, the inputs include the advertisement selected by the caller. Subsequently, device **102** is connected to destination based on the inputs provided by the caller, at step **1512**. At step **1514**, it is determined if the visual IVR menu displayed on device **102** is correct. In case, the visual IVR menu is not correct, then the process continues to step **1518**. Thereafter, the process steps as discussed above are followed. However, in case the visual IVR menu is correct, then the connection between device **102** and destination is maintained, at step **1516**. Moreover, further inputs from the caller are received, to continue the communication till the caller or destination disconnects the connection.

The information stored in remote repository **1004** may be gathered from various destinations. For example, various destinations may be called to detect audio IVR menus and accordingly generate the information for remote repository **1004**. With reference to FIG. **16** exemplary components of a device **1602** for implementing a database construction system **1606** are illustrated. Device **1602** can be a computing device such as, but not limited to, a server, a personal computer, a laptop, a mobile phone, a smart-phone, and so forth. Device **1602** can connect to network **1614** through a network interface **1612**. Further, device **1602** can connect to a PSTN **1618** through gateway **1616** and network **1614** through network

interface **1612**. Examples of network **1614** include, but are not limited to a LAN, WAN, the Internet and so forth. Although not shown, device **1602** can connect to various external devices such as hard disks, mouse, keyboard, speaker, microphone, displays, Universal Serial Bus (USB) devices and so forth. Further, device **1602** can connect to various destinations **1620a-n** through PSTN **1618**. Destinations **1620a-n** may provide audio IVR menu services. In an embodiment of the invention, device **1602** can connect to various devices that include Visuphone for providing updates to visual menu database **308**.

Device **1602** may include a memory **1604** that stores various programs, data and/or instructions that can be executed by a processor **1610**. Examples of memory include, but are not limited to, a Random Access Memory (RAM), a Read Only Memory (ROM), a hard disk, a computer-readable medium and so forth. A person skilled in the art will appreciate that other types of computer-readable media which can store data that is accessible by a computer, such as magnetic cassettes, flash memory cards, digital video disks, and the like, may also be used by device **1602**. Memory **1604** may include Database Construction System (DCS) **1606** for gathering audible IVR menu information, which could be called the IVR customization record, from the destinations and store it in a records database **1608**. In an embodiment of the invention DCS **1606** may be an application stored as software or firmware on device **1602**.

DCS **1606** may include various modules or instructions that may be executed by processor **1610** for generating information in records database **1608**, as explained in detail with reference to FIG. **17**. As discussed above, DCS **1606** may be implemented as software, or firmware on a device. DCS **1606** may be implemented as a standalone module or as several independent instances performing similar jobs without coupling to the IVR destinations. Further, the non-coupling may be managed by a centralize module that may allocate different IVR destinations to each implementation instance of DCS **1606**. In an embodiment of the invention, DCS **1606** and record database **1608** may be implemented on different devices.

Records database **1608**, may include multiple records. Further each record may include an IVR identity code, multiple internal destinations and an activation code for each said internal destination. The IVR identity code may be for example, the phone number of the destinations. The activation code may be for example, a telephone key that should be dialed such as a dial tone associated with the phone number. The internal destination is usually an extension to which the call will be forward once the caller makes a choice, according to the provided menu, and apply the activation code that is usually a dial tone transmitted to the IVR from the Visuphone once the caller dials or selects a proper number or option. Each internal destination may further include another internal destination or extension that may be referred to as a sub-internal destination. Moreover, each sub-internal destination may be associated with a sub-record.

Furthermore, the internal destinations may be associated with an icon code. As discussed above, the icons provide a convenient display for the caller of a visual IVR menu. In some audible IVR menus the activation code may be a voice command that could be activated by the caller by voicing his selection, or the Visuphone may transmit a pre-recorded voice command or a synthesized voice command when the caller makes a selection from the option menu of the visual IVR menu provided by the Visuphone. Further, records database **1608** may include a record of the metadata or keywords associated with the various options in the menus. The meta-

data and/or keywords may be used by the Visuphone to enable the caller to search for a desired menu by providing keywords. In an embodiment of the invention records database **1608** is remote repository **1004**.

FIG. **17A** illustrates exemplary components of DCS **1606**, in accordance with an embodiment of the invention. DCS **1606** may include a Database Construction Agent (DCA) **1720** for generating information in records database **1608**, as explained in detail with reference to FIG. **17B** and FIG. **17C**. Some destinations may provide downloadable records or information for the callers. Download module **1710** of DCS **1606**, downloads the information or records provided by the destinations. For example, download module **1710** may download recorded voice phrases, audio data of the audible IVR menu, activation codes, complete audible IVR menu file in a variety of formats and so forth. In an embodiment of the invention, DCS **1606** may connect to various devices that include Visuphone. Therefore, DCS **1606** may receive information from Visuphone, such as personal records, customized records of the callers, and frequently used numbers, keys and so forth. In an embodiment of the invention, download module **1710** may obtain permissions before downloading the information. The permission may be obtained from the caller, the destination or both. For example, download module **1710** may display a notification on screen on the device to the caller or administrator to permit or reject a download. Moreover, download module **1710** may send an authorized communication such as, but not limited to, a private key to the destination to authorize and obtain permission for download. Personalization module **1708** may generate personalized records for the callers by associating the personal information of the caller with the information, such as the telephone numbers stored in records database **1608**. The records can then be forwarded to the caller's device by download module **1710**.

Personalization module **1708** may be implemented as instructions executable by a processor. For example, the processor can be processor **1610** or a second processor dedicated for personalization module **1708**. Moreover, the second processor may be CPU **304**, CPU **504** or implemented in another device in communication with DCS **1606**.

DCA **1720** may include a Target List Module (TLM) **1722** that assigns the IVR destination or a target list to each instance of DCA **1720** for connecting and gathering information. The target list may include the IVR identity code, which can be as phone number or any type of information on how to connect to the IVR directly or indirectly. Further, the target list may include additional details such as internal destination. In an embodiment of the invention, the additional information of the internal destination may be implemented as one or more activation codes associate with the IVR identity code. DCA **1720** may include an IVR Tracking Module (ITM) **1724** that tracks IVR content from a root location associated with the Target information assigned by TLM **1722**. ITM **1724** constructs the full IVR content from a given IVR root.

ITM **1724** may include IVR Logic Module (ILM) **1726**. ILM **1726** may detect the type of IVR of the destination. Typically, various types of audible IVR menus are implemented by destinations. The audible IVR menus may be categorized into various types, such as a simple IVR, IVR with audio response, IVR with additional data authentication and so forth. ILM **1726** detects the type of audible IVR menu, and accordingly the information is generated for records database **1608**. Various categories of the audible IVR menu are explained in detail in conjunction with FIG. **19**. ITM **1724** may call the destinations to determine the category the audible IVR menu. Thereafter, ILM **1726** constructs the data-

base based on the category of the IVR. In an embodiment of the invention, ITM **1724** may call the destinations multiple times to determine the category of the invention. Various audible IVR menus may include a legal notice. For example, the audible IVR menu of a mortgage bank usually include an header stating that this is debt collector and anything stated during the call could be used for future collections. Other statements can be such as those that relate to the option to record the call and so forth. ILM **1726** may detect the legal statements and store them in records database **1608** in association with IVR identity code.

ILM **1726** as part of its internal algorithm will drive the interaction sessions with the IVR. ILM **1726** may include data structure optimized with the tracked IVR menus to decide a right path or a next choice at any existing stage of the IVR tracking. The decisions made by ILM **1726** may be optimized as a mathematically directed graph tracking process. The tracking process may use an option from the audible IVR menu that corresponds to a "return to a previous menu" option of the audible IVR menu. As a result, the number of sessions required for tracking the audible IVR menu is reduced.

The process of IVR tracking may require multiple communications with the audible IVR menu to completely determine the content. Further, during the tracking process the content of the audible IVR menu may be discovered partially. Therefore, ITM **1724** may include a Tree storage Module (TSM) **1728** to manage a temporary database record. Thereafter, when the process or a phase is complete, TSM **1728** may use Repository Connection Module (RCM) **1738** to submit the content as a batch of records to records database **1608**. In case, a connection to records database **1608** is not available, then TSM **1728** may accumulate the information until a connection can be established.

Dialog Module **1730** of ITM **1724** interacts with the audible IVR menu. Further, dialog module **1730** manages the IVR requests and sends responses according to the decisions of ILM **1726**. Further, dialog module **1730** may use a Speech recognition Module (SRM) **1732** to interpret the audio of the IVR request to generate multiple records for records database **1608**. In an embodiment of the invention, the audio is interpreted to generate text information. Moreover, SRM **1732** can provide a score to the text generated for each audio, according to the amount of guessing that is required for translating the IVR audio request. SRM **1732** may use a single grammar or a combination of dedicated grammars, for example, but limited to, a specific IVR service topic, IVR service sub topic, IVR stage, IVR location, the specific IVR, the hour of the day, and so forth. Furthermore, SRM **1732** may use multiple preset terms stored in the memory. Examples, of preset terms include, but not limited to, "yes", "no", name of the caller, and so forth. The text generated by SRM **1732** from speech recognition may be parsed by dialog module **1730** to enable ILM **1726** to select a next path or option.

Dialog module **1730** may be required to respond to the IVR requests during a tracking session. Dialog module **1730** may use a Response module **1734** to generate the required response. Various audible IVR menus require a voice response from the caller. For example, the voice response may be required for the authentication of the caller. Response module **1734** may provide a recorded voice response to the audible IVR menu. For example, the voice response may be recorded voice phrase or preset of terms such as, but not limited to, "yes", "no", name of the caller, and so forth. Further, the voice response may be a synthesized voice response, generated by response module **1734**. Therefore, response module **1734** may include a voice synthesizer. In

this case, the activation code may be the recorded voice phrase and/or the synthesized voice phrase. Moreover, response module **1734** may include a voice decoder to recognize the voice. For example, the voice prompts generated by an audible IVR menu. In some other cases, the IVR menus may require a simple key tone (DTMF). The response module **1734** may include recorded tones or an internal module to generate the require tones.

Various destinations may provide a different audible IVR menu in the working hours and a different menu after working hours or during the holidays. DCA **1720** may detect the various times or time periods for which the audible IVR menus are presented in different mode. SRM **1732** may decode the voice from the audible IVR menu to recognize the IVR message. Further, ILM **1726** may analyze the response message for the periods and different operating mode. Therefore, ILM **1726** may call the destinations based on the recognized periods to generate records database **1608**. Further, records database **1608** may include the time information for which a particular audible IVR menu is active. Accordingly, ITM **1724** may call the destinations multiple times based on the time information.

Various audible IVR menus include multi-level menus, as discussed with reference to FIG. 2A. Therefore, each level of menu may include sub-menus, which may further include sub-menus, and so forth. Accordingly, records database **1608** may include multiple sub-records, and each of the sub-records may have activation codes associated with them. Furthermore, records in records database **1608** may include a code to indicate a business domain of the destinations, such as airlines, banks and so forth. In an embodiment of the invention, TLM **1722** may use a web-based list such as yellow pages to call the destinations. Generally, the phone numbers of the destinations in the yellow pages are organized based on the business domains of the destinations. Accordingly the business domain code could be added to record database **1608**. As graphics and icons are very effective in enhancing caller interface, ITM **1724** may associate various phrases with specific icons. For example, ITM **1724** may include a dictionary of various terms or phrases that are frequently used in IVR menus, such as "customer care", "main menu", and so forth. The terms may be decoded by Dialog module **1730** and icons may be associated with them. Accordingly, records database **1608** may include a code for icons associated with the IVR menus of the destinations.

ITM **1724** may include components to connect to the audible IVR menu. As shown with reference to FIG. 17B, ITM **1724** may include a VOIP connection module **1736** to interact with a VOIP application **1740**. VOIP application **1740** may be implemented within or outside DCA **1720**. In such a case, VOIP connection module **1736** may use VOIP application **1740** to interact with the audible IVR menus.

Further, as shown with reference to FIG. 17C, ITM may include an IVR Connection module **1737**, to interact directly with the audible IVR menu. IVR connection module **1737** may connect to multiple audible IVR menus through a network, a PSTN or any other communication or protocol. Moreover, IVR Connection module **1737** may act as a gateway between DCA **1720** and the destination of audible IVR menu.

FIG. 18 illustrates a flowchart diagram for generating records database **1608** by using DCS **1606**, in accordance with an embodiment of the invention. The audible IVR menu of destinations may be analyzed to generate records database **1608** for corresponding visual IVR menus. At step **1802**, a phone number may be dialed to connect to an audible IVR menu of destination. The phone numbers and destinations may be selected automatically from a database of phone

numbers. For example, yellow pages for a selected territory, category, business or other suitable classifications. As discussed with reference to FIG. 2A, the audible IVR menu may include various options for a caller to select. Typically, the options are structured and presented in form of levels to the caller. For example, with reference to FIG. 2A, options **204a**, **206a**, and **220a** may form a first level of the audible IVR menu **222a**. Further, options **208a** and **210a** may be referred to as sub-menus to option **204a**. Similarly, each sub-menu may further comprise sub-menus, such as options **214a** and **216a**. Therefore, DCS **1606** is presented with audible instructions at first level. Thereafter, based on the selection by DCS **1606**, corresponding audible instructions of sub-menus may be provided. The first level of the audible IVR menu is analyzed at step **1804**. The audible IVR menu may be analyzed by voice recognition.

In an embodiment of the invention, the voice recognition for constructing records database **1608** is based on context-enhanced voice recognition. As the process of calling the destination is initiated by selecting a number from a list such as yellow pages, the voice recognition system would be provided file of potential menu terms, which could be farther narrowed base on knowledge of the business domain and the potential options such destinations may offer. Therefore, the process of voice recognition is greatly enhanced, when the recognition is done with respect to a relatively small number of choices. SRM **1732** in DCA **1720** may be pre-loaded with a small set of terms most likely used by the destination and, therefore, may be required to make the recognition out of the relatively small set of terms.

Further, the voice may be converted to a text format. In an embodiment of the invention, a voice-to-text application may be used to convert the audible instructions to text format. Subsequently, the information generated from the analysis of the first level is stored in records database **1608**, at step **1806**. The information may include the details about the sub-menu and the numbers to be dialed to access the sub-menu. For example, with reference to FIG. 2A, the information for option **204A** may include, instruction part 'pizza order' and number part '2' in the database. At step **1808**, it is determined whether there are any sub-menus in the audible IVR menu. The sub-menu may be detected based on the information analyzed from the audible IVR menu. In an embodiment of the invention, sub-menus are detected based on the information stored in the database.

In case the audible IVR menu contains sub-menus, then the sub-menus are analyzed, at step **1810**. The sub-menus may be analyzed in a similar manner as the first level of audible IVR menu as discussed above. Subsequently, at step **1812**, the information corresponding to the sub-menus is stored in records database **1608**. At step **1814**, it is determined whether there are any further sub-menus in the sub-menu of the audible IVR menu. DCS **1606** may make select an option for every menu to connect accordingly and determine if a final destination is reached or there is another layer of menu options to be processed. Once the final destination it reached, DCS **1606** may "hang-up" the connection and register the results. Further, DCS **1606** may dial again to iteratively discover the full menu of the IVR. In case, there are further sub-menus then each sub-menu is analyzed as discussed above. The process is iterated till the complete audible IVR menu with the sub-menus is analyzed. Further, the destinations may be dialed multiple times to ensure that complete audible IVR menu and sub-menus are analyzed.

Moreover, records database **1608** may be automatically checked and verified after complete analysis of the audible IVR menu. For example, all or various options or sub-menus

in the audible IVR menu may be selected randomly or based on a pre-defined pattern to verify the information in records database **1608**. In an embodiment of the invention, DCS **1606** may be use quality marks for every term recognized during the process. For example, low marks may indicate relatively higher probability that the recognition was wrong. Further, follow-up steps may provide higher priority to check and validate the terms that received low marks. Such check may be performed by an additional automatic system or by human operators. In an embodiment of the invention, the destinations may be connected automatically through various probe servers to analyze the audible IVR menus. The probe may be implemented as a script, a computer program, or firmware, on remote server **1002**, as shown with reference to FIG. **10**. Further, the audible IVR menus may be analyzed by human operators, in case of malfunction or other issues with the automatic functioning.

In an embodiment of the invention, records database **1608** may be updated automatically based on a pre-defined update time interval. The update may be required to validate the correctness of information in the database. Moreover, records database **1608** may be updated based on ratings from callers of Visuphone. For example, the caller may identify that a visual IVR menu incorrect or incomplete, and may subsequently provide a rating to the visual IVR menu. Further, an administrator or caller of records database **1608** may update it manually.

Various audible IVR menus require audio commands from the caller instead of selecting options. DCS **1606** analyzes such IVRs to generate records database **1608**. In an embodiment of the invention, a two-phase process may be applied to generate records database **1608**. In the first phase a standard menu is generated for the IVR that may relate to a particular class of the destinations. A class can be a business class, for example, banks, airlines, hospitals and so forth. The first phase could be extended to cover as many domains as possible so that standard menus exist for most business classes of destinations. In the second phase, the IVR that requires a natural language voice command may be interrogated by repetitively applying the standard menus according to the class. Therefore, the relevance of the standard menu for the specific IVR is confirmed. In the process, a stored voice or synthesized voice could be use for each menu option. Thereafter, the menu may be stored in records database **1608** based on the confirmation. Some IVR menus may require any or both of natural language commands and dial tones. In such a case, both options could be made available in the records database **1608**, and eventually in the visual IVR menu database for the caller at the time of use. As discussed with reference to FIG. **17**, DCS **1606** may determine the type of audible IVR menu for generating records database **1608**.

FIG. **19** illustrates an exemplary set of IVR categories **1902**. As shown a category A **1904** refers to typical audible IVR menus that present IVR options to the caller that can be selected from simple dial tone selections. In this case, DCS **1606** may provide various dial tones to the IVR for analyzing it, and generating records for records database **1608**. A category B **1906** refers to an audible IVR menu that requires the caller to answer some initial questions, before presenting simple dial tone options for further menu. For example, the caller may be required to select a language preference, before presenting the menu. A category C **1908** may require the caller to provide some personal information before presenting the menu. For example, the caller may be required to input an account number, a phone number, a customer number and so forth. A category C **1910** refers to an IVR menu that may require voice inputs or natural language selection from the

caller. In this case, DCS **1606** generates an activation code that points to a recorded voice phrase or a code that can instruct to synthesize the proper voice phrase required.

Additional variations of the categories include an IVR menu that provides a legal notice. For example, the audible IVR menu of a mortgage bank usually include an header stating that this is debt collector and anything stated during the call could be used for future collections. Other statements can be such as those that relate to the option to record the call and so forth. The statement may be registered and added to records database **1608**, so that the legal statement can be presented with the visual IVR menu. Further, additional statements may be added at the end of the statements regarding the last time when the IVR was verified.

FIG. **20A** illustrates an exemplary information process for an IVR menu stored in records database **1608**. Sometimes, an audible IVR may request the caller for some specific or personal information that is other than selection of IVR options. ILM **1726** may mark such requests and process them separately. ILM **1726** can identify such requests based on a combination of the identity code and an ordered list of activation codes. As shown, the records database content **2002** may include exemplary request **2004a** "Please enter the invoice number", request **2006a** "Please enter the payment amount", request **2008a** "Please choose your payment card: Press 1 for VISA and 2 for MasterCard", request **2010a** "Please say or enter credit card number", and request **2012a** "Please enter your Credit Card expiry date".

Corresponding to these requests a display may be generated on the caller's device, an exemplary illustration is as shown with reference to FIG. **20B**. As shown, a web form **2014** is generated corresponding to the requests. Web form **2014** may be presented on a web browser of the caller's device. In another embodiment of the invention, the display is presented as an independent form on the display of the device. Therefore, the device may not require a web browser application. Web form **2014** may include single or multiple pages. Further, in case the information is displayed directly on the device, then various screens, layers or scroll may be used to display the information. Web form **2014** may include an input box **2004b** corresponding to request **2004a**, input box **2006b** corresponding to request **2006a**, input box **2008b** corresponding to request **2008a**, input box **2010b** corresponding to request **2010a**, input box **2012b** corresponding to request **2012a**, and a submit button **2016**. The Visuphone on the caller's device may automatically complete some or even all the require details based on stored profile or previous inputs of the caller. Therefore, the caller may only (if at all) be required to complete the missing information manually. Subsequently, the Visuphone may connect to the IVR after the caller clicks on the submit button **2016**. Further, the Visuphone may navigate to the process root within the IVR menu, revalidate the process input requests, and transmit the caller data to the IVR without any action from the caller. Moreover, the Visuphone may hide the IVR validation question such as questions like "are you sure", "did you mean XYZ?" and so forth. After the submission, a response such as, but not limited to, a receipt number, specific flight landing time, and so forth may be presented to the caller. The response from the IVR can be in various forms, for example, but not limited to, a recorded audible response or a transcript of the audible response.

In another embodiment of the invention, electronic yellow pages directory allows the dialing the number directly from the directory and further provides the visual IVR menu of the destination. In an embodiment, one or more destinations along with their associated properties may be displayed at the device prior to displaying visual IVR menu. In an embodi-

ment, the one or more destinations are displayed based on the position of the dialed destination number and position of the one or more destinations. The caller can select the exact destination before dialing or follow the visual IVR menu after dialing. For example, an airline company might have various option, menus and layers in the large organization. Selecting the exact department in the organization before dialing can save the caller the time and overhead of listening to the menu and making decisions based on the voice menu. The yellow pages company can have a copy of the visual IVR menu database or can be connected to a visual IVR menu service in order to provide the menu to the caller.

In an embodiment, multiple options of destinations related to the dialed destination business category may be displayed by Visuphone **104** prior to displaying a visual IVR menu as described in detail in FIG. **21**. For example, when caller **106** dials a phone number of pizzeria then Visuphone **104** may first display all the pizzerias available in nearby area. Caller **106** may select one pizzeria from the list of pizzerias. Thereafter, Visuphone **104** may display a visual IVR menu associated with the selected pizzeria (or destination). Further, Visuphone **104** may display geographical information and properties corresponding to destination phone number dialed. In an embodiment, the geographical information may be displayed before a connection is established between device **102** and the dialed destination such as destination **108b**. Moreover, the visual IVR menu is displayed after caller **106** selects one or more destinations based on the information. In an embodiment of the invention, Visuphone **104** displays information for destinations **108a-n** based on a business category. For example, if the phone number dialed by caller **106** corresponds to a teleshopping network, then the information displayed may relate to the specific teleshopping network dialed and/or to other teleshopping networks. In another embodiment of the invention, Visuphone **104** displays the information based on a relative geographical distance of caller **106** from that of dialed destination. The distance may be within a predefined range. For example, the pre-defined range can be 0 to 5 km, 0 to 500 m, a caller defined value, and so forth.

FIG. **21** illustrates an exemplary display of representations **2102a-n** of destinations **108a-n** on device **102**, in accordance with an embodiment of the invention. In an embodiment, representations **2102a-n** may be displayed or presented to caller **106** prior to displaying visual IVR menu of a selected destination. Further, representations **2102a-n** may be displayed based on the distance or position of the destinations from the dialed destinations. In an embodiment, representations **2102a-n** may include information about various destinations which have same business category as of the dialed destination. For example, if caller **106** dials for a Chinese restaurant than Visuphone **104** will display representations of all restaurants serving Chinese food located within the predefined range of distance relative to caller **106**.

Further, representations **2102a-n** may include properties associated with destinations **108a-n**. Examples of the properties include, but are not limited to a location code, a branch code, rating, reviews, an address, phone numbers, distance from caller **106**, and so forth. In an embodiment of the invention, a caller representation as user **2104** corresponding to caller **106** may be displayed on device **102**. Examples of the representation **2102** include, but are not limited to, graphical or text representations such as a table of rows and columns, icons, area map, and so forth. Representations **2102a-n** may also include the distance of destinations **108a-n** with respect to the location of caller **106**.

Caller **106** may select a destination from the representations **2102a-n** based on one or more displayed properties.

Subsequently, the visual IVR menu of the selected destination may be presented to caller **106**. For example, if caller **106** selects destination **108c**, then a visual IVR menu corresponding to destination **108c** is displayed at device **102**. In an embodiment, the display may include representation of a subset of destinations **108a-n** based on one or more criteria. The one or more criteria include displaying destination based on business category of dialed destination phone number. In an embodiment, the one or more criteria may also include displaying destinations based on location of device **102** or caller **106**.

In an embodiment of the invention, device **102** may be an in-car navigation system such as a Global Positioning System (GPS). Therefore, when caller **106** dials a phone number of a destination, Visuphone **104** may provide a representation of one or more destinations on a map on device **102** screen. Further, the properties like location, reviews, ratings etc. associated with the destination may be displayed on the map. Caller **106** may interact with the displayed maps and can select a destination from the map based on the one or more properties. Further, caller **106** can select a destination by clicking or scrolling on the map. In an embodiment of the invention, a route map from caller **106** to the selected destination may be displayed on device **102** screen.

In an embodiment of the invention, device **102** can request for updates from a server through a communication network. The server may maintain the updated information of destinations and their associated properties. The communication network can include more than one device **102**. Examples of the communication network include, but are not limited to, the Network, PSTN, Local Area Network (LAN), Wide Area Network (WAN), and so forth.

Alternatively an enhanced web base yellow page could be provided, wherein the caller can first choose the provider he/she requires to contact. Thereafter, if that destination provides an IVR, then the enhanced yellow page will use the visual IVR menu database to present a visual IVR menu on the web page. Moreover, the caller can click to choose the internal destination of that provider and the enhanced yellow page may accordingly initiate the call. The call could be made using the conventional telephone network or PSTN. In this case, the enhanced yellow page may need the caller's telephone number to perform the connection. Alternatively, the enhanced yellow page could use VOIP to connect the caller over the web to the IVR of the destination.

In some IVR systems, the caller may have to wait or hold on a queue of previous dialers until the specific department or agent is available. In another embodiment of the invention, the enhanced yellow page system will connect the caller only after the specific agent is available, without waiting in a long waiting line queue. The system can recognize that the waiting queue message of the specific department, and to connect the caller only after the agent is answering. Therefore, the waiting time of the caller on the phone queue that sometimes may be very long, may be reduced. The system can park on the line for the waiting line on the specific entry in the menu; as soon as the agent is available the caller gets a signal to start the conversation with the agent.

FIG. **22** illustrates an exemplary visual IVR menu **2202** of the selected destination with added graphics for the nodes on device **102**. Visual IVR menu **2202** includes one or more options corresponding to every node in the destination. It is well known that graphics are easier to learn and are faster to recognize than words. Therefore, graphics can be used in various computerized device interfaces. Various types of graphics can be displayed for example, animated icons, icons that highlight or animate when the node is highlighted, and so

forth. The graphics may be displayed for each node or a few nodes based on the usability of visual IVR menu 2202. For example, for node 2210 an icon of a vegetable may be displayed to designate a vegetarian pizza, and for node 2216 of home delivery, an icon of house may be displayed. In an embodiment of the invention, visual IVR menu 2202 can be customized to display only the text, only the icons, or both. Furthermore, caller 106 can suggest or use various icons based on his preferences. The visual IVR menu is specific to a destination. Further, each of destinations 108a-n may have more than one audio IVR menus. So different visual IVR menu corresponding to one or more audio IVR menus is possible.

FIGS. 23A, 23B, and 23C illustrate a flowchart diagram for providing representation of destinations based on position, in accordance with an embodiment of the invention. Caller 106 may dial, select or receive one or more destination phone numbers to connect to a destination from device 102. Destinations 108a-n may include an audible IVR menu for interaction with a caller. Further, device 102 may include Visuphone 104 to display one or more representations corresponding to multiple destinations on screen or display of device 102. Further, the one or more representations may include properties associated with the multiple destinations. Visuphone 104 also presents visual IVR menu corresponding to the phone number of the selected destination. Therefore, a caller can directly interact with a visual IVR menu 2202 of selected destination through visual IVR menu 2202 without listening to the audible IVR menu.

At step 2302, Visuphone 104 identifies a phone number of a destination dialed by caller 106 of device 102. In an embodiment of the invention, the number is clicked according to the display of device 102. The number is identified by CPU 304. In an embodiment of the invention, Visuphone 104 displays at least one property associated with one or more destinations 108a-n based on the identified dialed phone number of the destination. Further, at step 2304, a location code associated with current location of device 102 is determined. The location code determines the present location of device 102. When caller 106 is in his/her home country or state, the location code of the device and location code of the dialed destination phone number is same. In an embodiment, when a person is on roaming the location code of caller 106 is different than the location code of the dialed destination phone number. This happens, in case when caller 106 is travelling and device 102 is on roaming. Central processing Unit (CPU) 304 of device 102 determines the location code of device 102.

At step 2306, CPU 404 determines a business category associated with the dialed destination phone number. Destinations 108a-n can be categorized into various groups based on their associated business category. Various destinations are grouped into a business category based on the services and operations of the destinations. At step 2308, CPU 304 searches visual menu database 308, for phone numbers of the destinations matching the business category of the dialed destination phone number. Further, at step 2310, CPU 304 checks whether the destination phone numbers matching the business category are available in visual menu database 308. In case the one or more destination phone numbers are available, then the process continues to step 2312, else the process control goes to step 2328.

At step 2312, CPU 304 searches for at least one phone number from the one or more destination phone numbers based on the location code. The location code is associated with device 102. The location code determines the present location of device 102. In an embodiment, CPU 304 searches

for at least one phone number from the one or more destination phone numbers based on the location code of device 102b and a location code of the dialed destination phone number. At step 2314, CPU 304 checks whether the at least one destination phone number matching the location code of the device is available in the visual menu database 308. In case the at least one destination phone number, then step 2326 is executed. At step 2326, a visual IVR menu of the dialed destination phone number is displayed on display 302, as shown with reference to FIG. 23C.

At step 2314, when the at least one destination phone number matching the location code of device 102 is not available in the visual menu database 308, the process continues to step 2316. At step 2316, the at least one destination phone number with its associated properties are displayed. CPU 304 displays the at least one destination phone number and associated properties on display 302 of device 102. Further, at step 2318, caller 106 selects a destination phone number from the displayed representations of destinations. At step 2320, a visual IVR menu of the selected destination is displayed on display 302 of device 102. CPU 304 displays the visual IVR menu on display 302.

As discussed with reference to FIG. 22, visual IVR menu 2202 includes one or more options. At step 2322, caller 106 selects an option from visual IVR menu 2202. Thereafter, at step 2324, device 102 connects to the selected option of the visual IVR menu 2202. Thereafter, caller 106 can interact according to his/her preference with the destination through the visual IVR menu 2202. At step 2310, when the one or more destination phone numbers matching the business category of the dial phone number, are not available in the visual menu database 308, the process continues to step 2328, device 102 requests for updates from a server of communication network. The updates include information associated with destinations 108a-n. The destination information includes destination phone number, and their associated properties. Further, at step 2330, the updates are received from the server by device 102. Then, at step 2332, the received updates are stored in the visual menu database 308 on device 102. Thereafter, the process continues to step 2308.

In another embodiment of the invention, electronic yellow pages directory allows the dialing the number directly from the directory and further provides representation of one or more destinations and the visual IVR menu of the destination. Therefore, the caller can first select a destination from the representation based on one or more properties such as reviews of that particular destination. The caller can select the exact destination before dialing or follow the visual IVR menu after dialing. For example, an airline company might have various option, menus and layers in the large organization. Selecting the exact department in the organization before dialing can save the caller the time and overhead of listening to the menu and making decisions based on the voice menu. The yellow pages company can have a copy of the visual menu database 308 or can be connected to a visual IVR menu service in order to provide the menu to the caller.

In an embodiment of the invention, Visuphone 104 may be configured to display one or more advertisements on device 102. As discussed with reference to FIG. 4 and FIG. 6 advertisement 408 may correspond to the type of services provided by the destinations dialed by a caller. For example, if destination dialed is a builder, then advertisement 408 may include promotions or offers about new plots or houses. Moreover, advertisement 408 may include promotions or offers from a third party or a competitor of the destination. Further, Visuphone 104 may be coupled to an advertising database. The advertising database may include advertisements related to

the phone numbers of the destinations. The advertising database may be stored at device **102**, the destinations, service providers or other third party servers. Further, the advertisements may be provided based on a profile of the caller. For example, assuming that the caller calls a bank holding his saving account. Therefore, the advertisement displayed to the caller may be based on the location, address, account balance, type and volume of transactions, loans, purchases, and so forth.

Visuphone **104** may be configured to connect to an intended destination, when the caller selects advertisement **408**. Further, Visuphone **104** displays visual IVR menu of the intended destination. In an embodiment, Visuphone **104** can store the interactions of the caller with visual IVR menus. For example, Visuphone **104** may automatically learn the numbers dialed or options selected from the menu. Moreover, the learned numbers or choices are associated with the dialed phone number of the destination. Therefore, the caller is assisted in his future calls. For example, when caller calls the destination again, then the actions that were performed in the last interaction are presented prominently to caller; or a previous sequence may be automatically performed. Further, the actions that are frequently performed are presented prominently to caller. For example, if caller dials a bank frequently to enquire about his account balance, then the options for selecting his account balance may be highlighted.

As discussed with reference to FIG. **9**, the advertisements are managed by advertisement module **912** of Visuphone **104**. The advertisement may be selected based on the type of destinations or a business domain of the destination. For example, when a dialed destination is a bank, then the dialed number is identified and an advertisement related to banking may be displayed. Moreover, the advertisement can be related to a third-party dealing in the same business or professional area or a competitor of the dialed destination. The displayed advertisement may be a text, audio, image or video. Moreover, the advertisement may include hyperlinks. For example, the hyperlinks may link to web pages of the called destination. In one embodiment, advertisement module **912** may display the advertisements based on the connection bandwidth available at device **102**. In another embodiment, advertisement module **912** may display the advertisements based on the pre-set preferences by caller **106**. In one embodiment, advertisement module **912** may be configured to receive the advertisements directly from the dialed destination.

In another embodiment, advertisement module **912** may be configured to receive the advertisements from a remote server on a communication network. The remote server is explained in detail in conjunction with FIG. **10**. A selection of options or click by caller **106** on advertisements may be detected by detection module **902** to display a visual IVR menu of the destination for which the advertisement was displayed. Furthermore, the advertisements may be associated with the personal data of caller **106**. For example, the advertisement may be displayed based on the calling pattern of caller **106**.

FIG. **24** illustrates a flowchart for presenting advertisements along with the visual IVR menu on the device, in accordance with an embodiment of the invention. In an embodiment of the invention, Visuphone **104** may display advertisements along with the visual IVR menus on device **102**. Device **102** can be a communication device or a device capable of data and/or voice communication. The advertisements may be stored in a database. In an embodiment, visual menu database **308** of device **102** may store the advertisements. In an embodiment of the invention, the advertisements may be stored on a remote database that can be connected to device **102**.

At step **2402**, a number dialed by a caller such as caller **106** for a destination is identified by Visuphone **104**. The destination may be associated with an IVR, for which a visual IVR menu is displayed on device **102**. Moreover, the telephone numbers or the destinations or the IVR systems may be categorized based on a business domain. At step **2404**, advertisement associated with the dialed phone number is searched in the database. In an embodiment of the invention, the advertisements are searched based on the business domain of the dialed number. For example, when a dialed destination is a bank, then the dialed number is identified and an advertisement related to banking such as investment schemes may be displayed. Moreover, the advertisement can be related to a third-party dealing in the same business or professional area or a competitor of the dialed destination.

Thereafter, at step **2406** the advertisement searched is displayed on device **102**. In an embodiment of the invention, multiple advertisements can be displayed on device **102**. The displayed advertisement may include text, graphics, audio, image, video or hyperlinks. For example, the hyperlinks may link to web pages of the called destination. In one embodiment, advertisement module **912** may display the advertisements based on the connection bandwidth available at device **102**. Further, the advertisements may be displayed based on the pre-set preferences by caller **106**. In one embodiment, the advertisements may be downloaded from dialed destination or remote database on a server in the network.

Further, caller **106** may interact with the displayed advertisements. For example, caller **106** may click the advertisement, or select an option from the advertisement. The options may be telephone numbers, destinations or an internal department of the destination. At step **2408**, it is determined whether caller **106** has selected the advertisement. Subsequently, in case caller **106** has not selected the advertisement then the existing advertisement is displayed as discussed at step **2406**. In an embodiment of the invention, the advertisement is displayed for a pre-set time duration. Otherwise, in case the advertisement is selected by caller **106** then the process continues to step **2404**, where the telephone number of the destination associated with the advertisement is used to search for advertisement.

In an embodiment of the invention, Visuphone **104** may be configured to submit personal information of a caller prior to establishing a connection with a dialed destination. In an exemplary scenario, the personal information may be used for authenticating the caller at a service login (such as for a web site or for a bank).

FIG. **25A** illustrates an exemplary information process for an IVR menu stored in records database **1608**, in accordance with an embodiment of the invention. Sometimes, an audible IVR or visual IVR menu may request the caller for some specific or personal information that is other than selection of IVR options. In an embodiment, the specific information may be requested in form of one or more fields, in which the caller can enter the information. For example, for a bank IVR system, when a caller selects an option from the displayed visual IVR menu of the bank, the caller may be presented with a form asking for one or more fields such as callname, password, and so forth. In an embodiment, IVR logic module (ILM) **1726** as shown in FIG. **17** may mark such requests and process them separately. Further, ILM **1726** can identify such requests based on a combination of the identity code and an ordered list of activation codes.

In another embodiment, caller **106** may be required to provide the specific or personal information as audio or voice inputs. Some organizations such as banks may require caller **106** to present one or more information in form of voice input

45

for the purpose of authentication. For example, caller **106** may be required to voice out his name or an answer to a security question specified by caller **106** to the bank. Furthermore, the voice input may be required to accept or decline a transaction. Further, caller **106** may record and store the voice responses for such authentications or questions alternatively the system can use synthesis voice. As discussed with reference to FIG. **16** the audio prompts or voice inputs may be stored in the records database **1608** as content **2502**. For example, the audio prompts may be converted to text and stored as content **2502**. As shown, content **2502** of records database **1608** may include an exemplary request **2504a** "Please enter the login identity (ID)", a request **2506a** "Please enter the password".

As also discussed above, Visuphone **104** maintains a profile of the caller. Moreover, the caller can edit, remove, and/or update the profiles. For example, the profile may include information such as name, address, account type and codes, passwords, and so forth. Therefore, Visuphone **104** may match the content **2502** with the profile of the caller. As discussed with reference to FIG. **9**, voice module **910** may be used when connection module **908** detects that a voice authentication is required. Voice module **910** is configured to provide voice inputs on behalf of the caller by using the responses recorded by the caller. Subsequently, the connection or the transaction can be processed.

FIG. **25B** illustrates an exemplary web form generated for the information process of FIG. **25A**, in accordance with an embodiment of the invention. As shown, web form **2510** may be generated corresponding to the requests. Web form **2510** may be presented on a web browser of the caller's device such as device **102**. In another embodiment of the invention, the display is presented as an independent form on the display screen of the device of the caller. In an embodiment, web form **2510** may include single or multiple pages. Further, in case the information is displayed directly on the device, then various screens, layers or scroll may be used to display the information. Web form **2510** may include an input box **2504b** corresponding to a request **2504a**, an input box **2506b** corresponding to request **2506a**, and a submit button **2508**. In an embodiment, Visuphone **104** on the caller's device may automatically complete some or even all the require details based on stored profile or previous inputs of the caller. Therefore, the caller may only (if at all) be required to complete the missing information manually. Subsequently, Visuphone **104** may connect to the IVR after the caller clicks on the submit button **2508**.

Further, Visuphone **104** may navigate to the process root within the IVR menu, revalidate the process input requests, and transmit the caller data to the IVR (or destination) without any action from the caller. Moreover, Visuphone **104** may hide the IVR validation question such as questions like "are you sure", "did you mean XXXX?" and so forth. After the submission, a response such as, but not limited to, a receipt number, saving account statement, and so forth may be presented to the caller. The response from the IVR system can be in various formats, for example, but not limited to, a recorded audible response or a transcript of the audible response. In an embodiment, Visuphone **104** may convert the format of the received response from a first format to a second format. In an embodiment, Visuphone **104** may change the format of the response from an audio format to a text format.

FIG. **26** illustrates a flowchart for submitting personal information of a caller by Visuphone **104**, in accordance with an embodiment of the invention. At step **2602**, caller **106** dials a phone number of a destination **108** such as destination **108a**. Subsequently, at step **2604** a visual IVR menu associated with

46

the dialed number is displayed on the display screen of caller device **102**. For example, destination **108** may be a bank. Thereafter, at step **2606** caller **106** may select an option from the displayed visual IVR menu. For example, caller **106** may select to make a transaction from account, so caller **106** may select an appropriate option from the displayed visual IVR menu. In an embodiment, caller device **102** can be a communication device such as a mobile phone, a laptop computer, and so forth. Typically, banking services may require caller **106** to provide authentication information before a transaction can be made. At step **2608**, a form indicating the information required by the IVR of dialed destination **108** may be displayed on the display screen of caller device **102**. In an embodiment, the form may include one or more data request fields. Further, the form is displayed corresponding to the visual IVR menu associated with the dialed destination. The exemplary form is discussed in conjunction with FIG. **25B**.

Subsequently, at step **2610**, Visuphone **104** may fill the information in the form displayed. In an embodiment, Visuphone **104** may fill the form partially. In an embodiment, the one or more data request fields may be filled based on predefined information. The predefined information may be associated and/or specific to the visual IVR menu of the dialed destination. In an embodiment, the predefined information may be defined by caller **106**. In an embodiment of the invention, Visuphone **104** may require caller **106** to provide at least one count of authentication information from the perspective of security. In an embodiment, caller **106** may fill the one or more data request fields with important information. Further, caller **106** may define the predefined information. Caller **106** can also be referred as a caller. For example, Visuphone **104** may submit the name and account number of caller **106**, but may not submit the transaction password. In another embodiment of the invention, Visuphone **104** may allow caller **106** to submit, edit and/or update the complete information in the form. Therefore, the updated information may be stored in the database on caller device **102**. Thereafter, at step **2612** the connection between dialed destination **108** and caller device **102** may be established and the information stored in the form is submitted. Typically, the IVR of destination **108** may require caller **106** to provide the information in form of audio inputs. Therefore, Visuphone **104** may provide audio inputs corresponding to the information of the form. In an embodiment of the invention, the audio format of the information may be stored in caller device **102**. In another embodiment of the invention, Visuphone **104** may convert the stored text data to audio information and submit it to the IVR of destination **108**. Thereafter, caller **106** may interact with dialed destination **108**.

In an embodiment, caller device **102** may receive a response from the dialed destination. In an embodiment, Visuphone **104** may convert a format of the received response from a first format to a second format. For example, Visuphone **104** may convert the receiver format of the response from the audio to text. In an embodiment, the first format of the received response may be an audio format. Examples of the audio format include, but are not limited to, WAV, Real Audio, Musical Instrument Digital Interface (MIDI), Windows Media Audio (WMA), MP3, Ogg, and so forth. In an embodiment, the second format may be a text format such as a Unicode text, Rich Text format, Hyper Text Markup Language (HTML) or any other format compatible with the caller device **102**.

In an embodiment of the invention, Visuphone **104** may call the dialed destination based on predefined calling information automatically; it is described in detail in FIGS. **30A** and **30B**. In an embodiment, Visuphone **104** may keep on

calling to the dialed destination until the requested information is received. Further, Visuphone **104** may save and/or display the received information at device **102**.

FIG. **27** illustrates an exemplary representation of a visual IVR menu **2702** associated with the dialed phone number of the destination along with a scheduling mode option, in accordance with an embodiment of the invention. Visual IVR menu **2702** includes one or more options corresponding to every node in the audible IVR menu of the dialed destination of destinations **108a-n**. Visual IVR menu **2702** is an exemplary visual IVR menu of a pizzeria. It is well known that graphics are easier to learn and are faster to recognize than words. Therefore, graphics are used in various computerized device interfaces. Various types of graphics can be displayed for example, animated icons, icons that highlight or animate when the node is highlighted, and so forth. The graphics may be displayed for each node or a few nodes based on the usability of visual IVR menu **2702**. For example, for node **2710** an icon of a vegetable may be displayed to designate a vegetarian pizza, and for node **2716** of home delivery, an icon of house may be displayed. In an embodiment of the invention, the visual IVR menu **2702** can be customized to display only the text, only the icons or both. Furthermore, caller **106** can suggest or use various icons based on his preferences. The visual IVR menu is specific to a destination.

Further, each of destinations **108a-n** may have more than one audio IVR menus. Therefore, different visual IVR menus corresponding to one or more audio IVR menus can be available for each of destinations **108a-n**. In an embodiment, device **102** may include more than one visual IVR menus for each destination of destinations **108a-n** based on the time. Therefore, different visual IVR menus corresponding to a destination **108** might be presented to caller **106** depending on the time of dialing to destination **108**.

In an embodiment of the invention, a scheduling mode option **2720** can be displayed on the screen along with the visual IVR menu associated with the dialed destination. Caller **106** may switch device **102** to a scheduling mode by selecting scheduling mode option **2720**. When device **102** is in scheduling mode, Visuphone **104** may start saving the inputs of caller **106**. The inputs from caller **106** may include the selection of one or more options of the displayed visual IVR menu **2702**. In the scheduling mode, Visuphone **104** may display one or more input options on the screen to enter a call schedule by caller **106**. The call schedule may include information such as a date and a time. The selection of the date and the time is explained in conjunction with FIG. **28**.

Furthermore, Visuphone **104** may automatically call a phone number of a destination of destinations **108a-n** automatically based on predefined calling information. The predefined calling information can be entered and/or selected by caller **106**. The predefined calling information may include the selection information such as one or more options of visual IVR menu **2702** that are selected by caller **106** in the scheduling mode. Further, the predefined calling information may include the call schedule, which is the date and time information for the call. In an embodiment of the invention, the predefined calling information may also include additional data such as a predefined time interval, maximum number of dialing attempts, waiting time, and so forth.

In another embodiment of the invention, device **102** may be switched to the scheduling mode based on a predefined key sequence. Caller **106** may press or select or enter a predefined key sequence for switching device **102** to a scheduling mode. The predefined key sequence may be a combination of one or more keys. For example, the predefined key sequence may include two asterisks (*) after dialing a phone number such as

123-456-7890**. Visuphone **104** may detect such predefined key sequence dialed and switch device **102** to the scheduling mode. Thereafter, Visuphone **104** may save the user inputs. Further, Visuphone **104** may display the visual IVR menu associated with the dialed destination. Furthermore, Visuphone **104** may allow caller **106** to schedule the call by entering date and time information.

FIG. **28** illustrates another exemplary representation of a visual IVR menu **2802** associated with the dialed phone number of the destination along with the scheduling mode option **2720**, in accordance with an embodiment of the invention. Visual IVR menu **2802** is an exemplary visual IVR menu of a bank. Visual IVR menu **2802** includes one or more options corresponding to every node in the audible IVR menu of the bank (or dialed destination of destinations **108a-n**). Though not shown, nodes of visual IVR menu **2802** may be represented using graphics such as, animated icons, icons that highlight or animate when the node is highlighted, and so forth. Further, graphics may be displayed for each node or a few nodes based on the usability of visual IVR menu **2802**. Visual IVR menu **2802** includes nodes such as personal banking node **2806**, NRI banking node. Caller **106** can choose NRI banking by pressing a combination 1-3. Thereafter, caller **106** can select investment option by pressing 2. Furthermore, caller **106** can suggest or use various icons based on his preferences. The visual IVR menu is specific to a destination. For example, hospitals will have different IVR menu than that of the bank. In an embodiment, scheduling mode option **2720** may also be displayed on the screen of device **102**. Caller **106** can select scheduling mode option **2720** for switching device **102** to the scheduling mode. Further, Visuphone **104** may start saving one or more inputs from the caller after switching to the scheduling mode.

FIG. **29** illustrates an exemplary display at device **102** after switching to a scheduling mode, in accordance with an embodiment of the invention. As discussed with reference to FIG. **27**, Visuphone **104** may save the inputs from caller **106** after switching to the scheduling mode. Device **102** switches to the scheduling mode based on the selection of the scheduling mode option **2720** by caller **106**. In an embodiment, Visuphone **104** may be configured to detect the selection of the scheduling mode option **2720** by caller **106**. In an embodiment of the invention, caller **106** may enter and/or select a call schedule **2902**. For example, call schedule **2902** may include, but are not limited to, a date and time information. A calendar **2904** may be displayed on the screen of device **102** for entering and/or selecting the date information for scheduling the call. A time input box **2906** may be displayed on the screen of device **102a** for entering and/or selecting the time information for scheduling the call. For example, the call schedule information will include a date Mar. 15, 2011, and time 11:25:40, therefore Visuphone **104** dial at the phone number of the destination on Mar. 15, 2011 at 11:25:40 AM. In an embodiment, the time information may be displayed in 12 hour format. In another embodiment, the time information may be displayed in 24 hours format.

In another embodiment of the invention, call schedule **2902** may include a predefined schedule for calling to the destination. For example, Visuphone **104** may automatically schedule a call in next five minutes on the same day, based on the predefined schedule. In an embodiment, caller **106** is not required to enter or select the date and the time information for scheduling the call. In such a case, Visuphone **104** automatically schedules the call to the destination based on the predefined schedule. A person skilled in the art will appreciate that the date and time for predefined schedule is not limited to five minutes or same day, and can be edited by

caller **106**. Further, call schedule **2902** may also include additional information such as maximum number of calling attempts, waiting time, and so forth.

Thereafter, a communication is established between device **102** and the dialed destination. After establishment of the communication, Visuphone **104** may request and/or receive information from the dialed destination based on the selection information of the predefined calling information. In an embodiment, Visuphone **104** may keep on dialing the phone number of the destination until the requested information is received from the dialed destination based on the selection information. In an exemplary scenario, Visuphone **104** may be required to dial the phone number of the destination repeatedly when the requested information is not available on the dialed destination. The call schedule may further include the predefined time interval for calling the destination. For example, when the communication is not established with the dialed destination, Visuphone **104** can call the destination after waiting for the predefined time interval such as after ten minutes. A person skilled in the art will appreciate, that the predefined time interval is not limited to ten minutes, and can be edited by caller **106**. In an exemplary scenario, if the requested information is not available at the dialed destination, than Visuphone **104** may wait for the predefined time interval of the call schedule and may call the previously dialed destination again, and may request for the desired information according to the selection information.

As discussed with reference to FIG. 3A, visual menu database **308** may store the predefined calling information. Further, visual menu database **308** may store the selection information and call schedule **2902**. In an embodiment, call schedule **2902** may also include a predefined time interval and a predefined schedule. In an embodiment, visual menu database **308** may further store the predefined schedule and predefined time interval. Device **102** may also request or receive updates from the server at a predefined time. The predefined time may be for example, once a week, once a month, or any other interval predefined by caller **106** or Visuphone **104**.

FIGS. 30A and 30B illustrate a flowchart for providing enhanced telephony by presenting a scheduling mode option **2720** to caller **106**, in accordance with an embodiment of the invention. Caller **106** may dial, select or receive one or more destination phone numbers to connect to a destination from device **102**. Destinations **108a-n** may include an audible IVR menu for interaction with caller **106**. Further, device **102** may include Visuphone **104** to display a visual IVR menu associated with a phone number of a destination dialed by caller **106**. As discussed with reference to FIG. 27, Visuphone **104** may further display scheduling mode option **2720** at device **102**. Visuphone **104** may establish a communication with the phone number of the destination based on the predefined calling information. In an exemplary scenario, a user of device calls a bank, than a scheduling mode option and a visual IVR of the bank may be displayed on the device. Sometimes, the user might not be able to receive desired information during this call then the user can switch to a scheduling mode by selecting the scheduling mode option. Thereafter, Visuphone **104** may ask the user to enter predefined calling information. Later, Visuphone **104** may dial the phone number of the previously dialed bank based on the predefined calling information.

At step **3002**, a phone number of a destination is dialed from device **102**. Caller **106** may dial the phone number of destination of destinations **108a-n**. At step **3004**, a visual IVR menu associated with the dialed number and a scheduling mode option **2720** is displayed at device **102**. As discussed

with reference to FIG. 3A, visual IVR menu **2702** and scheduling mode option **2720** may be displayed on display **302** of device **102**. In an embodiment, caller **106** may interact with the dialed destination and request for information, by selecting one or more options of the visual IVR menu. In an embodiment, the requested information may not be available at the dialed destination at the time of the call. Therefore, in such a case caller **106** may need to dial the destination again or caller **106** may schedule a call at later time. At step **3006**, device **102** is switched to a scheduling mode. Caller **106** selects scheduling mode option **2720** for switching device **102** to the scheduling mode. As discussed with reference to FIGS. 1A and 27, in scheduling mode Visuphone **104** may save inputs such as predefined calling information from caller **106**. The predefined calling information may include selection information and a call schedule.

At step **3008**, Visuphone **104** saves the selection information including the one or more options of the displayed visual IVR menu. The one or more options are selected by caller **106**. Thereafter, a display **2700** of device **102** switches to display **2900** including calendar **2904** and time input box **2906**. Caller **106** may enter the date and time information in calendar **2904** and time input box **2906** respectively. At step **3010**, Visuphone **104** saves the call schedule including the date and time information.

At step **3012**, it is checked whether the entered call schedule's date and time has arrived. Visuphone **104** may perform the checking by comparing the call schedule's date and time with the current date and time. In an embodiment, Visuphone **104** determines the current date and time based on the system clock and/or internet. If the call schedule's date and time is not equal to current date and time, then at step **3014** the process waits for the call schedule's date and time to arrive, otherwise the process control goes to step **3016**. At step **3016**, Visuphone **104** dials the phone number of the destination. Visuphone **104** dials the phone number of the destination based on the call schedule of the predefined calling information and without any user intervention. Thereafter, Visuphone **104** may establish a connection with the dialed destination.

At step **3018**, Visuphone **104** requests information from the dialed destination based on the selection information of the predefined calling information. In an embodiment, the requested information may not be available at the dialed destination at this time, so Visuphone **104** may wait for the predefined interval and may dial the phone number of the destination again. Examples of the predefined time interval may include, but are not limited to, thirty seconds, one minute, five minutes, ten minutes, twenty minutes, and so forth. In another embodiment, the dialed destination may transfer the request for the information by Visuphone **104** to the server, when the information is not available at the dialed destination. In another embodiment, when the information is not available at the dialed destination, the request of the information may be transferred to another destination of destinations **108a-n**. In an embodiment, caller **106** may interact with the dialed destination after establishment of the communication by Visuphone **104**.

At step **3020**, the requested information is received at device **102**. The dialed destination may send the requested information to device **102** based on the availability of the information. In an embodiment, the requested information may be received from the another destination of destinations **108a-n**. In yet another embodiment, Visuphone **104** may receive requested information from the server. In an embodiment, Visuphone **104** may convert the format of the received information from a first format to a second format. In an embodiment, the first format of the received information may

be an audio format. Examples of the audio format include, but are not limited to, WAV, Real Audio, Musical Instrument Digital Interface (MIDI), Windows Media Audio (WMA), MP3, Ogg, and so forth. In an embodiment, the second format may be a text format such as a Unicode text, Rich Text format, HyperText Markup Language (HTML) or any other format compatible with device **102**.

At step **3022**, Visuphone **104** saves the received information at device **102**. In an embodiment, the saved information may be accessed by caller **106** in real time. In another embodiment, the saved information may be accessed by caller **106** later. At step **3024**, Visuphone **104** displays the received information on display **302** of device **102**.

According to an embodiment of the invention, Visuphone **104** may send one or more data packets (or messages) for establishing a connection or communication session in a communication network **3100** as illustrated in FIGS. **31A-D**. FIGS. **31A-D** illustrates exemplary environments, where various embodiments of the invention can function. Communication network **3100** includes a device **3102a**. In an embodiment, communication network **3100** may include different types of devices **3102a-n**. Herein after, device **3102a** may be referred as a first communication device. A person skilled in art will appreciate, that communication network **3100** may also include a plurality of devices **3102**. Examples of communication network **3100** include, but are not limited to, the Internet, PSTN, Local Area Network (LAN), Wide Area Network (WAN), Metropolitan Area Network (MAN), and so forth. In an embodiment, communication network **3100** can be a data network such as the Internet. The data network is a network capable of establishing data and voice communication among various communication devices. In an embodiment, communication network **3100** can be a telecommunication or telephone network capable of establishing only voice communication among various communication devices.

Further, communication network **3100** includes a second communication device **3108a**. In an embodiment, communication network **3100** may include a plurality of second communication devices **3108**. A caller **3106** may use first communication device **3102a** to connect to second communication device **3108a**. First communication device **3102a** can be a telecommunication device that can connect directly to a PSTN **3110**. A person skilled in the art will appreciate, that first communication device **3102a** can also connect to a private telephone exchange. Examples of first communication device **3102a** include, but are not limited to, a telephone, a mobile phone, a smart phone or any other device capable of voice or data communication. Caller **3106** may dial a phone number associated with second communication device **3108a** for connecting to second communication device **3108a**. First communication device **3102a** may have one or more associated phone numbers, which may be used by other devices for connecting to first communication device **3102a**. Similarly, each of the plurality of second communication device **3108** may have associated at least one phone number. In another embodiment, first communication device **3102a** may include a plurality of visual IVR menus corresponding to phone numbers of the plurality of second communication devices **3108**.

In an embodiment, first communication device **3102a** may include an IVR application. In an embodiment, first communication device **3102a** may include the IVR application such as Visuphone **3104a** as shown in FIG. **31A**. Visuphone **104a** may provide data regarding a phone number of second communication device **3108a** dialed by caller **3106**. For example, the data may include geographical information or services

provided by second communication device **3108a-n**. Second communication device **3108a** includes an IVR system. The IVR system allows caller **3106** to interact automatically with second communication device **3108a**. When caller **3106** dials a phone number and connects to second communication device **3108a**, an audible IVR menu may be played to caller **3106**. Second communication device **3102a** can have more than one IVR menus. Visuphone **3104a** may display a visual IVR menu on first communication device **3102a** corresponding to the audible IVR menu associated with the phone number of second communication device **3108a** to be connected.

Second communication device **3108a** can be a device capable of data/voice communication. Examples of second communication device **3108a** include, but are not limited to, a telephone, a computer, a laptop computer, a personal digital assistant (PDA), a mobile phone, and so forth. Various types of second communication device **3108a** that implement the audible IVR menu include, for example, banks, hotels, fast-food outlets, utility services providers, corporate offices, mobile phone service providers, hospitals, and so forth. Further, second communication device **3108a** can have more than one audio/visual IVR menus. Typically, the audible IVR menu provided by second communication device **3108a** comprises audible options or instructions. In an embodiment, the visual IVR menu includes one or more text and/or graphical representation of different nodes corresponding to different nodes of the audio IVR menu.

In an embodiment, Visuphone **3104a** may send or receive one or more messages to or from second communication device **3108a** for establishing a communication session in communication network **3100**. The one or messages may be sent as data packets when a data network such as the Internet is available. In an embodiment, the one or more messages may be sent as DTMF signals or tones. After establishing a communication session with second communication device **3108a**, caller **3106** can interact with second communication device **3108a** via the visual IVR menu associated with second communication device **3108a**.

In an embodiment, first communication device **3102a** may receive an acknowledgement message from second communication device **3108a**. In an embodiment, the acknowledgement message is received only when second communication device **3108** includes an IVR application such as Visuphone. The Visuphone will have similar functionality as explained in above figures.

In an embodiment, second communication device **3108** such as a second communication device **3108b** may include an IVR application such as Visuphone **3104b** as shown in FIG. **31B**. As shown communication network **100** may further include a second communication device **3108b** (herein after second communication device **3108** may be used to refer second communication device **3108b** and second communication device **3108a** collectively or interchangeably). Visuphone **3104b** may send or receive one or more messages including information such as acknowledgment to or from first communication device **3102a**. Visuphone **3104b** is capable of sending messages required to establish a communication session with first communication device **3102a**.

FIG. **31C** illustrates another exemplary environment where communication device may exchange one or more messages or data packets for establishing communication session, in accordance with an embodiment of the invention. As shown, first communication device **3102b** can be a communication device that may be connected directly to a network **3112**. Examples of first communication device **3102b** include, but are not limited to, a personal computer, a laptop, a mobile phone, a smart-phone, a fixed line telephone, a Voice Over

Internet Protocol (VOIP) phone or other devices capable of voice or data communication. Examples of network **3112** include any wired or wireless network, such as but not limited to, LAN, WAN, a Wi-Fi network, and so forth. Further, first communication device **3102b** may include various applications or computer programs that enable caller **3106** to use first communication device **3102b** for dialing a phone number of second communication device **3108a-n** through PSTN **3110** over network **3112** through a gateway **3114**. For example, the applications may be VOIP applications, such as but not limited to, Skype, Magic Jack, Google Talk, and so forth. As discussed with reference to FIG. **31A** and FIG. **31B**, second communication device **3108b** (or **3108a**) presents the audible IVR to first communication device **3102b**.

Further, Visuphone **3104a** may search or detect a data network. In an embodiment, Visuphone **3104a** may send one or more messages in the form of data packets to second communication device **3108b**, when a data network such as the Internet is detected or available. Further, Visuphone **3104a** may establish a communication session with second communication device **3108b** by exchanging one or more messages or data packets. Furthermore, Visuphone **3104a** may send a first section of a data packet including first information such as header information to second communication device **3108b**. In an embodiment, Visuphone **3104a** may receive a message including acknowledgement information from second communication device **3108b**. In an embodiment, the acknowledgement message is received at first communication device **3102b**, when second communication device **3108b** includes an IVR application such as Visuphone **3104b** as shown in FIG. **31B**. The acknowledgement message may be received based on the first section of the data packet. Thereafter, Visuphone **3104a** of first communication device **3102b** may send a second section of the data packet including second information such as a payload. In an embodiment, the Visuphone **3104a** may exchange one or messages with Visuphone **3104b** or second communication device **3108a** in form of DTMF signals or tones.

As illustrated in FIG. **31D**, first communication device **3102c** can be connected to the PSTN **3110** through network **3112** or through a cellular network **3116**. Various service providers provide multiple or overlapping services to customers. For example, cable television service provider may also provide phone and network service, optical network provider may also provide phone or television services, WiMax service providers that provide phone service, and so forth. Network **3112** may be any service provider that provides such services, for example, but not limited to, cell phone services, wireless services, network services, cable television services, or various combinations of the above or other type of services.

First communication device **3102c** includes Visuphone **3104a** which displays data corresponding to the dialed phone number of second communication device **3108b** (or **3108a**). Further, Visuphone **3104a** may display a visual IVR menu corresponding to the audible IVR menu of the dialed phone number of second communication device **3108b** (or **3108a**). In an embodiment, the visual IVR menu may be displayed when a call is received from second communication device **3108b**. Thereafter, caller **3106** may select one or more options from the displayed visual IVR menu. In an embodiment, the visual IVR menu may have an associated identity (ID) or number. The visual IVR menu will indicate the version information of the visual IVR menu. In an embodiment, Visuphone **3104a** may send selection information including one or more options selected by caller **3106** to second communication device **3108b**. In an embodiment, Visuphone **3104a** may receive the audio/visual IVR menu from second com-

munication device **3108b** when a latest version of the visual IVR menu is not available at first communication device **3102c**. In an embodiment, the dialed second communication device **3108b** may request the information from the server of communication network **3100** when the information requested by Visuphone **3104a** is not available at second communication device **3108b**. Thereafter, second communication device **3108b** may send the information received from the server to Visuphone **3104a**. Visuphone **3104a** may further request and/or receive information from the dialed second communication device **3108b**. Further, Visuphone **3104a** may display the information at first communication device **3102c**. In an embodiment, Visuphone **3104a** may include version information. The version information may be a combination of numbers, alphabets or an alphanumeric code indicating a version of Visuphone **3104a**. Herein after, first communication device **3102** may be used to refer first communication device **3102a-c** collectively.

FIG. **32** illustrates an exemplary packet **3202** sent from first communication device **3102** (or device **3102**) to second communication device **3108**, in accordance with an embodiment of the present invention. In an embodiment, Visuphone **3104a** of first communication device **3102** may send the packet **3202** to second communication device **3108** for establishing a communication session when a data network such as the Internet is available. Examples of packet **3202** include but are not limited to an Internet Protocol version 4 (IPv4) packet, an Internet Protocol version 6 (IPv6) packet, and so forth. In an embodiment, packet **3202** includes a first section **3202a** and a second section **3202b**. First section **3202a** of packet **3202** includes first information. In an embodiment, first section **3202a** may include header information. Examples of the first information include, but are not limited to, a Visuphone version, a visual menu identity (ID) of the visual IVR menu associated with second communication device **3108**, an ACK bit, and so forth. The Visuphone version indicates the version information of Visuphone **3104a** present at first communication device **3102**. The visual menu ID indicates the identity information of the visual IVR menu associated with the dialed phone number of second communication device **3108**. In an embodiment, the ACK or acknowledgement bit may be used by second communication device **3108** (or **3108b**) to send an acknowledgement message. In an embodiment, the ACK bit may have a value such as 0 or 1. For example, second communication device **3108** may set the ACK bit or acknowledgement bit to 1 and send it back to first communication device **3102** as an acknowledgement message. A value 1 in the ACK bit indicates that the message is an acknowledgement message for a previously sent message or section of the packet. In an embodiment, second communication device **3108** sends the acknowledgement message when second communication device **3108** includes Visuphone **3104b** as shown in FIG. **31B**. The ACK bit set as 1 indicates that the packet sent from first communication device **3102** has been received at second communication device **3108**. In an embodiment of the invention, first section **3202a** may be a header section of IPv6 packet. The structure of header section or first section **3202a** is shown in FIG. **33**.

In an embodiment, second section **3202b** of packet **3202** may include second information. Examples of the second information include, but are not limited to, a user ID, user options (selected from the visual IVR menu), user profile information (last dialed details), and so forth. In an embodiment, the second section may include a data or payload section. The user ID is the identity information of caller **3106** dialing the phone number of second communication device **3108**. The user options indicate selection information includ-

ing the one or more options selected from the displayed visual IVR menu. Visuphone **3104a** displays the visual IVR menu associated with second communication device **3108** when the caller dials the phone number of second communication device **3108**. The user profile indicates the information related to previous communication session or activities of caller **3106** or first communication device **3102**. The user profile indicates information such as last dialed numbers, time of last call, duration of last call to the second communication device **3108**, access pattern of caller **3106**, and so forth. In an embodiment, second section **3202b** may be a payload or data section of IPv6 packet. In an embodiment, the information of first section **3202a** and second section **3202b** may be sent separately as two different packets by Visuphone **3104a**. In an embodiment first section **3202a** and second section **3202b** may be sent in form of DTMF tones or signals. The messages are sent in form of DTMF tones when the data network is not available.

FIG. **33** illustrates an exemplary structure of first section **3202a** of packet **3202** sent to second communication device **3108**, in accordance with an embodiment of the invention. In an embodiment, first section **3202a** of packet **3202** may be a header section of IPv6 packet. Further, first section **3202a** may include a plurality of fields. Example of plurality of fields include, but are not limited to, a packet version **3302**, a traffic class **3304**, a flow label **3306**, a payload length **3308**, a next header **3310**, a hop limit **3312**, a source address **3314**, a destination address **3316**, and so forth. Packet version **3302** indicates version information associated with packet **3202** such as IPv4, IPv6, and so forth. The version information may include numeric characters, alphabets or a combination thereof. In an embodiment of the invention, traffic class **3304** field may indicate whether the source device i.e. first communication device **3102** provides congestion control management or not. Flow label **3306** field may be used to provide real time applications special services. Payload length **3308** field may indicate the size or length of the payload or data section (second section **3202b**). Next header **3310** field points to next element or packet in the chain of packets when multiple packets are sent. Hop limit **3312** field may indicate the number of stops or hops the packet may take before reaching the final destination or second communication device **3108**. Source address **3314** field may include the address of first communication device **3102**. Destination address **3316** field may be address of second communication device **3108**. In an embodiment, destination address **3316** field may be the address of next hop of packet **3202**.

FIGS. **34A** and **34B** illustrates a flowchart for communicating among a plurality of communication devices, in accordance with an embodiment of the invention. As discussed with reference to the FIGS. **31A** and **31B**, communication network **3100** includes first communication device **3102**. Further, communication network **3100** includes second communication device **3108**. In an embodiment, first communication device **3102** may include Visuphone **3104a**. In an embodiment, second communication device may include an IVR application such as Visuphone. As shown in FIG. **31B**, second communication device **3108b** includes Visuphone **3104b**. In another embodiment, second communication device may not include Visuphone as shown in FIG. **31A**. Visuphone **3104a** of first communication device **3102a** may send one or more messages or packets to second communication device **3108**. The messages may be sent as Dual-Tone Multi-Frequency (DTMF) or tones depending on the availability of the data network. Similarly, Visuphone **3104b** may receive or send one or more messages/packets from/to first communication device **3102**. Further, Visuphone **3104** may display the visual

IVR menu associated with a phone number of second communication device **3108**. First communication device **3102** includes one or more visual IVR menus associated with a plurality of second communication devices.

Caller **3106** may dial a phone number of second communication device **3108**. In an embodiment, Visuphone **3104a** may display a visual IVR menu associated with the dialed second communication device **3108**. At step **3402**, Visuphone **3104a** of first communication device **3102** searches for a data network such as the Internet. At step **3404**, an availability of the data network is checked. When the data network is available the process continues to step **3408** else the process control goes to step **3406**. At step **3406**, Visuphone **3104a** sends a first section of the packet to second communication device **3108** such as second communication device **3108b** as DTMF signals or tones. As discussed with reference to FIG. **33**, first section may include a first information or header information. Thereafter, first communication device **3102** and second communication device **3108** may further communicate through the exchange of DTMF tones or signals.

At step **3408**, Visuphone **3104a** sends a first section of the packet as a data packet to second communication device **3108a** when the data network is available. In an embodiment, the data packet may be an IPv4 packet, an IPv6 packet, and so forth. As discussed with reference to FIG. **33**, the first section of the packet includes first information. Examples of the first information include, but are not limited to, a Visuphone version, a visual menu identity (ID) associated with the visual IVR menu corresponding to second communication device **3108**, an ACK bit, hop limit, payload length, traffic class, and so forth. The Visuphone version field indicates the version information of the Visuphone **3104a** present at first communication device **3102**. In an embodiment, the visual menu ID field may indicate the identity information of the visual IVR menu associated with the dialed phone number of second communication device **3108**. The ACK bit or acknowledgement bit may be used by second communication device **3108** to send an acknowledgement message from which the first section is received. In an embodiment, the ACK bit may have a value such as 0 or 1.

At step **3410**, it is checked, at second communication device **3108**, whether a Visuphone is available at second communication device **3108**. If the Visuphone is not available, first communication device **3102** and second communication device **3108** may communicate by exchanging messages/information as DTMF tones or signals else process control goes to step **3412**. At step **3412**, an acknowledgement message based on the first section is received from second communication device **3108**. In an embodiment, the acknowledgement message is received based on the first information of the first section. In an embodiment, Visuphone **3104b** of second communication device **3108b** sends the acknowledgement message to first communication device **3102**.

At step **3414**, Visuphone **3104a** sends a second section of the packet including second information to second communication device **3108** such as to second communication device **3108b**. Examples of the second information include, but are not limited to, a user ID, user options (selected from the visual IVR menu), user profile information (last dialed details), and so forth. The user ID is the identity information of caller **3106** who dials the phone number of second communication device **3108**. The user options indicate selection information including the one or more options selected from the displayed visual IVR menu. The visual IVR menu is associated with the phone number of second communication device **3108** dialed from first communication device **3102**.

Visuphone **3104a** may display the visual IVR menu associated with second communication device **3108**. The user profile indicates the information related to previous communication session or activities of caller **3106** or first communication device **3102**. The user profile indicates information such as last dialed numbers, time of last call, duration of last call to second communication device **3108**, and so forth.

In an embodiment, Visuphone **3104a** may send header information as a first section of the packet and data or payload as second section of the packet. In an embodiment, first communication device **3102** may send the second section of the packet after receiving an acknowledgement message from second communication device **3108**. In an embodiment, the first section and the second section of the packet may be sent as a single packet **3202**, as shown in FIG. **32**.

FIG. **35A** illustrates an exemplary communication network where a call is received at a device from a first party device, in accordance with an embodiment of the invention. A device **3502a** may receive a call from a plurality of first party devices **3508a-n** in a communication network **3500**. A person skilled in art will appreciate, that communication network **3500** may also include different types of devices. Further, communication network **3500** may include a plurality of device **3502**. First party devices **3508a-n** may initiate a call to connect to device **3502a**. First party devices **3508a-n** are devices which are capable of data/voice communication. Examples of first party devices **3508a-n** include, but are not limited to, a telephone, a computer, a laptop computer, a personal digital assistant (PDA), a mobile phone, and so forth. Each of first party devices **3508a-n** may have associated one or more phone numbers. Further, each of first party devices **3508a-n** may have audio or visual IVR menu corresponding to the associated one or more phone numbers. Various types of organization which implement audio IVR systems such as, but are not limited to, banks, hotels, fast-food outlets, utility services providers, corporate offices, mobile phone service providers, hospitals, and so forth. An agent or customer care executive, a person associated with the organizations may use first party devices **3508a-n** for initiating calls to devices **3502a-n**. Typically, the audible IVR menu provided by first party devices **3508a-n** comprises audible options or instructions. Further, the visual IVR menu includes one or more text and/or graphical representation of different nodes corresponding to different nodes of the audio IVR menu as displayed in FIG. **2A** and FIG. **2B**.

A caller **3506** may connect to a first party device of the first party devices **3508a-n** either by accepting a call from the calling first party device or by dialing a phone number of first party device **3508a**. After establishing a connection with first party device **3508a**, caller **3506** can interact with first party device **3508a** via the IVR menu associated with first party device **3508a**. Further, first party devices **3508a-n** can send information to device **3502a**. Similarly, device **3504a** may also request information from first party devices **3508a-n**. Device **3502a** can be a telecommunication device that can connect directly to a PSTN **3510**. A person skilled in the art will appreciate, that device **3502a** can also connect to a private telephone exchange.

A Visuphone **3504** of device **3502a** can display a visual IVR menu associated with the calling first party device. In an embodiment, Visuphone **3504** may display the visual IVR menu at device **3502a** even before accepting the call by caller **3506**. Thereafter, caller **3506** can select one or more options from the displayed visual IVR menu to obtain the required resource/information or service from the calling first party device **3508a**. Furthermore, Visuphone **3504** may display one or more communication options on a screen of device **3502a**.

Examples of the communication options include, but are not limited to, a conferencing option, a call forwarding option, a busy option, and so forth. Caller **3506** can select a communication option from the displayed one or more communication options. Based on the selection by caller **3506** a communication session may be established between device **3502a** and the calling first party device **3508a**. In an embodiment, when caller **3506** selects the 'conferencing' option, another device of communication network **3500** may be included in the call with first party device **3508a**.

In an embodiment of the invention, device **3502a** can request and/or receive updates from the server. This may happen in a case when requested information is not available on the calling first party device. Device **3502a** may also request information from first party device **3508a** from which the call is received.

FIG. **35B** illustrates another exemplary communication network in which an IVR menu is displayed when a call is received from a first party device, in accordance with an embodiment of the invention. As shown,

a device **3502b** can be a communication device that can be connected directly to a network **3514**. Examples of device **3502b** include, but are not limited to, a personal computer, a laptop, a mobile phone, a smart-phone, a fixed line telephone, a VOIP phone or other devices capable of voice or data communication. Device **3502b** may include various applications or computer programs such as Skype, Magic Jack etc, that enable caller **3506** to use device **3502b** for receiving and/or accepting call from first party devices **3508a-n** through PSTN **3510** over network **3514** through a gateway **3512**. Network **3514** may include any wired or wireless network, such as but not limited to, LAN, WAN, a Wi-Fi network, and so forth. As discussed with reference to FIG. **35A**, first party devices **3508a-n** presents the audible IVR to device **3502b**. Visuphone **3504** will function in a similar manner as described in FIG. **35A**.

As shown in FIG. **35C**, a device **3502c** can be connected to PSTN **3510** through network **3514** or through a cellular network **3516**. Various service providers provide multiple or overlapping services to customers. For example, cable television service provider may also provide phone and network service, optical network provider may also provide phone or television services, WiMax service providers that provide phone service, and so forth. Network **3514** may be any service provider that provides such services, for example, but not limited to, cell phone services, wireless services, network services, cable television services, or various combinations of the above or other type of services. In an embodiment of the invention, Visuphone **3504** may display one or more communication options at device **3502c** along with the visual IVR menu of the associated calling phone number of first party device **3508a**. Caller **3506** may select a communication option from the displayed communication options for interacting with the calling first party device **3508a**. In an embodiment, Visuphone **3504** may receive the visual IVR menu from first party device **3508a**. In an embodiment, calling first party device **3508a** may request the information requested by Visuphone **3504** or caller **3506**, from the server of communication network **3500**. Thereafter, calling first party device **3508a** may send the information received from the server to Visuphone **3504**. Visuphone **3504** may further request and/or receive information from calling first party device **3508a**. Further, Visuphone **3504** may display the information at device **3502c**.

FIG. **36** illustrates yet another exemplary communication network in which an IVR is displayed when a call is received at a device, in accordance with an embodiment of the inven-

tion. As discussed with reference to FIG. 35A, communication network 3500 includes first party devices 3508a-n which may initiate a call to the phone number associated with device 3502a. Further, communication network 3500 may include a third party device 3602. In an embodiment, communication network 3500 may include more than one third party device 3602. Device 3502a includes Visuphone 3504 that can receive the call from first party device 3508. Visuphone 3504 may further display a visual IVR menu associated with the calling first party device 3508. In an embodiment, device 3502a may be referred as a second party device.

Further, Visuphone 3504 can highlight an option or node in the visual IVR menu. The highlighted option represents the exact position of first party device 3508 within the visual IVR menu from where the call is initiated. For example, in case of a bank, if a person from insurance department initiates a call to a mobile phone, then the node representing the insurance is highlighted in the visual IVR menu of the bank displayed at the mobile phone. Therefore, caller 3506 can know exactly from which department within the organization the call is coming from. Accordingly, caller 3506 may act or opt to attend or reject the call from first party device 3508.

Further, Visuphone 3504 may display one or more communication options on a screen of device 3502a. Examples of the one or more communication options can include, but are not limited to, a conferencing option, a call forwarding option, a busy option, and so forth. Caller 3506 may select an option from the displayed communication options. Visuphone 3504 may establish a connection with a third party device based on the selection of the communication option by caller 3506. Third party device 3602 may be a device 3502, a first party device of first party devices 3508a-n, a server, and so forth depending on the selection of the communication option. Further, third party device 3602 may have an associated phone number.

In an embodiment, when caller 3506 selects a ‘conferencing’ option from the displayed one or more communication options then third party device 3602 may be included in the call. Now third party device 3602, device 3502a, and first party device 3508a from which the call was received initially may communicate through a conference call and can interact with each other. Thereafter, all three types of devices in the conference call may further request or receive information from each other. In an embodiment, third party device 3602 may be another device of communication network 3500. In an embodiment, Visuphone 3504 may further display a visual IVR menu associated with third party device 3602. In an embodiment, Visuphone 3504 of the device 3502a may receive the visual IVR menu associated with the phone number of third party device 3602. In an exemplary scenario, a user receives a call at a first mobile phone from an executive of the insurance department of a bank. The user may select a ‘conferencing’ option and can include another user of a second mobile phone who might be interested in knowing about the insurance policies offered by the executive. In an embodiment, caller 3506 of device 3502a may opt to leave the conference call in between of the call. Thereafter, first party device 3508a and third party device 3602 may continue with the call.

In an embodiment, caller 3506 may select a ‘call forwarding’ option of the displayed one or more communication options to forward the call coming from first party device 3508a to third party device 3602. Thereafter, a user of third party device 3602 may interact with first party device 3508a. For example, when a user of first mobile phone receives a call from a pizzeria, then a visual IVR menu of the pizzeria can be displayed at the mobile phone along with various communi-

cation options. The user may forward the call to a second mobile phone by selecting the ‘call forwarding’ option. Now, the call will be between the second mobile phone and the pizzeria. In an embodiment, third party device 3602 may include a Visuphone or IVR application. In another embodiment, third party device 3602 may include one or more audio and/or visual IVR menus. In an embodiment, a visual IVR menu associated with a phone number of third party device 3602 may be displayed on device 3502a. Further, Visuphone 3504 may receive the visual IVR menu associated with the third party device from third party device 3602.

FIG. 37 illustrates an exemplary visual IVR menu 3702 along with one or more communication options at device 3502a, in accordance with an embodiment of the invention. As discussed with reference to FIGS. 35A and 36, Visuphone 3504 may display the visual IVR menu 3702 associated with the phone number of calling first party device 3508 on the screen of device 3502a. The visual IVR menu is displayed with added graphics on the screen of device 3502. Visual IVR menu 3702 may include one or more options corresponding to every node in calling first party device 3508. It is well known that graphics are easier to learn and are faster to recognize than words. Therefore, graphics are used in various computerized device interfaces. Various types of graphics can be displayed for example, animated icons, icons that highlight or animate when the node is highlighted, and so forth. The graphics may be displayed for each node or a few nodes based on the usability of visual IVR menu 3702. For example, for node 3716 of home delivery, an icon of house may be displayed. In an embodiment of the invention, visual IVR menu 3702 can be customized to display only the text, only the icons or both. Furthermore, caller 3506 can suggest or use various icons based on his preferences. The visual IVR menu is specific to first party device 3508 from which call is received.

Further, each of first party devices 3508a-n may have more than one audio IVR menus. Therefore, different visual IVR menu corresponding to the one or more audio IVR menus is possible for each of first party devices 3508a-n. In an embodiment, device 3502 may include more than one visual IVR menus for each first party device of first party devices 3508a-n based on the time. Therefore, different visual IVR menus corresponding to a first party device 3508 might be presented to caller 3506 depending on the time of dialing to first party device 3508. In an exemplary scenario, in a hotel, the food items in a daytime menu card may be different from a night menu card. Accordingly, the options in the visual IVR menu may differ. Therefore, the visual IVR menus for daytime and night can be different for the hotel. When caller 3506 receives a call from the phone number of the hotel in daytime, a daytime visual IVR menu can be displayed at device 3502, and if caller 3506 receives a call at night, a different menu can be displayed at device 3502. Therefore, a visual IVR menu of the hotel displayed at device 3502 for a call received at 1 PM may be different then the visual IVR menu displayed for another call received at 5 PM.

Further, Visuphone 3504 may display the one or more communication options 3720a-n on the screen of device 3502. Examples of one or more communication options 3720a-n include, but are not limited to, a conferencing option, a call forwarding option, a busy option, and so forth. In an embodiment, when caller 3506 selects a ‘busy’ option from communication options 3720a-n, a text or audio message may be sent to calling first party device 3508. For example, when a user receives a call from a bank and selects the ‘busy’ option from the displayed visual IVR menu of the calling bank, then a customized or predefined message such as “I am

61

busy right now, so please call later” can be sent to the bank. In an embodiment, the message may be an audio message.

In an embodiment, when caller **3506** accepts the call from first party device **3508**, a communication session is established between device **3502** and calling first party device **3508**. After communication session establishment, Visu- 5 phone **3504** of device **3502** may request and/or receive information from calling first party device **102**. In an embodiment, caller **3506** may include third party device **3602** by selecting ‘conferencing’ option from displayed communication options **3720a-n**. Thereafter, the three devices i.e. first party device **3508**, second party device **3502**, and third party device **3602** may have a conference call and can communicate with each other. In an embodiment, caller **3506** may include more than one third party device **3602** in the conference call. In an embodiment, third party device **3602** may include another communication device of communication network **3500** in the conference call. In another embodiment, the calling first party device such as first party device **3508a** may include another first party device such as a first party device **3508b** in the conference call. In another embodiment, first party device **3508** from which call is received may connect device **3502** to another first party device **3508b** during the call.

FIG. **38** illustrates another exemplary visual IVR menu **3802** along with one or more communication options at device **3502a**, in accordance with an embodiment of the invention. Visual IVR menu **3802** is a visual menu corresponding to an audio IVR menu of a bank. Visual IVR menu **3802** includes one or more options corresponding to every node in the audible IVR menu when the calling first party is the bank or an executive of the bank. Though not shown, nodes of visual IVR menu **3802** may be represented using graphics such as, animated icons, icons that highlight or animate when the node is highlighted, and so forth. Further, graphics may be displayed for each node or a few nodes based on the usability of visual IVR menu **3802**. Visual IVR menu **3802** includes nodes such as personal banking node **3806**, NRI banking node **3808**. Caller **3506** can choose NRI banking by pressing a combination 1-3. Thereafter, caller **3506** can select investment option by pressing 2. Furthermore, caller **3506** can suggest or use various icons based on his preferences. The visual IVR menu is specific to a destination. For example, hospitals will have different IVR menu than that of the bank. In an embodiment, one or more communication options **3720a-n** may also be displayed on the screen of device **3502**. Caller **3506** can select a communication option of displayed communication options **3720a-n**. Visuphone **104** may include a third party device as shown in FIG. **36** based on selection of the communication option.

Another embodiment of the invention allow visual IVR menu for calls received at a conventional home telephone. FIG. **39** illustrates the presentation of the visual IVR menu when a phone connection is associated with a wide band internet ‘smart’ modem. A phone **3904** connected to a PSTN **3908** and through a gateway **3916** to the Internet network **3918** is shown in FIG. **39**. A first party device **3508a** can call a phone number of the phone **3904**. Network **3918** may be any service provider that provides services, for example, but not limited to, telephone services, cell phone services, wireless services, Internet services, cable television services, or various combinations of the above or other type of services. An embodiment of the invention allow visual IVR menu for calls received at a conventional home telephone.

Further, the connection to network **3918** is associated with a wide band Internet ‘smart’ modem **3906**. Phone **3904** may be a regular phone, such as a landline phone or a cordless landline phone. Modem **3906** may be a Digital Subscriber

62

Link (DSL) modem or a cable modem that connects the home device to the Internet and/or computer network. Modem **3906** is connected to a service provider, and can provide the home devices with telephone, Internet and television services. Modem **3906** may provide both wired and wireless connections. Modem **3906** provides the home with the Internet through wire **3910** to a computer **3902**, or through a Wi-Fi connection. Modem **3906** comprises the ability to detect and recognize the calls received by phone **3904**. The phone number of the call received by phone **3904** to establish connection are then compared with phone numbers stored in a database, such as visual menu database **308**. Therefore, in case the calling phone number corresponds to first party device **3508a** with an audible IVR menu, and also when associated visual IVR menu exists then, modem **3906** may provide the visual IVR menu on computer **3902** connected to it. Moreover, modem **3906** may use private web sites to present the visual IVR menu or just provide the phone number of the calling first party device **3508a** to computer **3902**. Thereafter, a software tool on computer **3902** may present the visual IVR menu on the screen of the computer **3902**.

Once the communication session is established between first party device **3508a** and phone **3904**, the ‘smart’ modem **3906** will continue to monitor the numbers dialed or received by phone **3904** to browse or advance the visual IVR menu accordingly. Furthermore, the numbers dialed or received may be stored for future processing such as highlighting previous selections in the visual IVR menu, providing customized visual IVR menu and so forth. The visual IVR menu system comprising computer **3902** and modem **3906** may incorporate additional enhancements as presented before.

In another embodiment of the invention, a house television **3912** may be used to present the visual IVR menu. In various houses modem **3906** decodes television signals and transfers it to a set-top box **3914** that provides signals to television **3912**. The visual IVR menu may be presented on a channel dedicated for IVR. Therefore, when phone **3904** is used to receive a call, modem **3906** can detect it and present the visual IVR menu corresponding to the phone number of the calling first party device **3508a** on the designated channel of the television **3912**. Modem **3906** may further display one or more communication options **3720a-n** on the designated channel of the television **3912**. Further, all the options described before can be provided now using the screen of the television **3912** for the visual IVR menu. The caller selection can be done by using the simple phone **3904** or alternatively using TV **3912**, set top box **3914** remote control. Further, television **3912** screen may be used to present the visual IVR menu in a few alternatives ways. For example, a device provided by a company named RokuInc., allows streaming of content from the Internet to television. Most set-top boxes now have an Internet connection or telephone connections. Furthermore, various devices such as some Digital Versatile Disc (DVD) players, and video game players or controllers such as Xbox or Playstation, can be connected to the Internet. Each of those devices may allow the ‘smart’ modem **3906** to provide a visual IVR menu and/or the one or more communication options **3720a-n** on the screens of television **3912**.

FIG. **40** illustrates a flowchart for providing enhanced telephony when a call is received, in accordance with an embodiment of the invention. First party devices **3508a-n** may call a phone number of device **3502**. Device **3502** may receive a call from the phone number of first party devices **3508a-n**. Caller **106** may accept call at device **3502** to connect or interact with first party devices **3508a-n** and/or third party device **3602**. First party devices **3508a-n** may include an audible IVR menu for interaction with caller **3506**. Further, device **3502**

may include Visuphone **3504** to display a visual IVR menu **3702** associated with a phone number of a calling first party device **3508**. Further, Visuphone **3504** may display the one or more communication options **3720a-n** at device **3502**, as discussed with reference to the FIG. 37. Visuphone **3504** may establish a communication session with the phone number of calling first party device **3502** by accepting the call. In an exemplary scenario, a user of the mobile phone receives a call from a bank, then ‘conferencing’ and ‘call forwarding’ options may also be displayed along with the visual IVR menu of the bank on the mobile phone. The user may select a ‘conferencing’ option to include another mobile device in the conference call. Similarly, the user may select the ‘call forwarding’ option to forward the call to another communication device or a server in communication network **3500**.

At step **4002**, a call from a phone number of a first party device **3508** such as a first party device **3508a**, is received. The call may be received by Visuphone **3504** of device **3502**. First party device **3508a** may initiate a call to device **3504** by dialing a phone number of device **3502**. At step **4004**, the phone number of first party device **3508a** is compared with a plurality of phone numbers stored at device **104**. Visuphone **3504** may compare the phone number of first party device **3508a** with the stored phone numbers.

A visual menu database may store the one or more phone numbers of first party devices **3508a-n**. Further, the visual menu database stores one or more visual IVR menus associated with the phone numbers of first party devices **3508a-n**. In an embodiment, it may be checked whether a visual IVR menu associated with the phone number of the calling first party device **3508a** is present in the visual menu database of device **3502**. If the visual IVR menu is not present, device **3502** may receive the visual IVR menu associated with first party device **3508a** from first party device **3508a**. In an embodiment, the visual IVR menu associated with first party device **3508a** may be received from the server.

At step **4006**, visual IVR menu associated with the calling first party device **3508a** is displayed. The visual IVR menu may be displayed at the display of device **3502**. The visual IVR menu includes one or more graphics and/or text options corresponding to different nodes as shown in FIG. 37. At step **4008**, one or more communication options **3720a-n** is displayed. One or more communication options **3720a-n** may be displayed at a display of device **3502**. Examples of one or more communication options **3720a-n** include, but are not limited to, a conferencing option, a call forwarding option, a busy option, and so forth. At step **3710**, caller **3506** of device **3502** may select a communication option of the displayed one or more communication options **3720a-n**. At step **4012**, a communication session is established based on the selection by caller **3506**. In an embodiment, caller **3506** may select the ‘conferencing’ option, to establish the communication session between first party device **3508a**, device **3502** and third party device **3602**. Thereafter, all the three devices can communicate/interact with each other and may request/receive information from each other. In another embodiment, caller **3506** may forward the call of first party device **3502a** to another communication device of communication network **3500** by selecting the ‘call forwarding’ option. In an embodiment, the call may be forwarded to a server of communication network **3500**. In another embodiment, caller **3506** may select the ‘busy’ option when caller **3506** cannot attend the call. Selecting the ‘busy’ option by the user may send a predefined audio/text message to calling first party device **3508a**.

In another embodiment of the invention, a method is disclosed for displaying a visual IVR menu associated with a phone number of a first party device from which a call is received, at the device.

In an embodiment of the invention, more than one visual IVR menus associated with the phone numbers of the first party devices may be displayed at a communication device. In an embodiment, the Visuphone may display the one or more visual IVR menus at the communication device. In another embodiment of the invention, the user may request information from more than one first party device simultaneously. The user may interact with more than one visual IVR menu associated with different first party devices. In an embodiment, the one or more visual IVR menus may be associated with the second party device. For example: a user receives a call from an insurance department of a bank offering some insurance policy to the user. When the user accepts the call a visual IVR menu associated with the bank with the insurance department highlighted is displayed on the screen of the device. During the call, if the user wish to check his/her account balance to take a decision regarding insurance policies. The user may check his/her account balance by selecting the personal banking option from the visual IVR menu of the bank. As soon as the user selects this option another visual IVR menu of the personal banking will be displayed on the screen of the communication device. Thereafter, the user may simultaneously interact with both the visual IVR menus.

In an embodiment of the invention, the user may request information from more than one first party device simultaneously. The user may interact with more than one visual IVR menus associated with different first party devices. For example: a user gets a call from a restaurant offering different types of cuisine. When the user accepts the call a visual IVR menu associated with the restaurant is displayed at the screen of the device. During the call, if the user wishes to check menus of two or more cuisines, the user may select from the main visual IVR menu of the restaurant. Based on the selection by the user, the two or more visual IVR menus may be displayed at the device. Thereafter, the user may simultaneously interact with the displayed visual IVR menus.

According to an embodiment of the invention, portable devices such as smart phones, mobile phones, land line phone, and so forth may also include Visuphone and can connect to external devices. Usually the display screen of portable device is small and not so user friendly. The Visuphone of such devices may be configured to automatically detect external devices such as a laptop, a computer, an LCD screen etc present in its vicinity. Further, the detected electronic devices are configured to connect with the portable devices. This functionality of the Visuphone has been explained in detail using FIGS. 41 to FIG. 64.

FIG. 41 illustrates an environment **4100** where a device may be connected to an external device, according to an embodiment of the invention. Environment **4100** includes a portable device **4102** including a Visuphone **4104**. Examples of portable device **4102** include but are not limited to a mobile phone, a smart phone, a Personal Desktop Assistant (PDA), a tablet Personal Computer (PC), and so forth. Environment **4100** further includes a plurality of external devices **4106a-n**. Portable device **4102** may be used for data and voice communications. In an embodiment of the invention, portable device **4102** may include an Operating System (OS) such as, but not limited to, Windows Mobile, Apple iOS, Google Android, Symbian, and so forth. Portable device **4102** may be connected to multiple external devices **3506a-n**. Examples of external devices **3506a-n** include, but are not limited to, a

65

display screen, a laptop, an electronic musical instrument, a keyboard, a mouse, and so forth.

Portable device **4102** may connect to external devices **4106a-n** by using Bluetooth, Wi-Fi, Infrared, or other wireless protocols. Further, portable device **4102** may connect to external devices **4106a-n** by using an Ethernet cable, a video cable, Universal Serial Bus (USB), and so forth. When connected to the external device such as a display screen, the display of the external device may be used to display the content of screen of portable device **4102**. Moreover, external device **4106b** such as a mouse connected to portable device **4102**, can be used to provide inputs that are reflected on the display of the external device. As a result, portable device **4102** can act as a universal communication hub that can enable interaction of multiple external devices **4106a-n** among each other.

FIG. **42** illustrates exemplary functioning of portable device **4102** in the environment discussed in conjunction with FIG. **41**, in accordance with an embodiment of the invention. As shown, a display screen **4202**, a keyboard **4204**, and a mouse **4206** can be connected through portable device **4102**. Therefore, the screen of portable device **4102** is displayed on a larger screen of display screen **4202**. Moreover, a user can use keyboard **4204** and mouse **4206** to access the information through portable device **4102**. For example, in this configuration, the user can browse the Internet by using display screen **202**, keyboard **204**, and mouse **206**, while portable device **4102** provides the Internet connectivity. Therefore, a computer other than portable device **4102** may not be required by the user. As a result, the user can carry portable device **4102** and use it with various external devices as desired.

In an embodiment of the invention, portable device **4102a** such as a smart phone or mobile phone may detect and connect to a laptop **4302** as shown in FIG. **43**. The connection between portable device **4102a** and laptop **4302** may be wired such as via a USB wire or it can be wireless such as via Bluetooth or Wi-Fi. Thereafter, portable device **4102a** may use display of laptop **4302**. Further, laptop **4302** may be used to control one or more functions of portable device **4102a** and vice versa. For example, user can use one or more keys of laptop **4302** may be used to access phone book of the smart phone or to dial a phone number.

In another embodiment of the invention, portable device **4102a** may detect a large display screen **4402** as shown in FIG. **44**. Further, portable device **4102a** may use Bluetooth, USB wire, and so forth to connect to large screen **4402**. The large screen **4402** may be a Light Emitting Diode (LED) display screen, a Liquid Crystal Display (LCD) screen, and so forth. Usually, Portable devices such as mobile phones, smart phones, wired telephones etc. have either a small display or limited display capabilities. In such cases, portable devices include a Visuphone. The Visuphone may be further configured to detect and connect portable device **4102** to one or more external devices such as large screen **4402**. Once configured, the Visuphone can detect large display **4402** and can connect to it via Bluetooth. In an embodiment, the portable device **4102a** may connect to external devices **4106a-n** using Near Field Communication (NFC) protocol. Further, when portable device **4102a** is video conferencing with another portable device, the video can be displayed at large screen **4402**. For example, when the smart phone is in video call with another phone, the video of the user at another phone will be displayed at the large screen.

In another embodiment of the invention, portable device such as a smart phone **4102a** may detect and connect to a television screen **4502** as shown in FIG. **45**. Visuphone **4104**

66

can detect television screen **4502**. In this case, television screen **4502** may be used to display the screen of portable device **4102a** such as a mobile device. Therefore, when the user is connected to television **4502**, screen of television **4502** can be used to access various functions of portable device **4102** such as, but are not limited to, call receiving, dialing, browsing the phonebook, typing a message, browsing the Internet, and so forth. This functionality increases the comfort in using the small form factor of portable device **4102**.

In another embodiment of the invention, Visuphone **4104** may detect a picture frame **4602** and connect it to portable device **4102a** it as shown in FIG. **46**. The connection between portable device **4102a** (the smart phone) and picture frame **4602** can be wireless or wired. The wireless connection may be established by using Bluetooth, Wi-Fi, NFC, and so forth. The wired connection may be established via USB or using a cable wire. In an embodiment, picture frame **4602** may be a digital picture frame. The digital picture frame is a picture frame which may be used to display images or photos without the need of printing or using them on computer. Once connected, display of picture frame **4602** may be used to display screen of portable device **4102a** such as a mobile phone.

In another embodiment of the invention, portable device **4102a** may detect and connect to a Global Positioning System (GPS) navigation system **4702** as shown in FIG. **47**. Visuphone **4104** detects GPS navigation system **4702**. Therefore, when the user is connected to GPS navigation system **4702**, screen of GPS navigation system **4702** may be used as display of portable device **4102a** such as a mobile device. Further, screen of GPS navigation system **4702** can be used to access various functions of portable device **4102a** such as call receiving, browsing the phonebook, browsing the Internet, and so forth. This functionality increases the comfort in using portable device **4102a** such as the mobile phone which has limited display.

In yet another embodiment of the invention, smart phone **4102a** can detect and connect to a projector **4802** as shown in FIG. **48**. Visuphone **4104** detects the availability of projector **4802**. Further, Visuphone **4104** may connect to projector **4802** using any of wired or wireless connection. Further, projector **4802** is configured to connect to connect to Visuphone **4104** of smart phone **4102a**. Projector **4802** may be connected to a display **4804**. Similarly, the connection between projector **4802** and display **4804** can be wired or wireless. Further, projector **4802** can project the display of smart phone **4102a** on display **4804**. Further, one or more functions of projector **4802** may be controlled by using connected smart phone **4102a**.

FIG. **49** illustrates exemplary display of an Interactive Voice Response (IVR) menu on a large display screen **4902** connected to a portable device **4102**, in accordance with an embodiment of the invention. Large display screen **4902** can be a screen of any of external devices **4106a-n**. Portable device **4102** can be a smart phone, a mobile phone, a pager, and so forth. A visual IVR menu **4904a** is a visual menu including one or more options at portable device **4102**. A visual IVR menu **4904b** is a visual menu at large display screen **4902** corresponding to visual IVR menu **4904a**. Displaying visual IVR menu of mobile phone on large display screen **4902** enhances visibility.

FIG. **50** illustrates a block diagram of portable device **4102**, in accordance with an embodiment of the invention. Herein after, portable device **4102** may be referred to as device **4102**. Device **4102** can connect to Public Switched Telephone Network (PSTN) **5016** through a radio interface **5012** in a wired or wireless manner. For example, radio interface **5012** may provide 2G, 3G, and/or 4G connectivity in case of device

67

4102 being a mobile phone. Moreover, network interface 5014 can be used to connect device 4102 to network 5018. Examples of network 5018 include wireless or wired networks such as Local Area Network (LAN), Personal Area Network (PAN), or other specialized networks. FIG. 51 shows when network 5018 is a wireless network 5102. Network interface 5014 may allow connectivity through various protocols such as TCP/IP, Bluetooth, acoustic signals, or other types of radio signals. For example, device 4102 may connect to a television through Bluetooth for displaying the contents of device 4102.

Device 4102 includes a display 5002 to output graphical information to the user. In an embodiment of the invention, display 5002 may include a touch sensitive screen. A memory 5006 of device 4102 stores various programs, data and/or instructions that can be executed by a processor 5004. Examples of memory 5006 include, but are not limited to, a Random Access Memory (RAM), a Read Only Memory (ROM), a hard disk, and so forth. A person skilled in the art will appreciate that other types of computer-readable media which can store data that is accessible by device 4102, such as magnetic cassettes, flash memory cards, digital video disks, and the like, may also be used by device 4102. Further, memory 5006 may include an OS 5010. Further, other applications such as instant messaging application, browser, and so forth may be available on device 4102. Processor 5004 may include a connection manager 5008 that enables device 4102 to connect to external devices 4106a-n through network interface 5014. In an embodiment of the invention, connection manager 5008 may be implemented as a second processor in device 4102.

Device 4102 includes a system bus 5020 for connecting the components. Examples of system bus 5020 include several types of bus structures including a memory bus or memory controller, a peripheral bus, or a local bus using any of a variety of bus architectures.

In another embodiment of the invention, a portable device may be connected to a user device as shown in FIG. 52. As shown, an environment 5200 includes a portable device 5202 that can be used by a user through a user device 5204. Further, portable device 5202 may include a Visuphone 5208 for connecting and establishing a communication with user device 5204. Examples of user device 5204 include but are not limited to a mobile phone, a smart phone, a Personal Digital Assistant (PDA), a tablet Personal Computer (PC), and so forth. User device 5204 may be used for data and/or voice communications over a PSTN, mobile network, the Internet, the Ethernet, and so forth. Further, portable device 5202 is configured to connect to multiple external devices 5206a-n. Furthermore, user device 5204 may be connected to multiple external devices 5206a-n and communicate with any of external device 5206 through portable device 5202. User device 5204 is configured to connect with portable device 5202. Similarly, multiple external devices 5206a-n are configured to connect to portable device 5202.

In an embodiment of the invention, portable device 5202 may include an Operating System (OS) such as, but not limited to, Windows Mobile, Apple iOS, Google Android, Symbian, and so forth. Examples of external devices 5206a-n include, but are not limited to, a display screen, a keyboard, a mouse, an LED screen, a Laptop, and so forth. In an embodiment of the invention, portable device 5202 may include a dock for receiving and connecting to user device 5204. In an embodiment, user device 5204 may include a Visuphone.

Portable device 5202 may connect to external devices 5206a-n by using Bluetooth, Wi-Fi, Infrared, or other wireless protocols. Further, Visuphone 5208 is configured to con-

68

nect to any of external devices 5202a-n. Further, portable device 5202 may connect to external devices 5206a-n by using an Ethernet cable, a video cable, Universal Serial Bus (USB), and so forth. Therefore, the display on the screen of portable device 5202 can be presented on external device 5206a such as a display screen. Moreover, external device 5206b such as a mouse connected to portable device 5202 can be used to provide inputs that is reflected on the display screen. As a result, portable device 5202 acts as a universal communication hub that can enable interaction of multiple external devices 5206a-n among each other.

Further, as shown in FIG. 53, user device 5204 may be connected to portable device 5202 via a network 5302. Network 5302 can be the Internet, LAN, MAN, and so forth. In an embodiment, user device 5204 and portable device 5202 may be separated by a large distance. Further, user device 5204 is configured to connect to portable device 5202. Further, Visuphone 5208 is configured to search for available one or more devices such as external devices 5206a-n and user device 5204.

FIG. 54 illustrates exemplary functioning of portable device 5202 connected to a mobile phone 5402 in the environment as discussed in conjunction with FIG. 52 or FIG. 53. As shown, user device 5204 such as mobile phone 5402 may connect to display screen 4202, keyboard 4204, and mouse 4206 of the computer through portable device 5202. Therefore, the screen of mobile phone 5402 is displayed on a larger screen of display screen 4202. Moreover, a user can use keyboard 4204 and mouse 4206 to access the information through portable device 5202. For example, in this configuration, the user can browse the Internet by using display screen 4202, keyboard 4204, and mouse 4206, while mobile phone 5402 provides the Internet connectivity and portable device 5202 provides the connectivity among mobile phone 5402 (or user device 5204), display 4202, keyboard 4204 and mouse 4206. Therefore, a computer other than mobile phone 5402 and portable device 5202 may not be required by the user. In an embodiment, mobile phone 5402 (or user device 5204) may not include a Visuphone.

In an embodiment of the invention, portable device 5202 can provide connectivity to multiple user devices. For example, in a home environment, portable device 5202 may detect multiple mobile phones and wired phone. Therefore, the screen of a mobile phone may be displayed on a television near to that mobile phone. In another embodiment of the invention, portable device 5202 may enable communication among multiple user devices. Further, the multiple user devices are configured to connect to portable device 5202.

FIG. 55 illustrates an exemplary functioning of portable device 5202 connected to mobile phone 5402 and a projector 5502 in the environment as discussed in conjunction with FIG. 52 or FIG. 53. Portable device 5202 may be connected to projector 5502, and to a user device such as mobile phone 5402. Further, projector 5502 may be connected to a bigger display 5504. Once all the devices are connected, display of mobile phone 5402 may be displayed on bigger display screen 5504. Visuphone 5208 of portable device 5202 will detect and connect the configured devices i.e. mobile phone 5402 (or user device) and projector 5502. Thereafter, one or more functions of mobile phone 5502 can be controlled by using projector 5502 and vice versa.

FIG. 56 illustrates another exemplary functioning of portable device 5202 connected to mobile phone 5402 and large screen 4402 in environment 5200, in accordance with an embodiment of the invention. As shown Visuphone 5208 of portable device 5202 may detect an external device such as a large screen 4402. A user device such as a mobile phone 5402

69

can be connected to large screen 4402 via portable device 5202. Mobile phone 5402 is configured to connect with portable device 5202. Similarly, large screen 4402 is also configured to connect to portable device 5202. Further, the connection between portable device 5202 and mobile phone 5402 can be wired or wireless. Furthermore, the connection between portable device 5202 and large screen 4402 can be wired or wireless. Thereafter, display of mobile phone 5402 may be displayed on large screen 4402 after being connected to portable device 5202.

In an embodiment of the invention, external device 5206a-n such as a television 4502 may be connected to user device such as mobile phone 5402 via portable device 5202 as shown in FIG. 57. Further, mobile phone 5402 and television 4502 are configured to connect with portable device 5202. In an embodiment of the invention, mobile phone 5402 may include a Visuphone. Though not shown, any user device other than mobile phone 5402 may be connected to portable device 5202.

FIG. 58 illustrates exemplary functioning of portable device 5202 connected to mobile phone 5402 and a laptop 4302 in the environment of FIG. 52 or FIG. 53, in accordance with another embodiment of the invention. A communication session between mobile phone 5402 and laptop 4302 may be established via portable device 5202. Mobile phone 5402 is configured to connect with portable device 5202. Similarly, laptop 4302 is also configured to connect to portable device 5202. After getting connected to each other via portable device 5202 contents of mobile phone 5402 may be displayed on screen of laptop 4302.

In another embodiment of the invention, an external device such as picture frame 4602 may be connected to a user device such as a wired telephone 5902 via portable device 5202 as shown in FIG. 59. As shown, Visuphone 5208 of portable device 5202 may detect an external device such as wired telephone 5802 and connect to it. Further, Visuphone 5208 may detect and connect to an external device such as picture frame 4602.

According to yet another embodiment of the invention, external device such as a GPS navigation system 4702 may be connected to a user device such as mobile phone 5402 via portable device 5202 as shown in FIG. 60. Both the devices i.e. GPS navigation system 4702 and mobile phone 5402 are configured to connect to portable device 5202. Once connected to portable device 5202, contents of mobile phone 5402 may be displayed by using screen of GPS navigation system 4702. For example, when a call is received at mobile phone 5402, an IVR menu associated with the calling party may be displayed at screen of GPS navigation system 4702.

FIG. 61 illustrates an exemplary display of a visual Interactive Voice Response (IVR) menu on a large display screen 6102 connected to a portable device such as the smart phone 6106, in accordance with an embodiment of the invention. Display 6104a is a display of a visual IVR menu on smart phone 6106. Display 6104b is the display of the visual IVR menu on large display screen 6102 corresponding to display 6104a of smart phone 6106.

FIG. 62 illustrates a block diagram of portable device 5202, in accordance with an embodiment of the invention. Network interface 6210 can be used to connect portable device 5202 to network 6212. Examples of network 6212 include wireless or wired networks such as Local Area Network (LAN), Personal Area Network (PAN), Bluetooth, or other specialized networks. Network interface 6210 may allow connectivity through various protocols such as TCP/IP, Bluetooth, acoustic signals, or other types of radio signals. For example, portable device 5202 may connect a mobile phone to a television

70

through a Bluetooth communication link. As a result, the contents on screen of the mobile phone can be displayed on the television screen which is larger than that of the mobile phone. In an embodiment of the invention, portable device 5202 can use different protocols for communicating with different devices based on their capabilities. For example, portable device 5202 may connect to a mobile phone through Bluetooth and the television through Wi-Fi.

Portable device 5202 includes a memory 6204 to store various programs, data and/or instructions that can be executed by a processor 6202. Examples of memory 6204 include, but are not limited to, a Random Access Memory (RAM), a Read Only Memory (ROM), a hard disk, and so forth. A person skilled in the art will appreciate that other types of computer-readable media which can store data that is accessible by portable device 5202, such as magnetic cassettes, flash memory cards, digital video disks, and the like, may also be used by portable device 5202. Memory 6204 may include an OS 6208. Further, other applications such as instant messaging application, browser, and so forth may be available on portable device 5202. Processor 6202 may include a connection manager 6206 that enables portable device 5202 to connect to external devices 5206a-n through network interface 6210. In an embodiment of the invention, connection manager 6206 may be implemented as a second processor in portable device 5202.

Device 5202 includes a system bus 6214 for connecting the components. Examples of system bus 6214 include several types of bus structures including a memory bus or memory controller, a peripheral bus, or a local bus using any of a variety of bus architectures.

FIG. 63 is a flowchart illustrating the functioning of portable device 4102 in accordance with an embodiment of the invention. As discussed with reference to FIG. 41, portable device 4102 includes a Visuphone 4104. Further, portable device 4102 is configured to detect and connect to any one of external devices 4106a-n.

At step 6302, Visuphone 4104 of portable device 4102 searches for an external device 4106. For example, a Visuphone present in a smart phone searches for an external device such a large display screen, a laptop, a computer, and so forth. At step 6304, it is checked whether the external device is available. In an embodiment, the availability of external device is checked within a predefined distance such as within 50 meters, 10 meters, and so forth. If the external device is detected the portable device connects to the external device at step 6306, else control goes back to step 6302. Thereafter, at step 6308 contents of display screen of portable device 5202 are displayed at the connected external device. For example, when connected to a laptop, the content of smart phone is displayed on the laptop screen.

FIGS. 64A and 64B illustrates a flowchart for implementing a portable device 5202 in the environment 5200, in accordance with an embodiment of the invention. Portable device 5202 includes a Visuphone 5208. Visuphone 5208 is configured to detect and connect to one or more devices such as external devices 5206a-n, user device 5204, and so forth.

At step 6402, Visuphone 5208 searches for a user device 5204. At step 6404, it is checked whether user device 5204 is available. If user device 5204 is available than a connection is established between portable device 5202 and the detected user device 5204 at step 6406 else control goes back to the step 6402.

At step 6408, Visuphone 5208 of portable device 5202 searches for an external device 5206. At step 6410, it is checked whether the external device 5206 such as external device 5206b is available. If the external device 5206 is avail-

able, then the process control goes to step **6412** else the control goes back to step **6408**. At step **6412**, a connection is established between portable device **5202** and the detected external device **5206b**. Thereafter, contents of display of connected user device **5204** are displayed on a screen of the connected external device **5206b**. For example, contents of a mobile phone may be displayed on a screen of a television which is connected to the television via portable device **5202**.

FIG. **65** illustrates exemplary functioning of a Visuphone for displaying one or more contact options at a device, in accordance with an embodiment of the invention. Sometimes it may be desired by a caller to call specifically to a particular branch or department of a destination. For example, while calling for a restaurant the user may be interested in calling to a particular branch (or location) of the restaurant but the user might not be aware of the exact phone number of that branch. In an embodiment, when a user or caller dials a phone number of a destination, Visuphone of device such as mobile phone may display one or more contact options **6520a-n** along with the visual IVR menu associated with the dialed destination. Contact options **6520a-n** can be contact details or information associated with different branches (or locations) of the dialed destination. For example, if the user dials a phone number of a pizzeria (e.g. pizza hut), then the Visuphone will display visual IVR menu **6502** of the pizzeria as well as one or more contact options corresponding to the other branches of same pizzeria (of pizza hut).

Further, by clicking or selecting at least one contact option of contact options **6520a-n**, the user can connect to desired branch or department of the dialed destination (or pizzeria). In an embodiment, when the user selects a contact option **6520b**, a visual IVR menu associated with a particular branch or department of the dialed destination can be displayed at the device. In an embodiment, contact options **6520a-n** may include information such as, but not limited to, a phone number, an address, a department name, and so forth. In an embodiment, one or more contact options **6520a-n** can be a tab with a tab name such as department name. The user can select one contact option of contact options **6520a-n** based on the contact details or information. In an embodiment, the different branches of the dialed destination may have different IVR menus. Further, the user can switch the display on the screen of device (or device **102**) by selecting at least one contact option **6520**. Visuphone of device (device **102**) takes the appropriate action based on the selection made by the user. In an embodiment, when the user selects a contact option, a visual IVR menu of the selected contact option such as a particular department of the dialed destination is displayed.

Visual IVR menu **6502** may include various options **6504** to **6518**. The user can select one or more options from the displayed visual IVR menu. For example, the user can order a pizza by selecting option **6506** or by pressing 1-2 keys of keypad of device. In an embodiment, the user may switch directly to some other department or branch of the dialed destination by selecting at least one contact option from the displayed contact options **6520a-n**. Based on the selection, the display of device **102** may change.

FIG. **66** illustrates change of display at user device **102**, when a user selects a contact option, in accordance with an embodiment of the invention. As discussed with reference to FIG. **65**, when a user selects a contact option such as **6520b** of the contact options **6520a-n**, a visual IVR menu **6602** associated with the contact option **6520b** may be displayed at device **102**. Visual IVR menu **6602** may include various options **6604-6614**. For example, if the user selects a contact option corresponding to a home delivery department of the

dialed pizzeria, then visual IVR menu **6602** for home delivery can be displayed as shown. Visual IVR menu **6604** includes options such as for ordering pizza by selecting an option **6606** (in case of a touch screen enabled device) or by pressing a combination of keys i.e. 1-2 on keypad of device **102**. Similarly, the user may get status for previously placed order by selecting an option **6608**. The user can choose to talk to an executive by selecting option **6614**. Contact options **6520a-n** provides an option to the user for directly connecting to IVR system of the desired branch, this way time can be saved.

FIG. **67** illustrates an exemplary functioning of Visuphone for displaying one or more contact options at a device, in accordance with another embodiment of the invention. When a user dials a phone number of a destination, such as an XYZ airlines customer care, from device **102**. Then a visual IVR menu **6702** of the XYZ airlines can be displayed at screen of device **102**. Additionally, one or more contact options such as XYZ Domestic Airline Contact Option **6720a** and XYZ International Airline Contact Option **6720b** can be displayed at the screen of device **102**.

In an exemplary scenario, the user may be interested in contacting or knowing details of domestic airlines or international airlines department of XYZ Airlines specifically. The user may directly dial to these specific airline departments by selecting a related contact option from the displayed contact options. For example, the user can directly connect to domestic airlines IVR system of XYZ airlines by selecting the XYZ Domestic Airlines Contact Option **6720a**. After detecting the selection of option **6720a**, the Visuphone of device **102** can display a visual IVR menu associated with the Domestic Airlines department of XYZ airline as shown in FIG. **68**. Similarly, the user can select International Airlines Contact Option **6720b** to directly connect to the XYZ International Airlines department. Thereafter, the user can interact with the displayed visual IVR menu.

FIG. **68** illustrates change in display at device **102** based on selection of a contact option by a user of device **102**, in accordance with an embodiment of the invention. As discussed with reference to FIG. **67**, a visual IVR menu of XYZ airlines is displayed when the user dials a phone number of XYZ Airlines. One or more contact options **6720a-b** can also be displayed along with visual IVR menu **6702**. After detecting a selection of contact option from the user at device **102**, the Visuphone may display a visual IVR menu of the selected option. As shown, the visual IVR menu **6802** associated with domestic airlines department of XYZ is displayed when the user selects 'XYZ Domestic Airlines Contact Option' **6720a**. Visual IVR menu of XYZ domestic airlines includes multiple options such as a Booking option **6806**, a Status Inquiry option **6808**, an Other Inquiry option **6810**, and so forth. The user can interact with visual IVR menu **6802** by selecting one or more options of visual IVR menu **6802** from these options **6804** to **6818**. For example, the user can select a combination of keys 1-4-2 to directly talk to an executive. In an embodiment, device **102** may have a touch sensitive screen, in such as device the user can select option **6818**.

FIG. **69** illustrates a flow diagram illustrating an exemplary functioning of the Visuphone for displaying one or more contact options, in accordance with an embodiment of the invention. Device **102** includes a Visuphone for displaying a visual IVR menu associated with a dialed phone number of a destination. Further, the Visuphone can display one or more contact options on a screen of device **102**. Device **102** can be a telecommunication device that can connect directly to a Public Switched Telephone Network (PSTN) **110**. A person skilled in the art will appreciate, that device **102** can also connect to a private telephone exchange. Examples of device

102a include, but not limited to, a mobile phone, a Smartphone, a telephone, or any other device capable of voice or data communication. When caller **106** dials a phone number of a destination and connects to any destination from destinations **108a-n**, a visual IVR menu may be displayed at device **102**. Additionally, one or more contact options may also be displayed at device **102**. Contact options may include information describing one or more branches of the dialed destination.

At step **6902**, a user dials a phone number of a destination. At step **6904**, the Visuphone displays a visual IVR menu associated with the dialed phone number of the destination. At step **6906**, one or more contact options are also displayed at the screen of device **102**. In an embodiment, the Visuphone searches the database for contact options matching the phone number of the dialed destination and displays the contact options at device **102**. At step **6908**, a user selects at least one contact option from the displayed contact options as shown in FIG. **65** and FIG. **67**. Thereafter, at step **6910**, the display of the visual IVR menu at device **102** is changed based on the selection of the contact option. In an embodiment, a visual IVR menu associated with the selected contact option is displayed at device **102**. Thereafter, the user or caller may interact with the displayed visual IVR menu of the selected contact option.

Embodiments of the invention provide a method for establishing a communication session among a plurality of communication devices. A communication device may send a first section including first information or header information to a second communication device. A Visuphone at the communication device sends the first section. The communication device includes one or more visual IVR menus. The header information may include information such as Visuphone version, visual IVR menu ID, ACK bit, and so forth. In an embodiment, the communication device may receive an acknowledgement message based on the first section from the second communication device. The acknowledgement message is received when the second communication device includes a Visuphone. Thereafter, the Visuphone at the second communication device may send a second section or packet including a second information or payload to the second communication device. The payload may include information such as user ID, user profile, user selection, and so forth. Thereafter, a communication session is established between the communication device and the second communication device. In an embodiment, the second communication device may not include the Visuphone. In such a case the communication device and the second communication device communicates through DTMF signals or tones.

An aspect of the invention is to provide a system for communicating among a plurality of IVR enabled communication devices.

Another aspect of the invention is to enable the caller to interact with the visual IVR menu by using a touch sensitive screen of the device.

Another aspect of the invention is to provide the position based visual IVR menus in a communication network.

Another aspect of the invention is to provide a device for communicating with a second communication device. The device includes an IVR application such as Visuphone. In an embodiment, the second communication device also includes the IVR application such as Visuphone.

Another aspect of the invention is to provide the visual IVR menu when the call is forwarded from one first party device to another first party device.

Another aspect of the invention is to provide visual IVR menus on receiving a call from the first party device on electronic devices with screens that are connected to Visuphone.

Yet another aspect of the invention is that the user may involve other one or more users or communication devices in a call from a first party device. Thereafter, the user, the another user may interact with the first party device in a conference call. In an embodiment, the user may leave the conference call in between the call.

Additional aspect of the invention is to provide a method for establishing a communication session in a communication network. The communication session may be established between two or more IVR enabled devices.

Further aspect of the invention is to provide a method for establishing a communication session among a plurality of communication devices. The communication devices may or may not include Visuphone.

Another aspect of the invention is to provide a method for establishing a communication session among a plurality of communication devices. The communication session is established by sending one or more packets when a data network such as the Internet is available.

Another aspect of the invention allows a device to call a destination automatically according to the predefined calling information entered by a user.

Another aspect of the invention saves the effort made by the user of the communication device for retrieving information from an IVR system of the dialed destination. The Visuphone dials the phone number of the destination and retrieves the information automatically depending on the predefined calling information. Later, the user can use the retrieved information as per his/her convenience. In an embodiment, the user may not wish to use the information at the time of its retrieval. In such a case the information is stored and can be accessed later.

An advantage of the invention is that the communication device can send more information as data packets/messages to the second communication device by using a data network. The data packets may be exchanged among various communication devices. The data packet may include information required for establishing a communication session.

An advantage of an embodiment of the invention is that the user himself/herself does not have to dial the destination again and again for receiving information. Visuphone **104** present at device **102** of caller **106** may dial the phone number of the destination automatically based on the predefined calling information set by the caller **106**. Further, Visuphone **104** requests and receives the requested or inquired information automatically.

Another advantage of the invention is that the user does not have to wait for long time for retrieving any information from a destination. When the requested information is not available, the user may schedule a call at later time by entering few settings on device **102**. Thereafter, Visuphone **104** may dial the phone number of the destination according to the entered settings automatically and may download the desired information. The downloaded information may be used by the user at a later time.

Additional advantage of the invention relates to callers who are more proficient in foreign language. Visuphone may provide the visual IVR menu in multiple languages. A caller can than choose a language of his choice and download to his device database the menu in that language.

Yet another advantage of the invention relates to IVR that ask for voice commands. This IVR interface is for some caller harder to use due to accent or other problems. The database

could be provided with the option as been described before for the system to output voice command according to caller selection of the menu options.

Embodiments of the invention are described above with reference to block diagrams and schematic illustrations of methods and systems according to embodiments of the invention. It will be understood that each block of the diagrams and combinations of blocks in the diagrams can be implemented by computer program instructions. These computer program instructions may be loaded onto one or more general purpose computers, special purpose computers, or other programmable data processing translator to produce machines, such that the instructions which execute on the computers or other programmable data processing translator create means for implementing the functions specified in the block or blocks. Such computer program instructions may also be stored in a computer-readable memory that can direct a computer or other programmable data processing apparatus to function in a particular manner, such that the instructions stored in the computer-readable memory produce an article of manufacture including instruction means that implement the function specified in the block or blocks.

While the invention has been described in connection with what is presently considered to be the most practical and various embodiments, it is to be understood that the invention is not to be limited to the disclosed embodiments, but on the contrary, is intended to cover various modifications and equivalent arrangements included within the spirit and scope of the appended claims. The invention has been described in the general context of computing devices, phone and computer-executable instructions, such as program modules, being executed by a computer. Generally, program modules include routines, programs, characters, components, data structures, etc., that perform particular tasks or implement particular abstract data types. A person skilled in the art will appreciate that the invention may be practiced with other computer system configurations, including hand-held devices, multiprocessor systems, microprocessor-based or programmable consumer electronics, network PCs, mini-computers, mainframe computers, and the like. Further, the invention may also be practiced in distributed computing worlds where tasks are performed by remote processing devices that are linked through a communications network. In a distributed computing world, program modules may be located in both local and remote memory storage devices.

This written description uses examples to disclose the invention, including the best mode, and also to enable any person skilled in the art to practice the invention, including making and using any devices or systems and performing any incorporated methods. The patentable scope the invention is defined in the claims, and may include other examples that occur to those skilled in the art. Such other examples are intended to be within the scope of the claims if they have structural elements that do not differ from the literal language of the claims, or if they include equivalent structural elements with insubstantial differences from the literal languages of the claims.

The invention claimed is:

1. A method to enhance user interaction with Interactive Voice Response (IVR), the method comprising:
reading, from an IVR database, a menu corresponding to a telephone number being dialed from a keying element, wherein the IVR database comprises a list of telephone numbers,
wherein each telephone number has a corresponding menu,

wherein the telephone numbers are grouped based on one or more categories, and
wherein the IVR database is stored in a memory coupled to a processor;
displaying said menu on a display; and
displaying one or more advertisements based on the one or more categories related to the telephone number being dialed.

2. The method of claim **1**, wherein displaying said menu comprises displaying at least one icon within said menu.

3. The method of claim **1**, further comprising:
displaying a standard menu related to a category of the telephone number being dialed, and
translating at least one user keying to the corresponding selection according to the specific menu of the telephone number dialed.

4. The method of claim **1**, further comprising:
updating the IVR database in response to an indication given by a user.

5. The method of claim **1**, further comprising:
recording at least a portion of a telephone call to the telephone number being dialed, and
storing the portion in said memory in association with the telephone number being dialed.

6. The method of claim **1**, further comprising:
associating personal data with the telephone number being dialed in the IVR database in response to an indication given by a user.

7. A method for enhancing user interaction with Interactive Voice Response (IVR), the method comprising:
converting a user menu selection based on a standard menu to a corresponding selection of a specific menu for a telephone number being dialed according to an IVR database,
wherein the IVR database comprises a list of telephone numbers,
wherein each telephone number has a corresponding specific menu according to an associated IVR,
wherein the telephone numbers are grouped based on one or more categories for said associated IVR,
wherein at least one of said categories is associated with said standard menu, and
wherein said IVR database is stored in a memory coupled to a processor.

8. The method of claim **7**, further comprising:
associating an icon with at least one item of said standard menu.

9. The method of claim **7**, further comprising:
downloading updates for said database.

10. The method of claim **7**, further comprising:
using a wireless communication to transfer said standard menu to a display device.

11. The method of claim **7**, further comprising:
recording at least a portion of a telephone call conducted following said telephone number being dialed, and
storing said portion in said memory in association with said telephone number being dialed and the user menu selection.

12. The method of claim **7**, further comprising:
associating personal user data with said telephone number being dialed and the user menu selection.

13. The method of claim **7**, further comprising:
displaying at least one legal notice associated with said telephone number being dialed.

77

- 14.** A method for enhancing user interface with Interactive Voice Response (IVR), the method comprising:
 reading, from an IVR database, a menu related to a telephone number being dialed from a keying element, and displaying the menu on a display by displaying an icon for at least one of the menu's options, 5
 wherein the IVR database comprises a list of telephone numbers,
 wherein each telephone number has a corresponding menu according to an associated IVR, 10
 wherein said telephone numbers are grouped based on one or more categories for said associated IVR, and
 wherein said telephone numbers are stored in a memory coupled to a processor.
- 15.** The method of claim **14**, further comprising: 15
 using wireless communication to transfer the menu to the display.
- 16.** The method of claim **14**, further comprising:
 downloading updates for said IVR database.

78

- 17.** The method of claim **14**, further comprising:
 recording at least a portion of a telephone call conducted following said telephone number being dialed, and storing said portion in said memory in association with said telephone number being dialed and a menu selection made by a user.
- 18.** The method of claim **14**, comprising:
 associating personal user data with at least one telephone number from said list of telephone numbers.
- 19.** The method of claim **14**, further comprising:
 displaying one or more advertisements based on the one or more categories related to said telephone number being dialed according to said IVR database.
- 20.** The method of claim **14**, further comprising:
 displaying at least one legal notice associated with at least one telephone number being dialed from said list of telephone numbers.

* * * * *